

Genuine Spare Parts

www.stiga.com

MULTICLIP EURO 50 H Model Year 2012

- Use GLOBAL GARDEN PRODUCT Genuine Spare Parts specified in the parts list for repair and/or replacement.
- The contents described in the parts list may change due to improvement.
- The drawings of the spare parts are only indicative and might not represent the part in question exactly.
- The indications "right" - "left" - "front" - "rear" refer to the position of the operator when using the machine.
- When placing orders of parts for repair and/or replacement, make sure that the illustrated parts list is the one applying to the machine's year of manufacture, as shown on the identification plate attached to the machine.

© Copyright 2012 Global Garden Products

All content is subject to copyright by Global Garden Products and may not be reproduced in whole or in part by any means, electronic or otherwise, without prior written approval.

THIS INFORMATION IS NOT INTENDED FOR SALE OR RESALE, AND THIS NOTICE MUST REMAIN ON ALL COPIES.

STIGA®

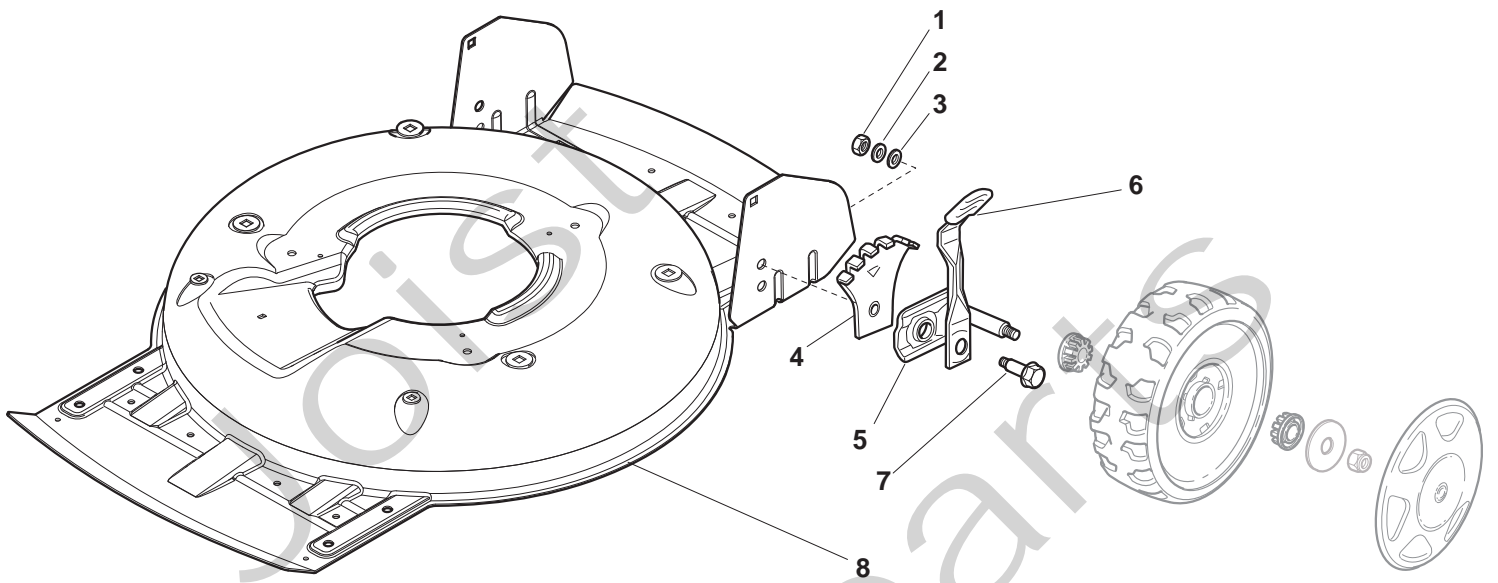

Position	Part No.	Q.Ty	Description
1	12293200/0	4	Nut
2	12583500/0	4	Grower
3	12523070/0	4	Washer
4	22735547/0	4	Sector, Height Adjustment
5	81005082/0	4	Support, Wheel
6	81003286/0	4	Lever, Height Adjustment
7	22519811/0	4	Pin
8	81002907/1	1	Deck Yellow

Joist
Spareparts
Joist

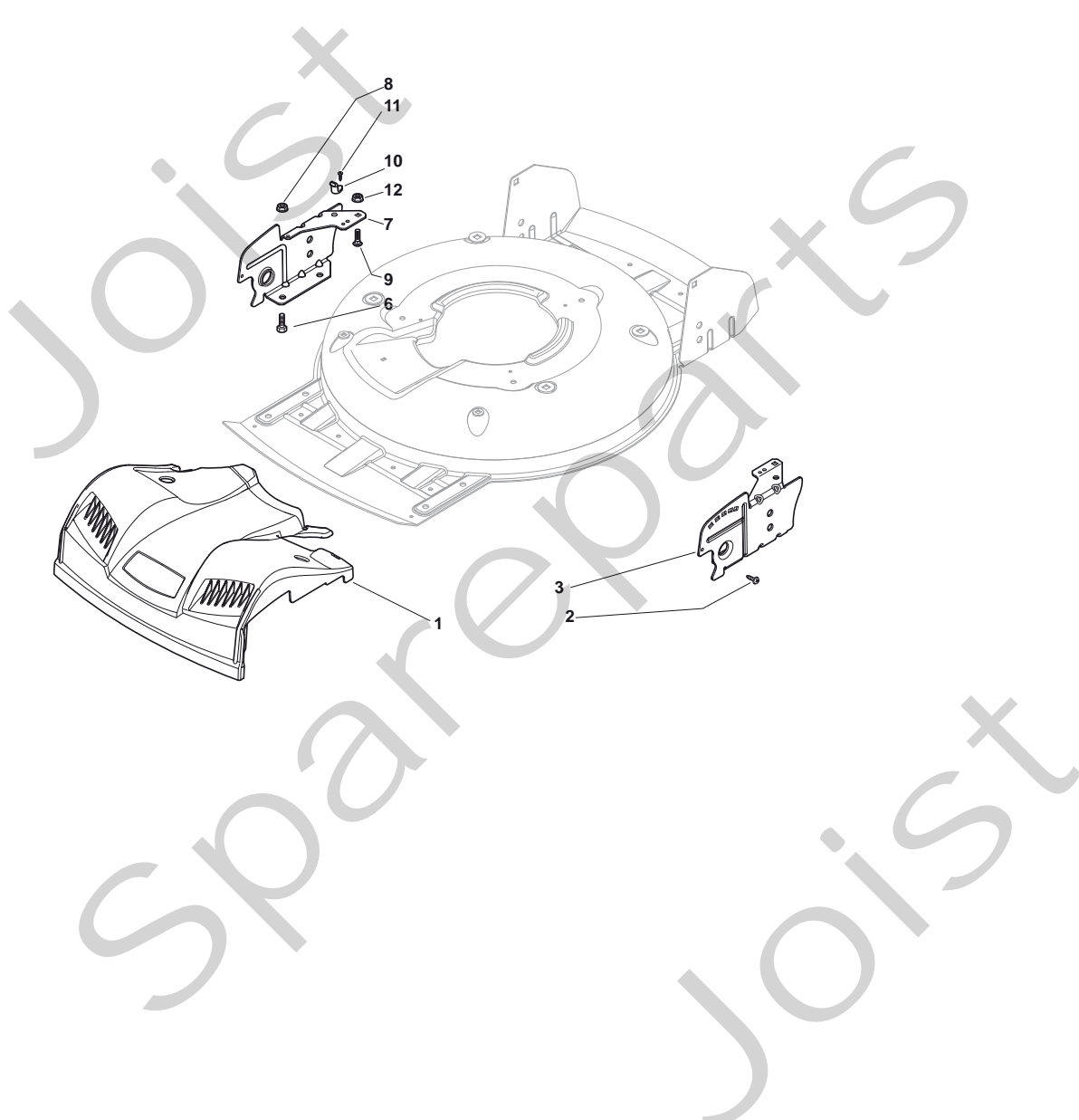

Position	Part No.	Q.Ty	Description
1	322226097/1	1	Mask, Yellow
2	12728523/0	2	Screw
3	22778421/0	1	Bracket, L
6	12792611/0	4	Screw
7	22778419/0	1	Bracket, R
8	12293201/0	4	Nut
9	12815200/0	2	Screw
10	22020400/0	2	Fairlead
11	12728523/0	2	Screw
12	12292102/0	2	Nut

Joist
Spareparts
Joist

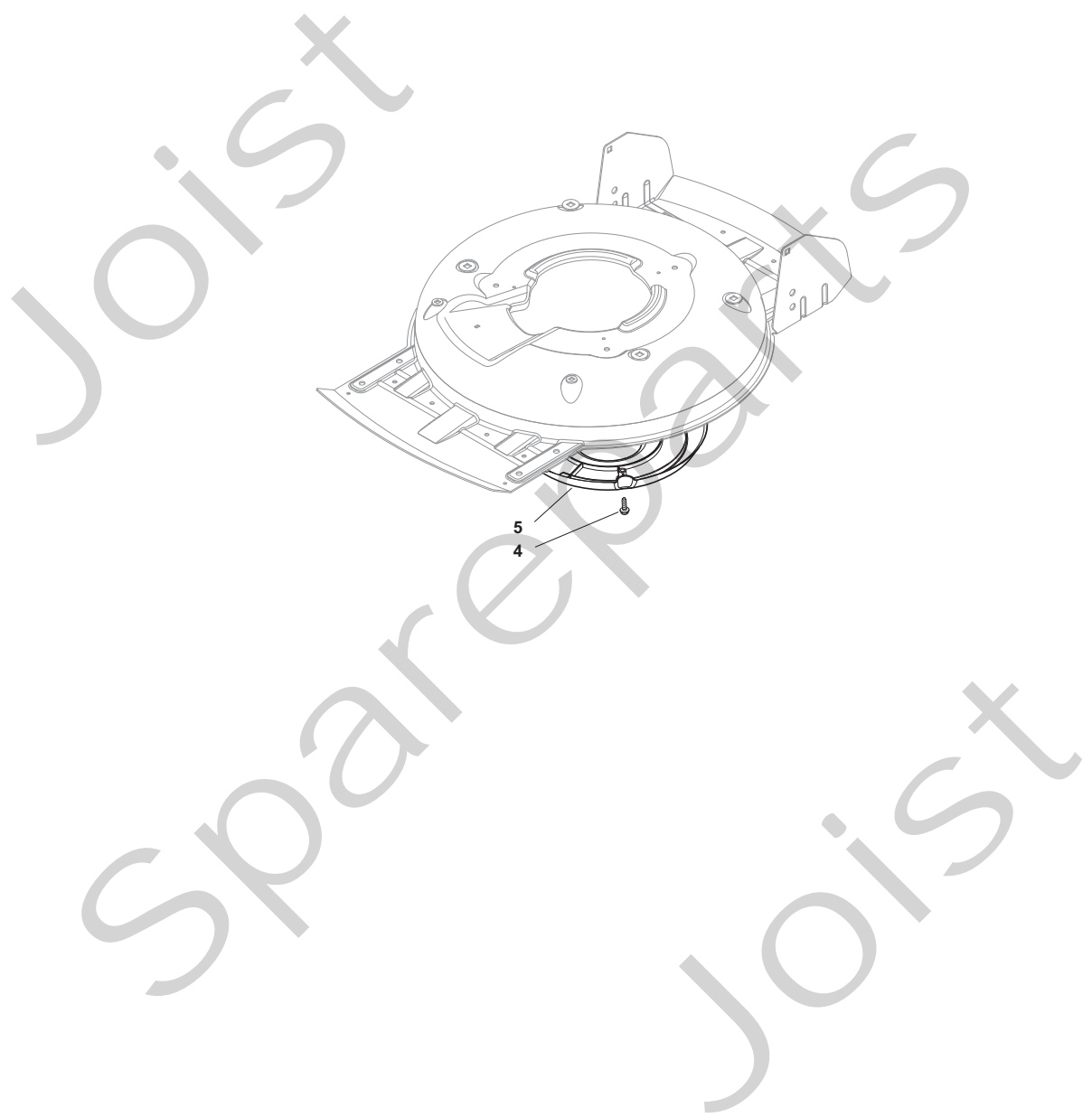

Position	Part No.	Q.Ty	Description
4	12728530/0	3	Screw
5	22060220/0	1	Protection

Joist
Spareparts
Joist

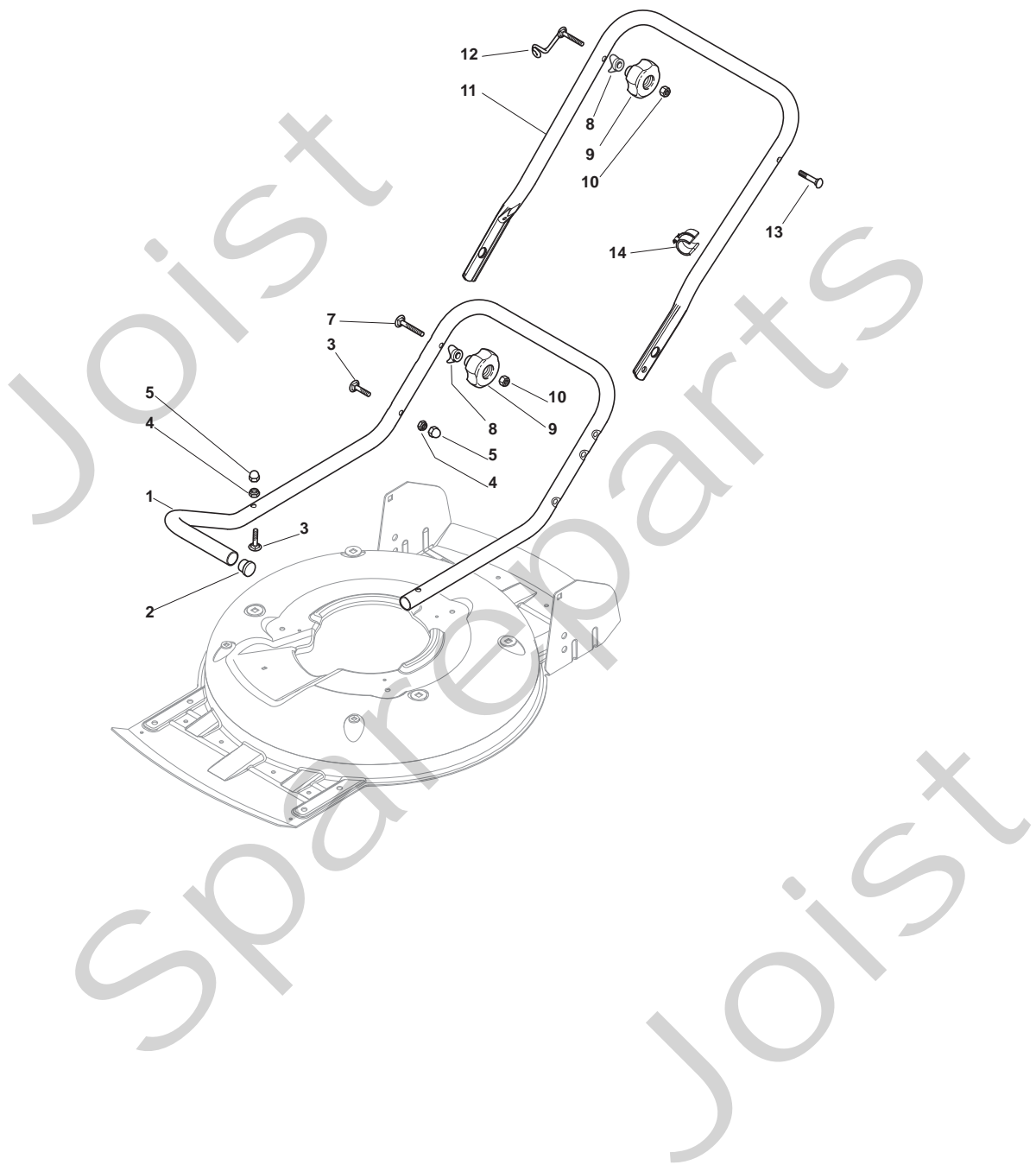

Position	Part No.	Q.Ty	Description
1	81006667/0	1	Handle, Lower Part
2	18566110/0	2	Cap
3	12818900/0	4	Screw
4	12155000/0	4	Nut
5	18203854/0	4	Protection
7	12819201/0	2	Screw
8	22680006/1	4	Washer
9	322399804/1	4	Knob
10	12293200/0	4	Nut
11	81006668/0	1	Handle, Middle Part
12	81003801/1	1	Guide Spring
13	12819201/0	1	Screw
14	118390020/0	1	Fairlead

Joist
Spareparts
Joist

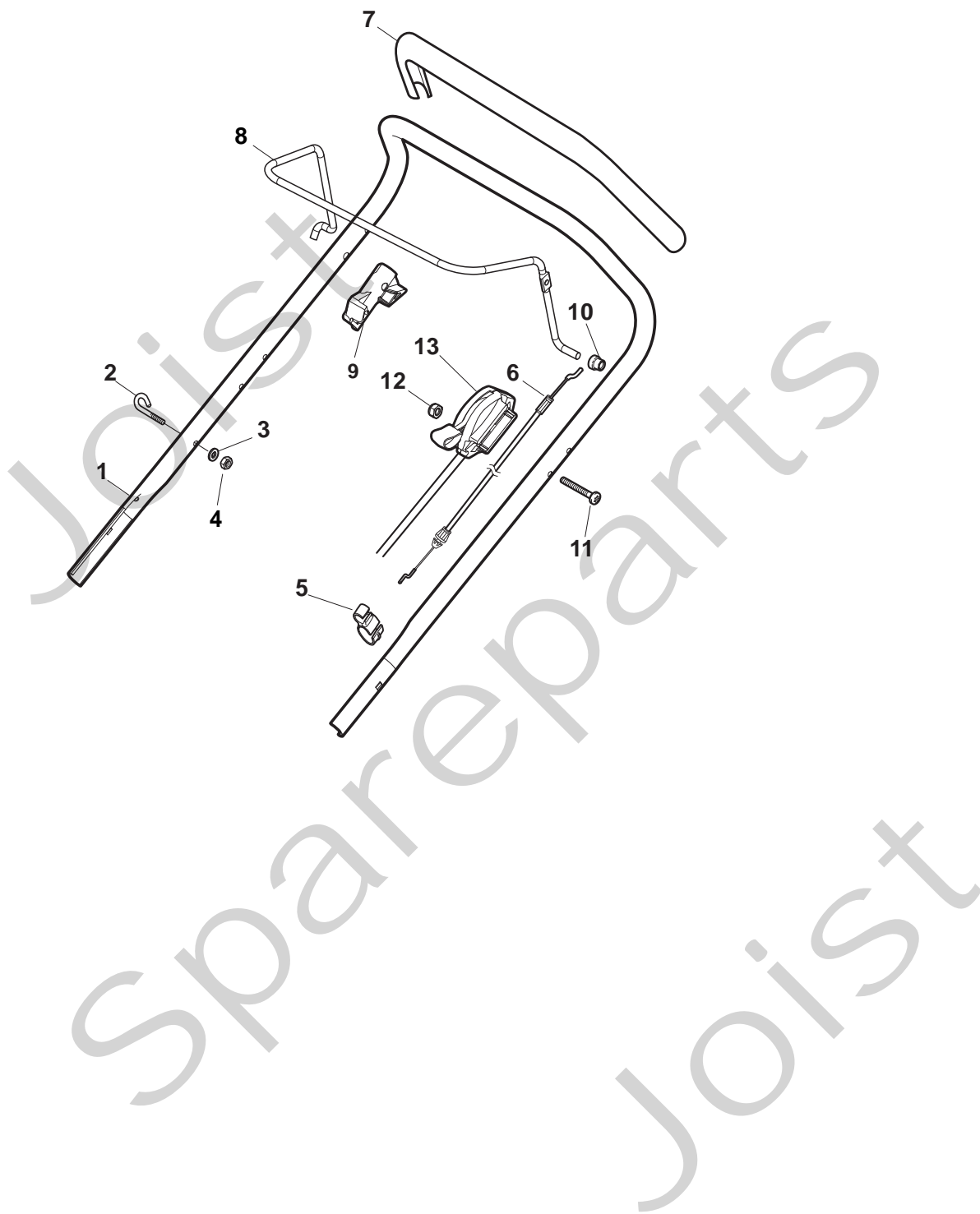

Position	Part No.	Q.Ty	Description
1	381007522/0	1	Handle, Upper Part
2	22430313/0	1	Guide Spring
3	12521330/0	1	Washer
4	12154510/0	1	Nut
5	118390020/0	1	Fairlead
6	181030056/0	1	Cable, Thread Engine Brake
7	22291050/0	1	Handgrip Black
8	181003300/1	1	Lever, Driving Black
9	322545204/0	1	Fulcrum Pin
10	22041966/0	2	Bush
11	12727783/0	1	Screw
12	12154510/0	1	Nut
13	181005517/0	1	Throttle Cable

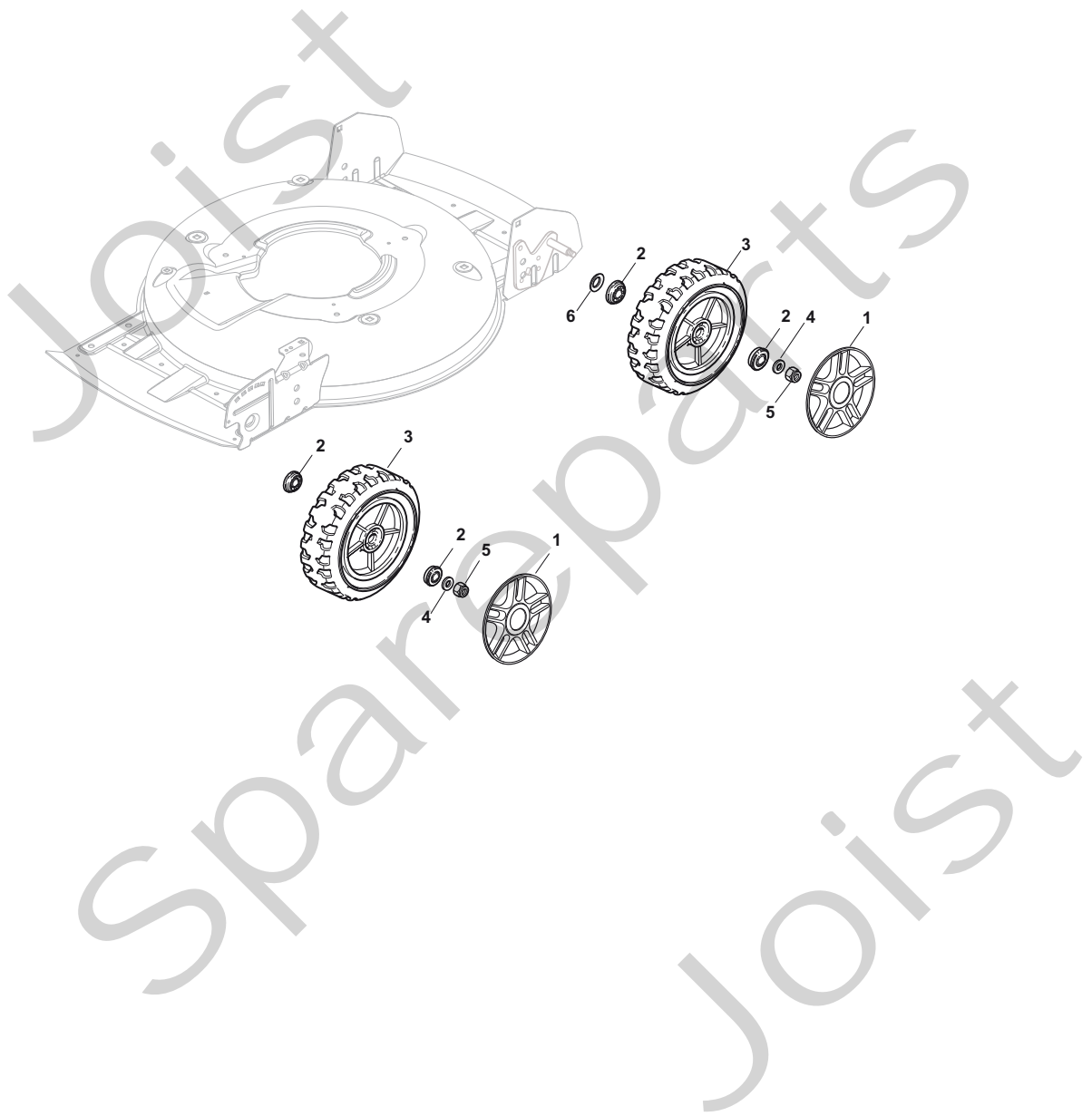

Position	Part No.	Q.Ty	Description
1	22110492/0	4	Hub Cap
2	22122200/0	8	Bearing
3	381007390/1	4	Wheel Ø 210
4	12521350/0	4	Washer
5	12155000/0	4	Nut
6	12530150/0	2	Elastic Washer

Joist
Spareparts
Joist

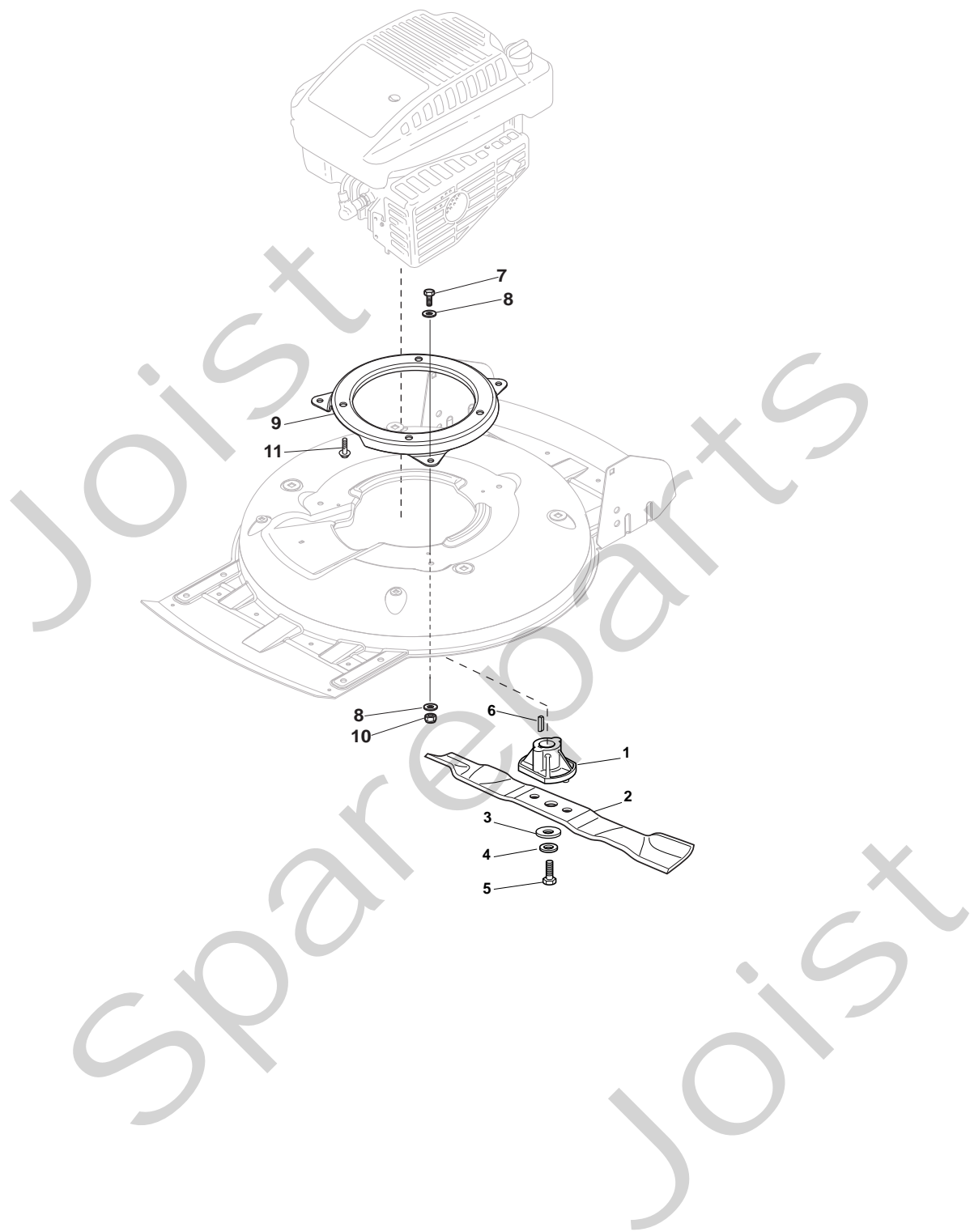

Position	Part No.	Q.Ty	Description
1	122463020/1	1	Hub, Crankshaft Ø 25
2	81004146/0	1	Blade Standard
3	22160400/0	1	Elastic Washer
4	12523080/0	1	Washer
5	12735698/0	1	Screw
6	12139150/0	1	Feather, Crankshaft Ø 25
7	12792611/0	3	Screw
8	12523060/0	6	Washer
9	322207219/1	1	Flange
10	12293201/0	3	Nut
11	112735108/1	3	Screw