

Genuine Spare Parts

www.stiga.com

SB 43 FS Model Year 2010

- Use GLOBAL GARDEN PRODUCT Genuine Spare Parts specified in the parts list for repair and/or replacement.
- The contents described in the parts list may change due to improvement.
- The drawings of the spare parts are only indicative and might not represent the part in question exactly.
- The indications "right" - "left" - "front" - "rear" refer to the position of the operator when using the machine.
- When placing orders of parts for repair and/or replacement, make sure that the illustrated parts list is the one applying to the machine's year of manufacture, as shown on the identification plate attached to the machine.

COPYRIGHT by GLOBAL GARDEN PRODUCTS

All rights reserved. No part of this material may be reproduced or transmitted, in any form or by any means, electronic or mechanical, including photocopying, recording or by any information storage and retrieval system, without permission in writing from GLOBAL GARDEN PRODUCTS.



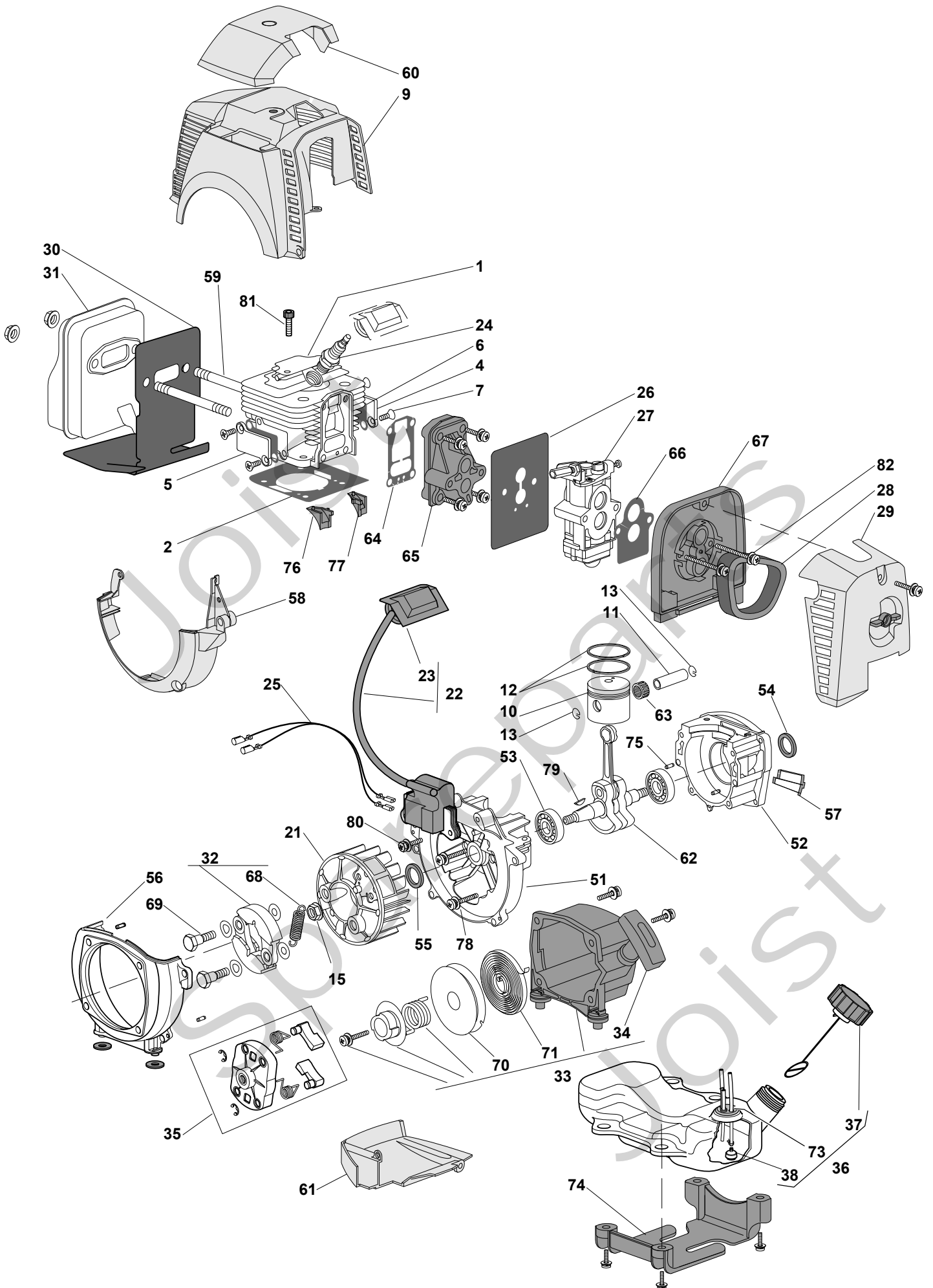



SB 43 FS - Model Year 2010

Pos. Fig.	Antal Quantity	Art No Part No	Benämning	Description	Anmärkning Notes
1	1	123071012/0	Cylinder	Cylinder	
2	1	123280051/0	Cylinderkåpa	Cylinder Gasket	
4	1	123109547/0	Kåpa	Cover	
5	1	123109548/0	Kåpa	Cover	
6	2	123280035/0	Tätningring	Gasket	
7	4	123878054/0	Skruv	Screw	
9	1	323106021/0	Motorlucka	Yellow Cylinder Cover	
10	1	123590006/0	Kolv	Piston	
11	1	123760003/0	Kolvbult	Piston Pin	
12	2	123204008/0	Kolvring	Piston Ring	
13	2	123202004/0	Låsring	Washer, Piston Pin	
15	1	123120005/0	Mutter	Nut	
21	1	123880007/0	Svånghjul	Flywheel	
22	1	123044013/0	Elektronikspole	Electronic Coil	
23	1	323053003/0	Tändstiftshatt	Spark Plug Cover	
24	1	3210024	Tändstift	Spark Plug	
25	1	183065029/0	Jordkabel	Earth Cable	
26	1	123280054/0	Packning	Intake-Carb Gasket	
27	1	123054031/0	Förgasare	Carburettor	
28	1	123220009/0	Luftfilter	Air Filter	
29	1	183090011/0	Luftfilterkåpa	Filter Cover, Yellow	
30	1	123280049/0	Packning	Gasket	
31	1	183740015/0	Ljuddämpare	Muffler	
32	1	183215006/0	Koppling	Clutch Ass.Y	
33	1	183058036/0	Start kpl	Starter Ass.Y	
34	1	123300007/0	Starthandtag	Starter Handle	
35	1	123082004/0	Startkopp	Starter Cup Ass.Y	
36	1	183733007/0	Bränsletank	Fuel Tank Ass.Y	
37	1	183790008/0	Tanklock	Fuel Cap Ass.Y	
38	1	183520004/0	Bränslefilter	Intake Filter	
51	1	123685009/0	Vevhus	Crank Case	
52	1	123685008/0	Vevhus	Crank Case	
53	2	114215217/0	Kullager	Bearing	
54	1	119035160/0	Tätningring	Seal Ring	
55	1	119035161/0	Tätningring	Seal Ring	
56	1	123208411/0	Transm.stödhus	Transm.Support Case	
57	1	123109561/0	Kåpa	Cover	
58	1	323109545/0	Kåpa	Case, Yellow	
59	2	123878062/0	Stud Screw	Double-Screw Bolt	
60	1	323109546/0	Tändstiftshatt	Yellow Cover, Spark Plug	
61	1	323600058/0	Skydd	Lower Guard, Yellow	
62	1	123020028/0	Vevaxel	Crankshaft	
63	1	123235005/0	Nållager	Needle Bearing	
64	1	123280053/0	Packning	Intake Manif-Gasket	
65	1	123073511/0	Insugningsrör	Intake Manifold	
66	1	123280055/0	Tätningring	Gasket	
67	1	123040001/0	Luftfilterhus	Air Cleaner Base	
68	1	123430587/0	Fjäder	Spring	
69	2	123878060/0	Skruv	Screw	
70	1	123604009/0	Linhjul	Starter Pulley	
71	1	123430590/0	Startfjäder	Spring	
73	1	123275022/0	Gummitätning	Grommet Ass.Y	
74	1	123784007/0	Skydd	Guard	
75	2	123753002/0	Sprint	Pin	
76	1	123294004/0	Guide	Guide	
77	1	123294005/0	Guide	Guide	
78	4	123878068/0	Skruv	Screw	
79	1	123072003/0	Vevaxel	Flywheel Key	
80	2	123878064/0	Skruv	Screw	



SB 43 FS - Model Year 2010

Pos. Fig.	Antal Quantity	Art No Part No	Benämning	Description	Anmärkning Notes
81	4	123878063/0	Skruv	Screw	
82	2	123878065/0	Skruv	Screw	

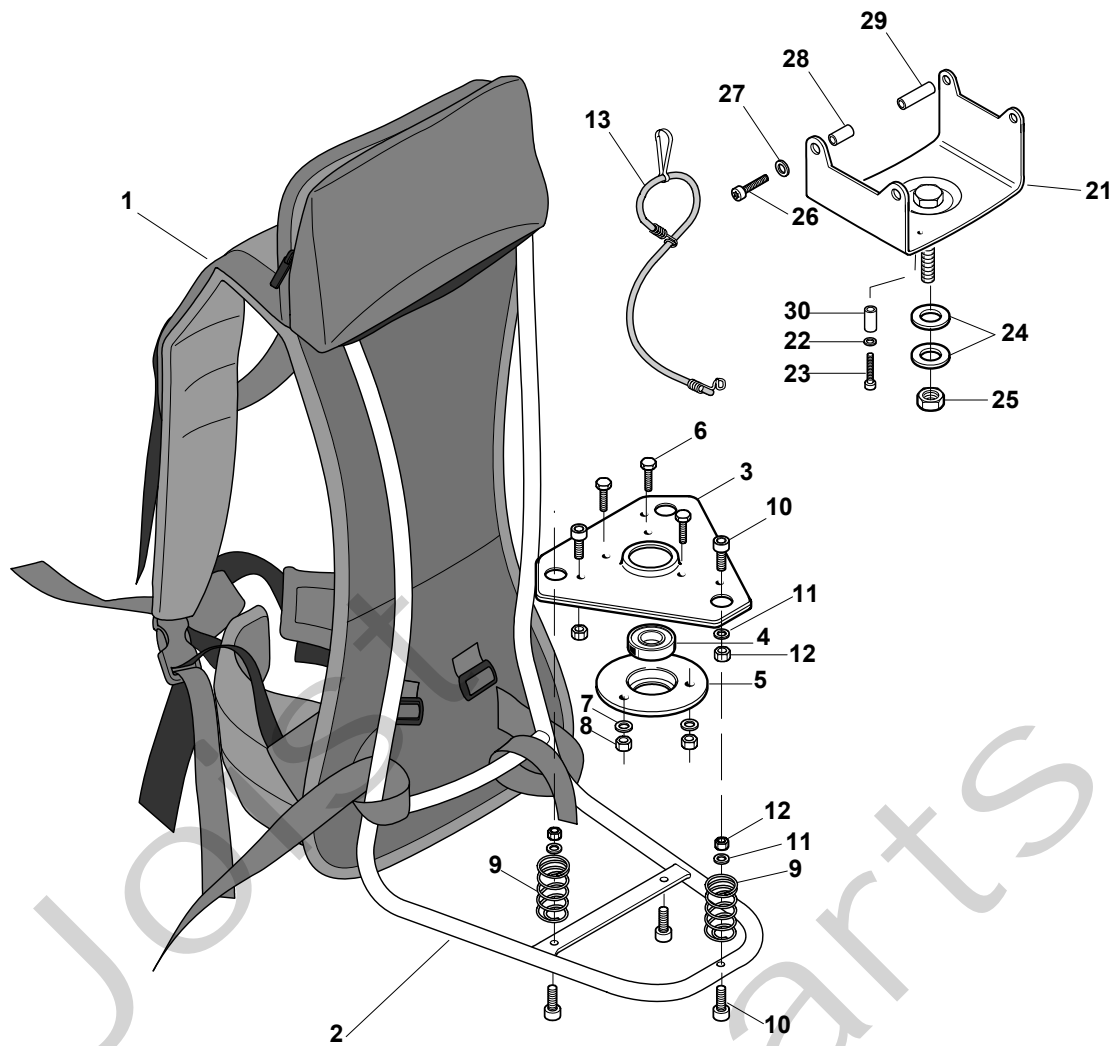

Pos. Fig.	Antal Quantity	Art No Part No	Benämning	Description	Anmärkning Notes
1	1	123046003/0	Sele	Harness	
2	1	383801101/0	Ryggfäste	Knap Sack Frame Ass.Y	
3	1	4612280	Platta	Engine Support	
4	1	3112170	Kullager	Bearing	
5	1	4612020	Lagernav	Bearing Flange	
6	3	2112260	Skruv	Screw	
7	3	2312090	Bricka	Washer	
8	3	2432040	Mutter	Nut	
9	3	3654360	Fjäder	Spring	
10	6	2132110	Skruv	Screw	
11	6	2312130	Bricka	Washer	
12	6	2432030	Mutter	Nut	
13	1	4252430	Elastic Cord	Elastic Cord	
21	1	383784001/0	Fläns	Flange (Flex)	
22	2	2312150	Bricka	Washer	
23	2	2135050	Skruv	Screw	
24	2	2330060	Bricka	Washer	
25	1	2412180	Mutter	Nut (Flex)	
26	4	2135200	Skruv	Screw	
27	4	2312090	Bricka	Washer	
28	2	123160056/0	Distans	Spacer	
29	2	123160057/1	Distans	Spacer	
30	2	123160058/0	Distans	Spacer	

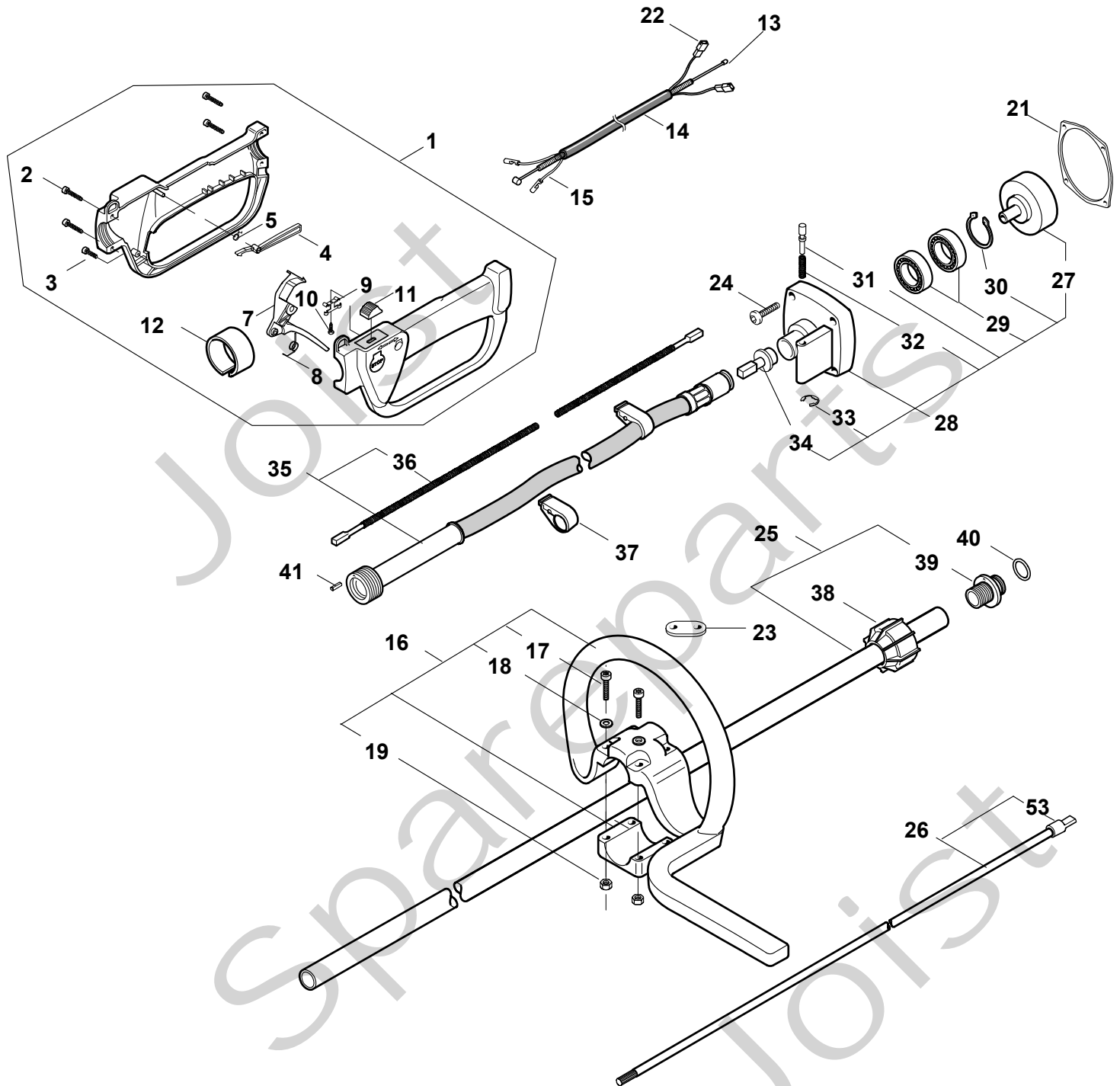



SB 43 FS - Model Year 2010

Pos. Fig.	Antal Quantity	Art No Part No	Benämning	Description	Anmärkning Notes
1	1	8562620/1	Handtag kpl	Handle Ass.Y (Incl.2-12)	
2	4	2123030	Skruv	Screw	
3	2	2123100	Skruv	Screw	
4	1	3743475	Säkerhetsspärr	Safety Lever	
5	1	3654300	Fjäder	Spring	
7	1	3743465	Gasreglage	Throttle Lever	
8	1	3654270/1	Fjäder	Spring	
9	1	3612710	Stopplatta	Stop Plate	
10	1	2123070	Skruv	Screw	
11	1	3749270	Stoppknapp	Stop Knob	
12	2	3750290	Reduktion	Reduction	
13	1	123066018/0	Gaswire	Wire Ass.Y	
14	1	3782680	Kabelhölje	Wire Sheath	
15	1	123065038/0	Kabel	Coil-Switch Cable (Red)	
16	1	8563600	Handtag-främre kpl	Front Handle Ass.Y (Incl.17-19)	
17	4	2135050	Skruv	Screw	
18	4	2312090	Bricka	Washer	
19	4	2412030	Mutter	Nut	
21	3	323208406/0	Fläns	Flange	
22	1	123065039/0	Jordkabel	Earth Cable (Black)	
23	1	3614980	Handle-Hole For Elastic Cord	Handle-Hole For Elastic Cord	
24	4	2135160	Skruv	Screw	
25	1	4252390	Drivaxelrör	Transm. Pipe Ass.Y (Incl.39)	
26	1	8630150	Drivaxel	Transm.Shaft Ass.Y (Incl.53)	
27	1	4121861/1	Kopplingshjul	Clutch	
28	1	8540910	Transmissionsstöd	Support Transm. (Incl.27,29-34)	
29	2	3112170	Kullager	Bearing	
30	1	3353080	Låsring	Seeger Ring	
31	1	3642420	Sprint	Pin	
32	1	3654170	Fjäder	Spring	
33	1	3351050	Låsring	Retainer	
34	1	3642430	Nav	Hub	
35	1	4122110/1	Flexaxel	Flex Shaft Ass.Y J (Incl.36)	
36	1	4253990/1	Flexaxel	Flexible Shaft J	
37	2	3749310	Clip	Clip	
38	1	3750270	Plate For Handle Fixing	Plate For Handle Fixing	
39	1	3643220	Flex Threaded Coupling R28	Flex Threaded Coupling R28	
40	1	3721540	O-ring	Or Ring	
41	1	3314040	Centrerstift	Centring Pin	
53	1	3642290	Axelhylsa	Flex Joint R28	

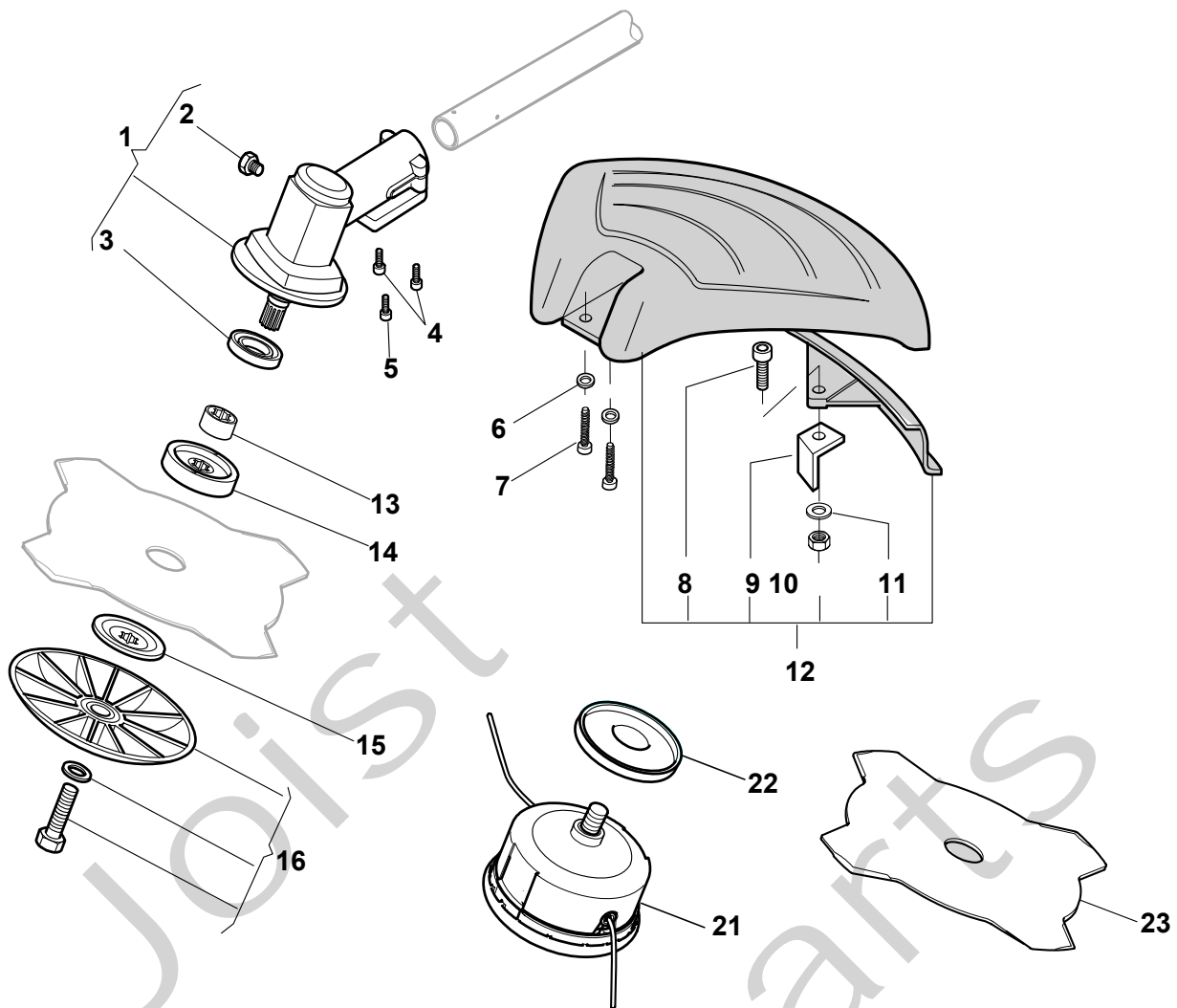

Pos. Fig.	Antal Quantity	Art No Part No	Benämning	Description	Anmärkning Notes
1	1	4252790/1	Snäckväxel kpl	Gear Case Assy R28	
2	1	2653460	Skruv	Screw	
3	1	3121170	Tätningring	Oil Seal	
4	2	2135050	Skruv	Screw	
5	1	2653090	Skruv	Screw	
6	2	2312150	Bricka	Washer	
7	2	2135060	Skruv	Screw	
8	1	2135030	Skruv	Screw	
9	1	3615000	Kniv	Line Cutter	
10	1	12154330/0	Mutter	Nut	
11	1	2312150	Bricka	Washer	
12	1	8563570	Stänkskydd kpl	Safety Cover Ass.Y (Incl.40-43)	
13	1	3641700/1	Krage	Collar	
14	1	3641640	Ringmutter-övre	Upper Ring Nut	
15	1	3612640	Ringmutter-nedre	Lower Ring Nut	
16	1	4560610	Stabilisator kpl	Stabilizer	
21	1	3L4353000/1	Skärhuvud kpl Profi	2 Hedges Nylon Head Profi	
22	1	3614950	Platta	Plate	
23	1	4611880	Röjklina	4 Teeth Disc 25 Cm	