

Genuine Spare Parts

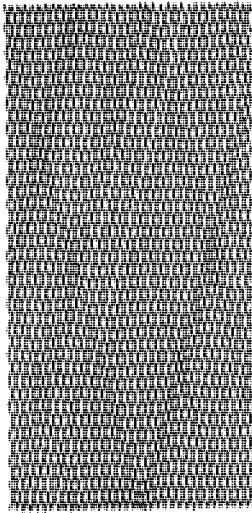

Spareparts
Joist

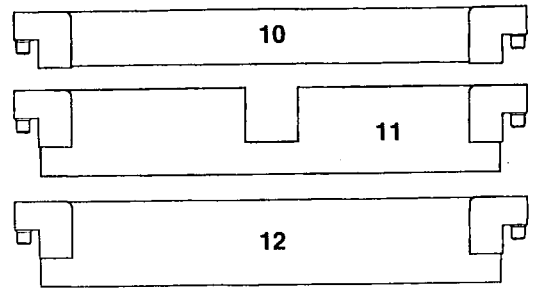
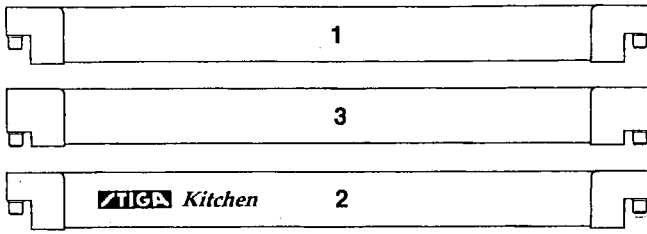

33

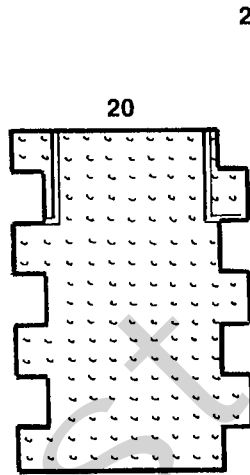

20

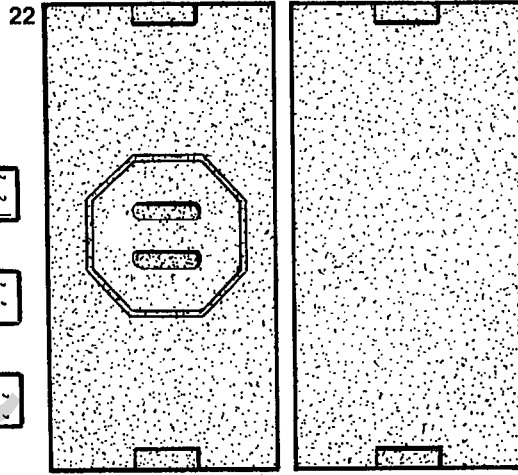

22

21

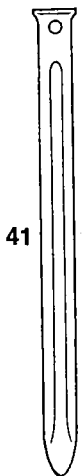

41

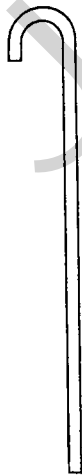

42



31



32

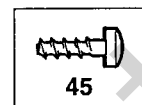

45

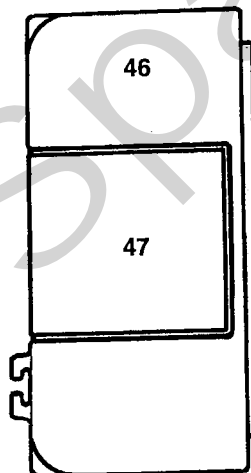

46

47

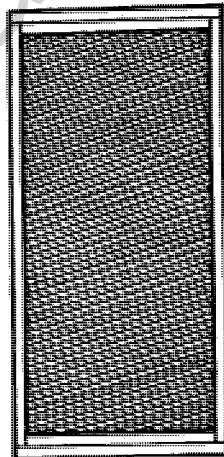

30

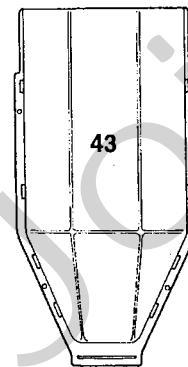

43

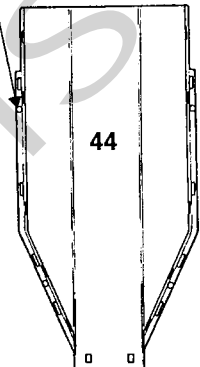

44

Utgåva Issue 2006- 12	Bildnr Picture No 921A	KITCHEN KOMPOSTBEHÅLLARE	KITCHEN COMPOST	Sida Page 236
-----------------------------	------------------------------	-----------------------------	--------------------	---------------------

Pos. Fig.	Antal/Quantity				Art nr Part No	Benämning	Description	Sats Kit	Anmärkning Notes
	3111								
1	10				1717-0327-01	Bräda	Board		
2	2				1717-0328-01	Bräda (m. logo)	Board (w. logo)		
3	2				1717-0167-03	Bräda	Board		
10	11				1717-0329-01	Bräda	Board		
11	1				1717-0175-01	Bräda- bakre	Board- rear		
12	1				1717-0174-01	Bräda- främre	Board- front		
20	10				1717-0211-01	Sidoisolering	Side insulator		
21	2				1717-0212-01	Toppisolering	Top insulator		
22	1				1717-0213-01	Toppisolering	Top insulator		
30	2				1717-0207-01	Jordfilter	Earth filter		
31	2				1717-0218-01	Matta	Mat		
32	1				1717-0208-01	Stöt	Plunger		
33	3				1717-0376-01	Nät	Net		
41	4				1717-0203-01	Jordspett	Earth nail		
42	2				1717-0288-01	Jordspett	Earth nail		
43	1				1717-0264-01	Tratt- främre	Hopper- front		
44	1				1717-0265-01	Tratt- bakre	Hopper- rear		
45	4				9836-9516-12	Skruv	Screw		
46	1				1717-0266-01	Lock	Cover		
47	1				1717-0267-01	Lucka	Flap		

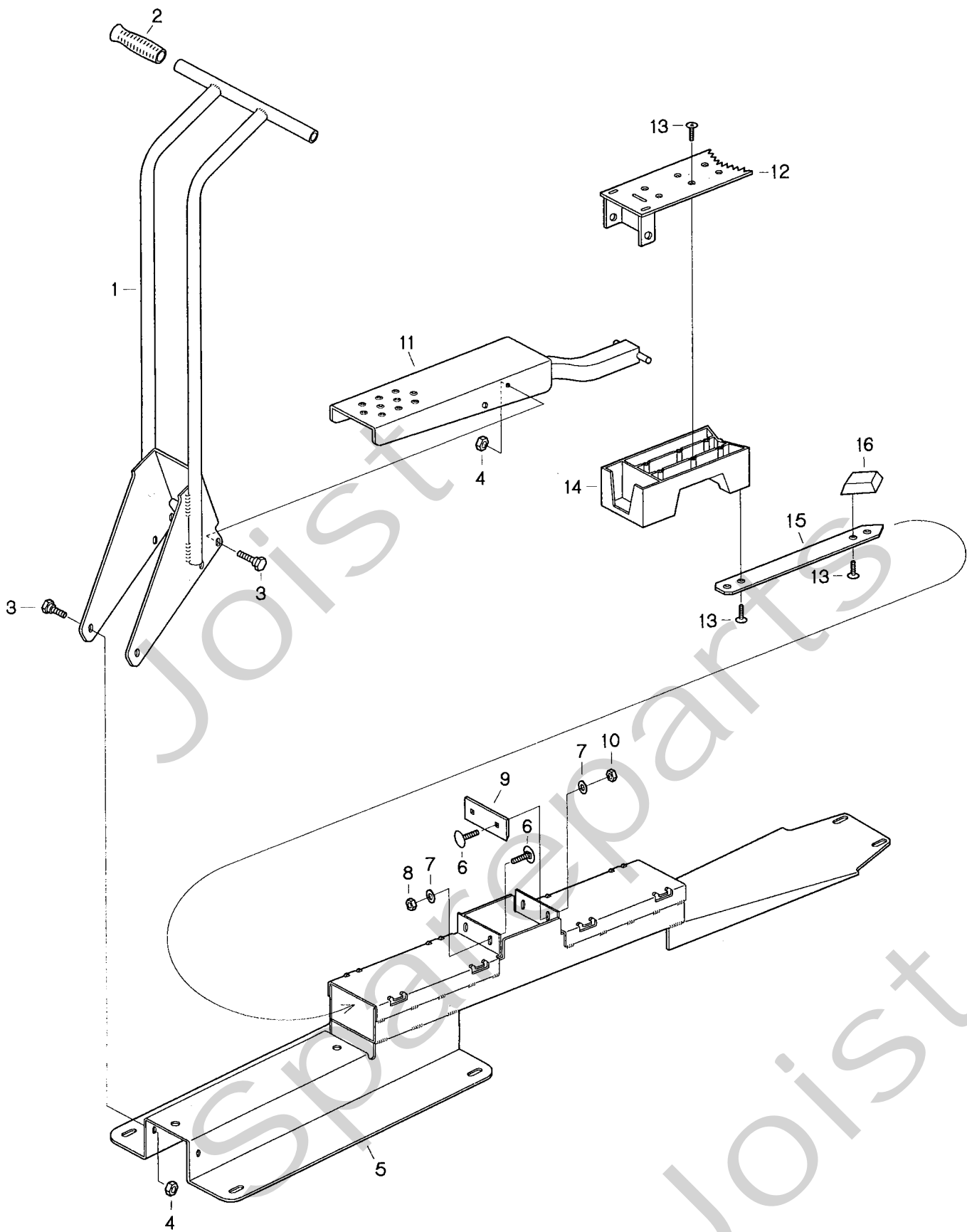

Utgåva Issue		Bildnr Picture No		KITCHEN KOMPOSTBEHÅLLARE INMATNINGSANORDNING		KITCHEN COMPOST FEEDING UNIT		Sida Page	
2006- 12		1002						238	
Pos. Fig.	Antal/Quantity			Art nr Part No	Benämning	Description	Sats Kit	Anmärkning Notes	
	3111								
0	1			1717-0247-01	Inmatningsenhet kpl	Feeder assy		Inkl. pos 3 - 16	
1	1			1717-0243-01	Styre	Handlebar			
2	2			9403-0114-70	Handtag	Handle			
3	4			1134-0240-00	• Ansattsskruv	• Shoulder screw			
4	4			9747-0831-02	• Mutter	• Lock nut			
5	1			1717-0248-01	• Rör	• Tube			
6	4			9897-0616-16	• Vagnsbult	• Carriage bolt			
7	4			9699-0060-02	• Planbricka	• Flat washer			
8	2			9739-0631-22	• Mutter	• Nut			
9	1			1717-0253-01	• Kniv (fast)	• Blade (fixed)			
10	2			9747-0631-02	• Låsmutter	• Lock nut			
11	1			1717-0257-01	• Pedal	• Pedal			
12	1			1717-0254-01	• Kniv (rörlig)	• Blade (movable)			
13	10			9831-9520-11	• Skruv	• Screw			
14	1			1717-0322-01	• Kolv	• Piston			
15	1			1717-0375-01	• Fäste	• Holder			
16	1			1717-0262-01	• Prisma	• Prism			