

Genuine Spare Parts

www.stiga.com

SILEX 50 Model Year 2010

- Use GLOBAL GARDEN PRODUCT Genuine Spare Parts specified in the parts list for repair and/or replacement.
- The contents described in the parts list may change due to improvement.
- The drawings of the spare parts are only indicative and might not represent the part in question exactly.
- The indications "right" - "left" - "front" - "rear" refer to the position of the operator when using the machine.
- When placing orders of parts for repair and/or replacement, make sure that the illustrated parts list is the one applying to the machine's year of manufacture, as shown on the identification plate attached to the machine.

COPYRIGHT by GLOBAL GARDEN PRODUCTS

All rights reserved. No part of this material may be reproduced or transmitted, in any form or by any means, electronic or mechanical, including photocopying, recording or by any information storage and retrieval system, without permission in writing from GLOBAL GARDEN PRODUCTS.



SILEX 50 - Model Year 2010

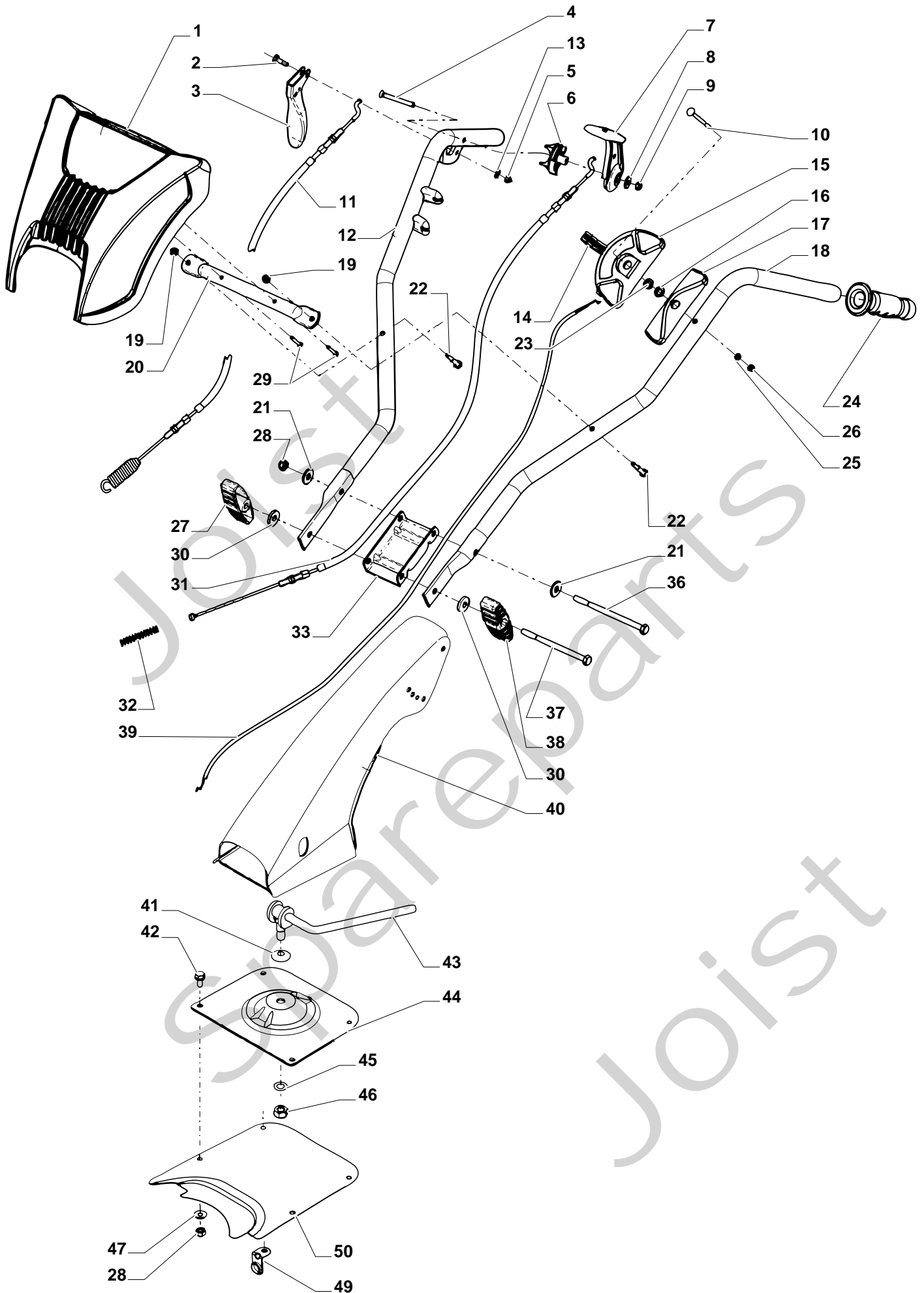



SILEX 50 - Model Year 2010

Pos. Fig.	Antal Quantity	Art No Part No	Benämning	Description	Anmärkning Notes
1	1	1483-2182-01	Panel-gul	Mask, Yellow	
2	1	1483-2005-01	Skruv	Pin	
3	1	1483-2008-01	Kopplingshandtag	Handle	
4	1	9948-0655-16	Skruv	Screw	
5	1	9747-0531-02	Mutter	Nut	
6	1	1483-2018-01	Stöd	Support	
7	1	1483-2017-01	Kopplingshandtag-back	Lever	
8	1	9699-0100-02	Bricka	Washer	
9	1	9747-0631-02	Mutter	Nut	
10	1	9898-0855-12	Skruv	Screw	
11	1	1483-2053-01	Kopplingswire	Cable	
12	1	1483-2178-01	Styrrör-hö	Handle (50R-B)	
12	1	1483-2179-01	Styrrör-hö	Handle (50-G / 50-H)	
13	1	9699-0025-02	Planbricka	Washer	
14	1	81007279/1	Gasarm	Lever, Throttle	
15	1	322981740/1	Gasreglage	Accelerator	
16	1	12508100/0	Låsbricka	Washer	
17	1	22171006/0	Distans	Spacer	
18	1	1483-2177-01	Styrrör-vä	Handle	
19	2	9747-0631-02	Mutter	Nut	
20	1	1483-2180-01	Panelstag	Bracket	
21	2	9699-0122-02	Bricka	Washer	
22	2	9997-0635-12	Skruv	Screw	
23	1	9699-0035-02	Planbricka	Washer	
24	2	1483-2079-01	Handtagsgrepp	Handgrip	
25	1	9699-0024-02	Planbricka	Washer	
26	1	9799-0531-02	Mutter	Nut	
27	1	1483-2006-01	Ratt m.mutter	Knob	
28	5	9747-0831-02	Mutter	Nut	
29	2	1483-2200-01	Skruv	Screw	
30	2	9699-0056-02	Planbricka	Washer	
31	1	1483-2051-01	Kopplingswire-back	Cable (50R-B)	
32	1	1483-2019-01	Fjäder	Spring (50R-B)	
33	1	1483-2046-01	Reduktion	Stiffening	
36	1	9997-0813-02	Skruv	Screw	
37	1	9997-0812-02	Skruv	Screw	
38	1	1483-2045-01	Ratt utan mutter	Knob	
39	1	1483-2181-01	Gaswire	Throttle Cable (75-G)	
40	1	1483-2042-01	Styrfäste-gul	Support Yellow	
41	3	1483-2073-01	Tallriksbricka	Washer	
42	4	9959-0820-16	Skruv	Screw	
43	1	1483-2044-01	Låshandtag	Lever	
44	1	1483-2043-01	Platta-gul	Plate Yellow	
45	1	9699-0121-02	Planbricka	Washer	
46	1	9747-1231-02	Mutter	Nut	
47	4	9699-0028-02	Planbricka	Washer	
49	1	1483-2021-01	Vinkelfäste	Support	
50	1	1483-2029-01	Platta-gul	Plate Yellow	

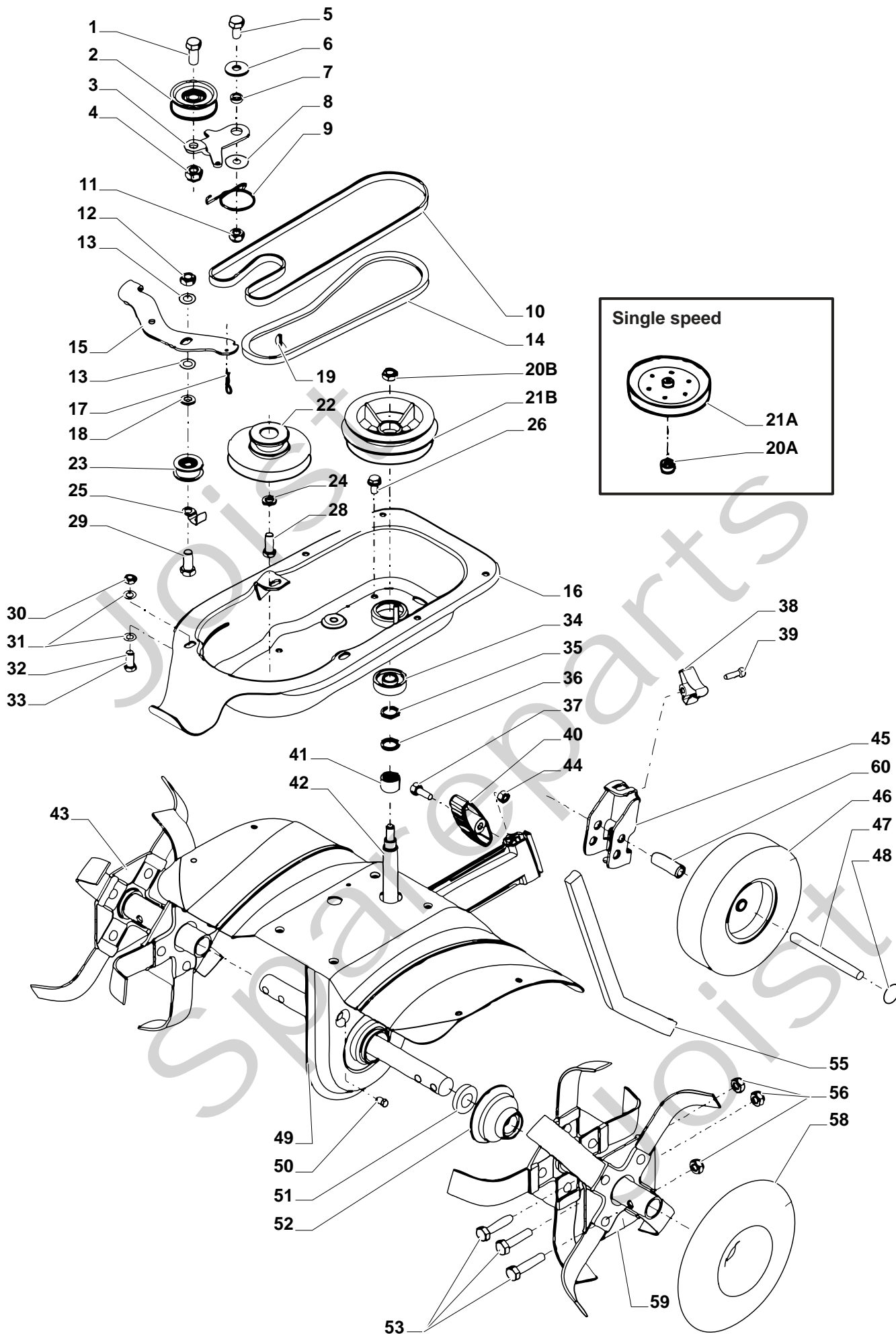



SILEX 50 - Model Year 2010

Pos. Fig.	Antal Quantity	Art No Part No	Benämning	Description	Anmärkning Notes
1	1	1483-2076-01	Skruv	Screw	
2	1	1483-2004-01	Spännrulle	Pulley	
3	1	1483-2032-01	Spännarm	Lever	
4	1	9747-1231-02	Mutter	Nut	
5	1	9997-1020-16	Skruv	Screw	
6	1	9699-0105-02	Bricka	Washer	
7	1	1483-2001-01	Bussning	Bush	
8	1	1483-2020-01	Distans	Spacer	
9	1	1483-2033-01	Returfjäder	Spring	
10	1	1483-2036-01	Drive belt	Belt (50R-B)	
11	1	9747-1031-02	Mutter	Nut	
12	2	9799-1031-02	Mutter	Nut	
13	2	9699-0035-02	Planbricka	Washer	
14	1	1483-2035-01	Drivrem-fram	Belt	
15	1	1483-2031-01	Spännarm-back	Lever (50R-B)	
16	1	1483-2040-01	Transm.hus-gul	Transm.housing-yellow	
17	1	9599-0052-02	Saxsprint	Cotter Pin	
18	2	9699-0035-02	Planbricka	Washer	
19	1	12139100/0	Kil	Key	
20A	1	1483-2027-01	Distans	Spacer (50-G / 50-H)	
20B	1	9799-1231-02	Mutter	Nut	
21B	1	1483-2025-01	Remskiva	Pulley (50R-B)	
21A	1	1483-2028-01	Remskiva	Pulley (50-G / 50-H)	
22	1	1483-2002-01	Remskiva	Pulley	
23	2	1483-2003-01	Spännrulle	Roll (50R-B)	
24	1	9699-0035-02	Planbricka	Washer	
25	1	1483-2030-01	Remstyrning	Belt Guide (50R-B)	
26	4	9959-0816-16	Skruv	Screw	
28	1	9987-5225-16	Skruv	Screw	
29	2	9997-1025-16	Skruv	Screw	
30	4	9747-0831-02	Mutter	Nut	
31	6	9699-0028-02	Planbricka	Washer	
32	1	9997-0835-12	Skruv	Screw	
32	3	9997-0840-16	Skruv	Screw L = 40 Mm	
33	2	9997-0860-16	Skruv	Screw L=60 Mm (50R-B)	
34	1	1483-2071-01	Kullager	Bearing	
35	1	1483-2068-01	Seegerring	Seeger	
36	1	1483-2000-01	Distans	Spacer	
37	1	9997-0820-16	Skruv	Screw	
38	1	1483-2060-01	Låsratt	Knob	
39	1	9997-0825-16	Skruv	Screw	
40	1	1483-2045-01	Ratt utan mutter	Knob	
41	1	1483-2072-01	Nållager	Needle Bearing	
42	1	1483-2026-01	Snäckskruv	Endless screw	
43	1	1483-2023-01	Rotor kpl-hö	Right Tine Assy	
44	1	9747-0831-02	Mutter	Nut	
45	1	1483-2056-01	Hjulstöd	Support	
46	2	1483-2061-01	Stödhjul	Wheel	
47	1	1483-2059-01	Hjulaxel	Axle, Wheels	
48	2	1483-2074-01	Låsning	Fastener	
49	1	1483-2039-01	Växelhus kpl-gul	Transm.housing-yellow	
50	1	1483-2075-01	Lock	Cap	
51	2	1483-2070-01	Tätningring	Oil Seal	
52	2	1483-2010-01	Dammskydd	Dust Cover	
53	6	9997-1050-16	Skruv	Screw	
55	1	1483-2064-01	Bromssporre	Lever	
56	6	9747-1031-02	Mutter	Nut	
58	2	1483-2022-01	Sidotallrik	Disc	
59	1	1483-2024-01	Rotor kpl-vä	Left Tine Assy	



SILEX 50 - Model Year 2010

Pos. Fig.	Antal Quantity	Art No Part No	Benämning	Description	Anmärkning Notes
60	2	1483-2062-01	Hjulhylsa	Spacer	

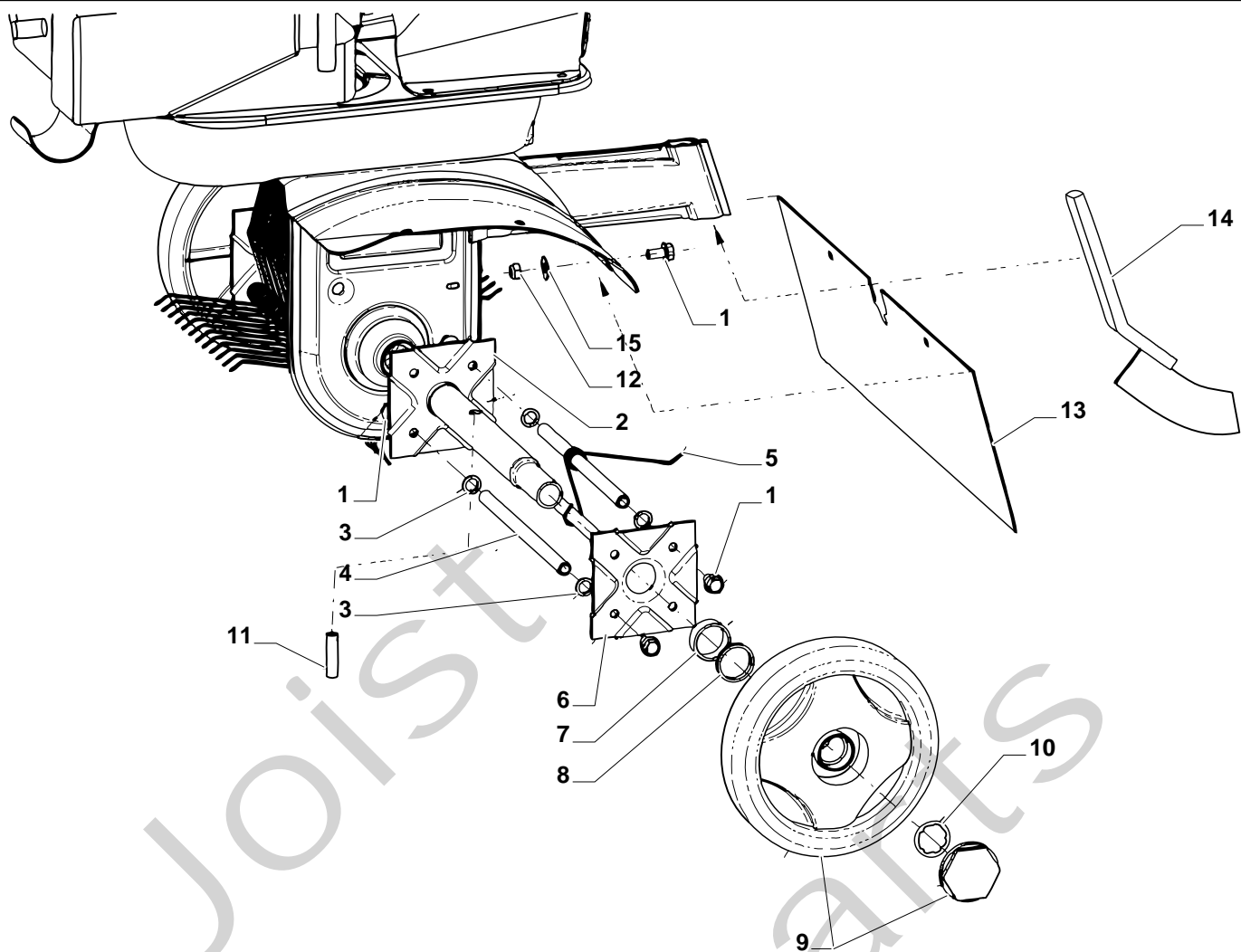
SILEX 50 - Model Year 2010

Pos. Fig.	Antal Quantity	Art No Part No	Benämning	Description	Anmärkning Notes
1	18	9959-0816-16	Skruv	Screw	
2	2	1483-2309-01	Fäste	Clamp	
3	16	9699-0121-02	Planbricka	Washer	
4	8	1483-2305-01	Axel	Shaft	
5	96	1483-2307-01	Fjäder	Spring	
6	2	1483-2301-01	Fläns	Flange	
7	2	1483-2310-01	Distansring	Spacer	
8	2	1483-2285-01	Distans	Spacer	
9	2	1483-2308-01	Hjul	Wheel	
10	2	1483-2322-01	Låsbricka	Crown Fastener	
11	2	1483-2324-01	Sprint	Pin	
12	2	9747-0831-02	Mutter	Nut	
13	1	1483-2320-01	Skyddsplåt	Cover	
14	1	1483-2319-01	Släpsko	Rod	
15	2	9699-0028-02	Planbricka	Washer	