

Genuine Spare Parts

www.stiga.com

ST 500 Model Year 2010

- Use GLOBAL GARDEN PRODUCT Genuine Spare Parts specified in the parts list for repair and/or replacement.
- The contents described in the parts list may change due to improvement.
- The drawings of the spare parts are only indicative and might not represent the part in question exactly.
- The indications "right" - "left" - "front" - "rear" refer to the position of the operator when using the machine.
- When placing orders of parts for repair and/or replacement, make sure that the illustrated parts list is the one applying to the machine's year of manufacture, as shown on the identification plate attached to the machine.

COPYRIGHT by GLOBAL GARDEN PRODUCTS

All rights reserved. No part of this material may be reproduced or transmitted, in any form or by any means, electronic or mechanical, including photocopying, recording or by any information storage and retrieval system, without permission in writing from GLOBAL GARDEN PRODUCTS.



Decespugliatori

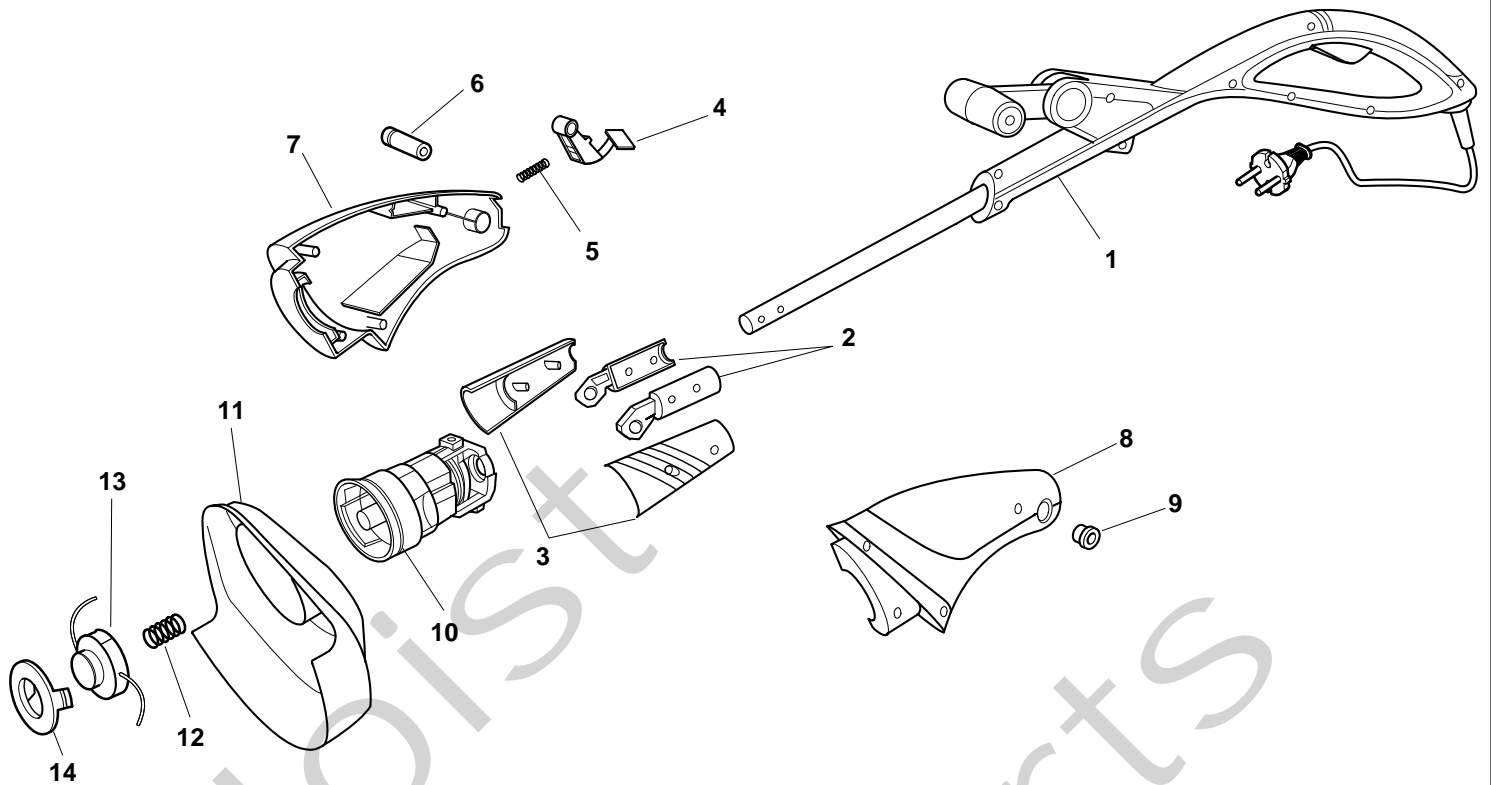

Pos. Fig.	Antal Quantity	Art No Part No	Benämning	Description	Anmärkning Notes
1	1	1911-1614-01	Handtag kpl	Motor Housing Yellow	
2	1	1911-1611-01	Led, vä+hö	Cover	
3	1	1911-1610-01	Ledklåpa, vä+hö	Joint	
4	1	1911-1609-01	Arm	Lever	
5	1	1911-1608-01	Fjäder	Spring	
6	1	1911-1607-01	Länkbult	Pin	
7	1	1911-1606-01	Växelhus-hö, gul	Right Housing, Yellow	
7	1	1911-1606-02	Växelhus-hö, röd	Right Housing, Red	
8	1	1911-1612-01	Växelhus-vä, gul	Left Housing, Yellow	
8	1	1911-1612-02	Växelhus-vä, röd	Left Housing, Red	
9	1	1911-1613-01	Lock	Cap	
10	1	1911-1630-01	Elmotor	Motor	
11	1	1911-1604-01	Skyddskåpa	Safety Cover Ass.Y	
12	1	1911-1629-01	Fjäder	Spring	
13	1	1911-1631-01	Skärhuvud kpl	Cutting Line Assy	
14	1	1911-1628-01	Knopp	Knob	