

Genuine Spare Parts

SB 51 FS

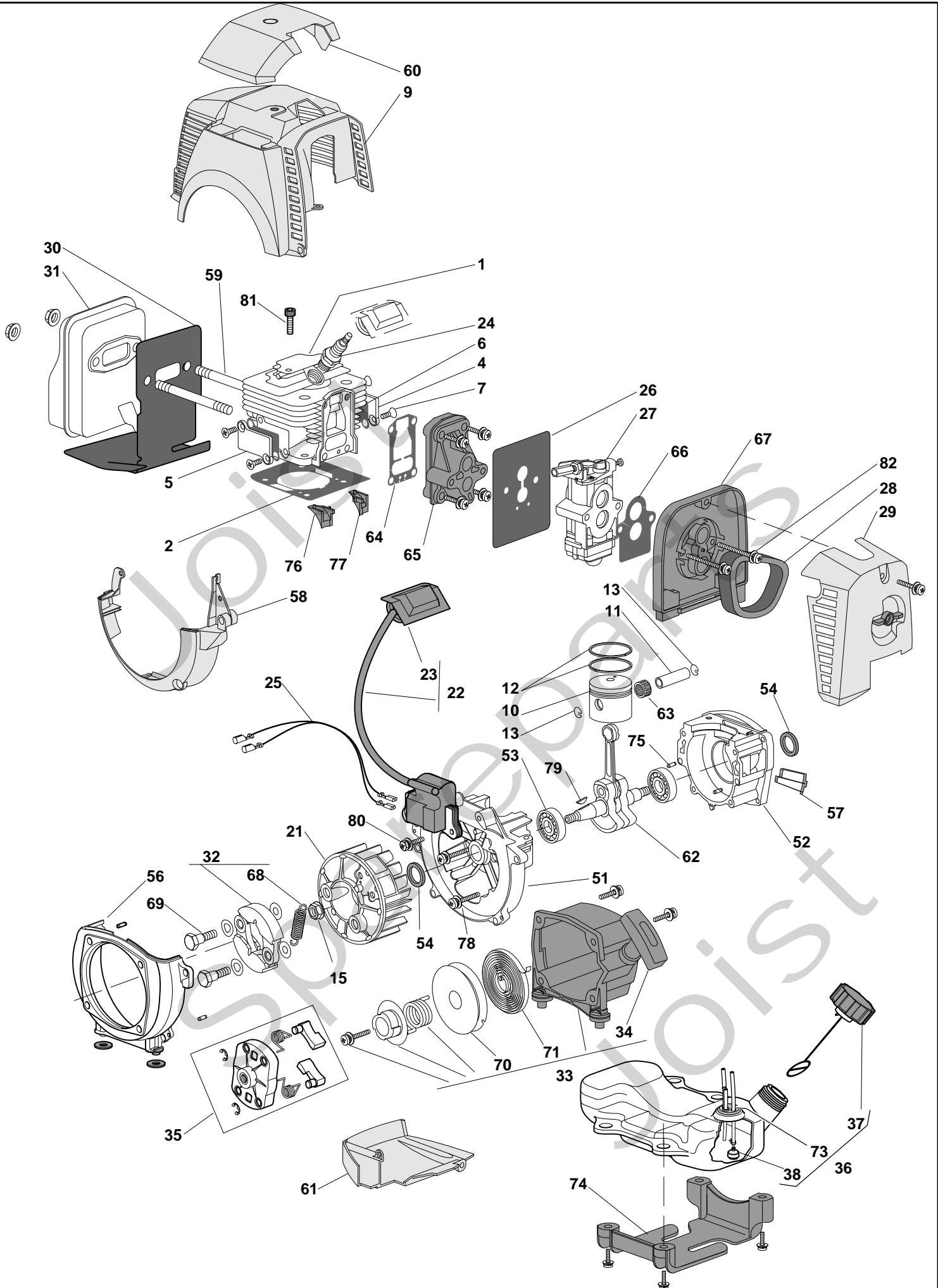





SB 51 FS - Model Year 2009

Pos. Fig.	Antal Quantity	Art No Part No	Benämning	Description	Anmärkning Notes
1	1	123071020/0	Cylinder	Cylinder	
2	1	123280051/0	Cylinderklåpa	Cylinder Gasket	
4	1	123109557/0	Kåpa	Cover	
5	1	123109558/0	Kåpa	Cover	
6	2	123280035/0	Packning	Gasket	
7	4	123878054/0	Skruv	Screw	
9	1	323106021/0	Motorlucka	Yellow Cylinder Cover	
10	1	123590011/0	Kolv	Piston	
11	1	123760004/0	Kolvbult	Piston Pin	
12	2	123204013/0	Kolvring	Piston Ring	
13	2	123202004/0	Låsring	Washer, Piston Pin	
15	1	123120005/0	Mutter	Nut	
21	1	123880007/0	Svånghjul	Flywheel	
22	1	123044014/0	Elektronikspole	Electronic Coil	
23	1	323053003/0	Tändstiftshatt	Spark Plug Cover	
24	1	3210024	Tändstift	Spark Plug	
25	1	183065029/0	Jordkabel	Earth Cable	
26	1	123280054/0	Packning	Intake-Carb Gasket	
27	1	123054032/0	Förgasare	Carburettor	
28	1	123220009/0	Luftfilter	Air Filter	
29	1	183090011/0	Luftfilterklåpa	Filter Cover, Yellow	
30	1	123280049/0	Packning	Gasket	
31	1	183740015/0	Ljuddämpare	Muffler	
32	1	183215007/0	Koppling	Clutch Ass.Y	
33	1	183058036/0	Start kpl	Starter Ass.Y	
34	1	123300007/0	Starthandtag	Starter Handle	
35	1	123082004/0	Startkopp	Starter Cup Ass.Y	
36	1	183733007/0	Bränsletank	Fuel Tank Ass.Y	
37	1	183790008/0	Tanklock	Fuel Cap Ass.Y	
38	1	183520004/0	Bränslefilter	Intake Filter	
51	1	123685009/0	Vevhus	Crank Case	
52	1	123685008/0	Vevhus	Crank Case	
53	2	114215217/0	Kullager	Bearing	
54	1	119035160/0	Tätning	Seal Ring	
55	1	119035161/0	Tätning	Seal Ring	
56	1	123208411/0	Transm.stödhus	Transm.Support Case	
57	1	123109561/0	Kåpa	Cover	
58	1	323109545/0	Kåpa	Case, Yellow	
59	2	123878062/0	Stud Skruv	Double-Screw Bolt	
60	1	323109546/0	Tändstiftshatt	Yellow Cover, Spark Plug	
61	1	323600058/0	Skydd	Lower Guard, Yellow	
62	1	123020028/0	Vevaxel	Crankshaft	
63	1	123235005/0	Nållager	Needle Bearing	
64	1	123280053/0	Packning	Intake Manif-Gasket	
65	1	123073512/0	Insugningsrör	Intake Manifold	
66	1	123280055/0	Packning	Gasket	
67	1	123040001/0	Luftfilterhus	Air Cleaner Base	
68	1	123430588/0	Fjäder	Spring	
69	2	123878060/0	Skruv	Screw	
70	1	123604009/0	Linhjul	Starter Pulley	
71	1	123430590/0	Startfjäder	Spring	
73	1	123275022/0	Gummitätning	Grommet Ass.Y	
74	1	123784007/0	Skydd	Guard	
75	2	123753002/0	Sprint	Pin	
76	1	123294004/0	Guide	Guide	
77	1	123294005/0	Guide	Guide	
78	4	123878068/0	Skruv	Screw	
79	1	123072003/0	Vevaxel	Flywheel Key	
80	2	123878064/0	Skruv	Screw	
81	4	123878063/0	Skruv	Screw	
82	2	123878065/0	Skruv	Screw	

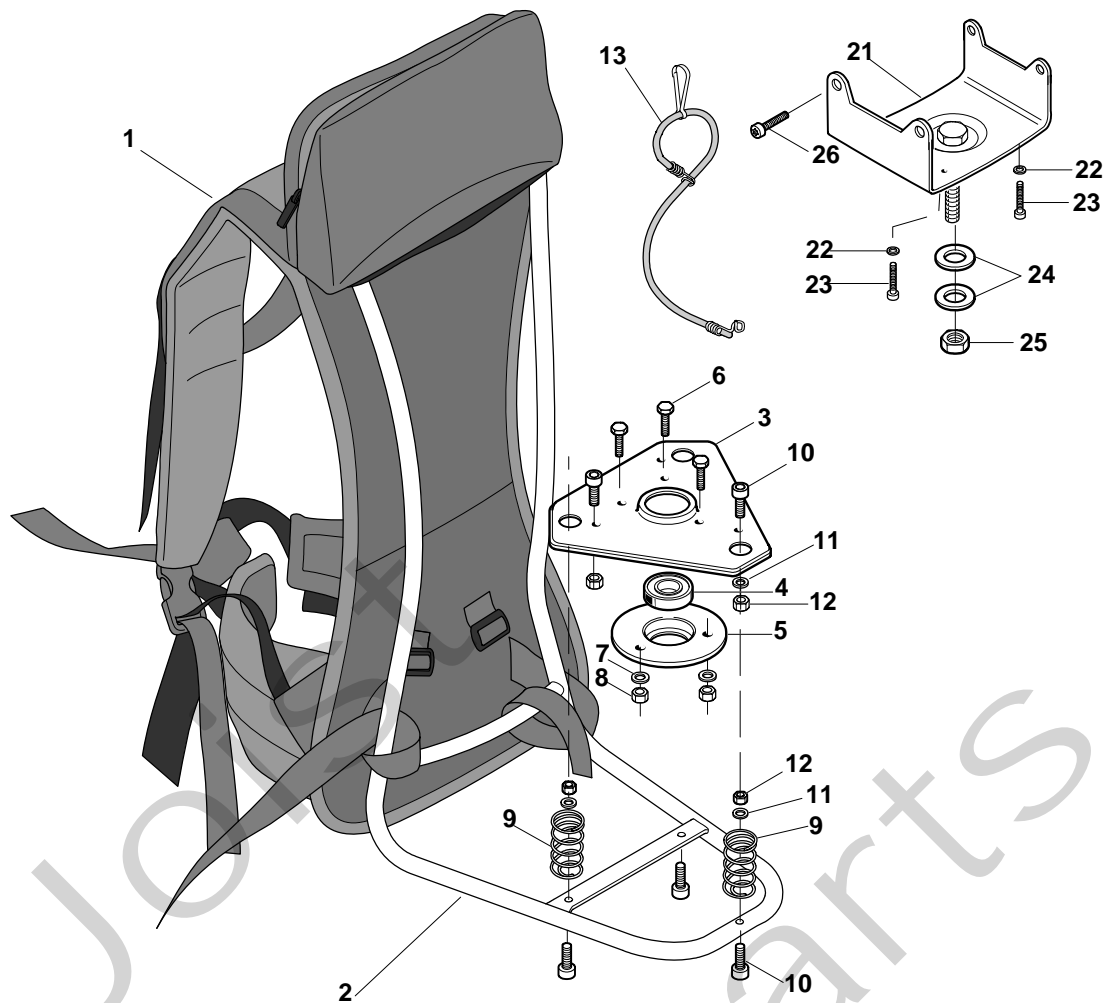

Pos. Fig.	Antal Quantity	Art No Part No	Benämning	Description	Anmärkning Notes
1	1	123046003/0	Sele	Harness	
2	1	383801101/0	Ryggfäste	Knap Sack Frame Ass.Y	
3	1	4612280	Platta	Engine Support	
4	1	3112170	Kullager	Bearing	
5	1	4612020	Lagernav	Bearing Flange	
6	3	2112260	Skruv	Screw	
7	3	2312090	Bricka	Washer	
8	3	2432040	Mutter	Nut	
9	3	3654360	Fjäder	Spring	
10	6	2132110	Skruv	Screw	
11	6	2312130	Bricka	Washer	
12	6	2432030	Mutter	Nut	
13	1	4252430	Elastic Cord	Elastic Cord	
21	1	383784001/0	Fläns	Flange (Flex)	
22	2	2330020	Bricka	Grower	
23	2	2135010	Skruv	Screw	
24	2	2330060	Bricka	Washer	
25	1	2412180	Mutter	Nut (Flex)	
26	2	2112310	Skruv	Screw	

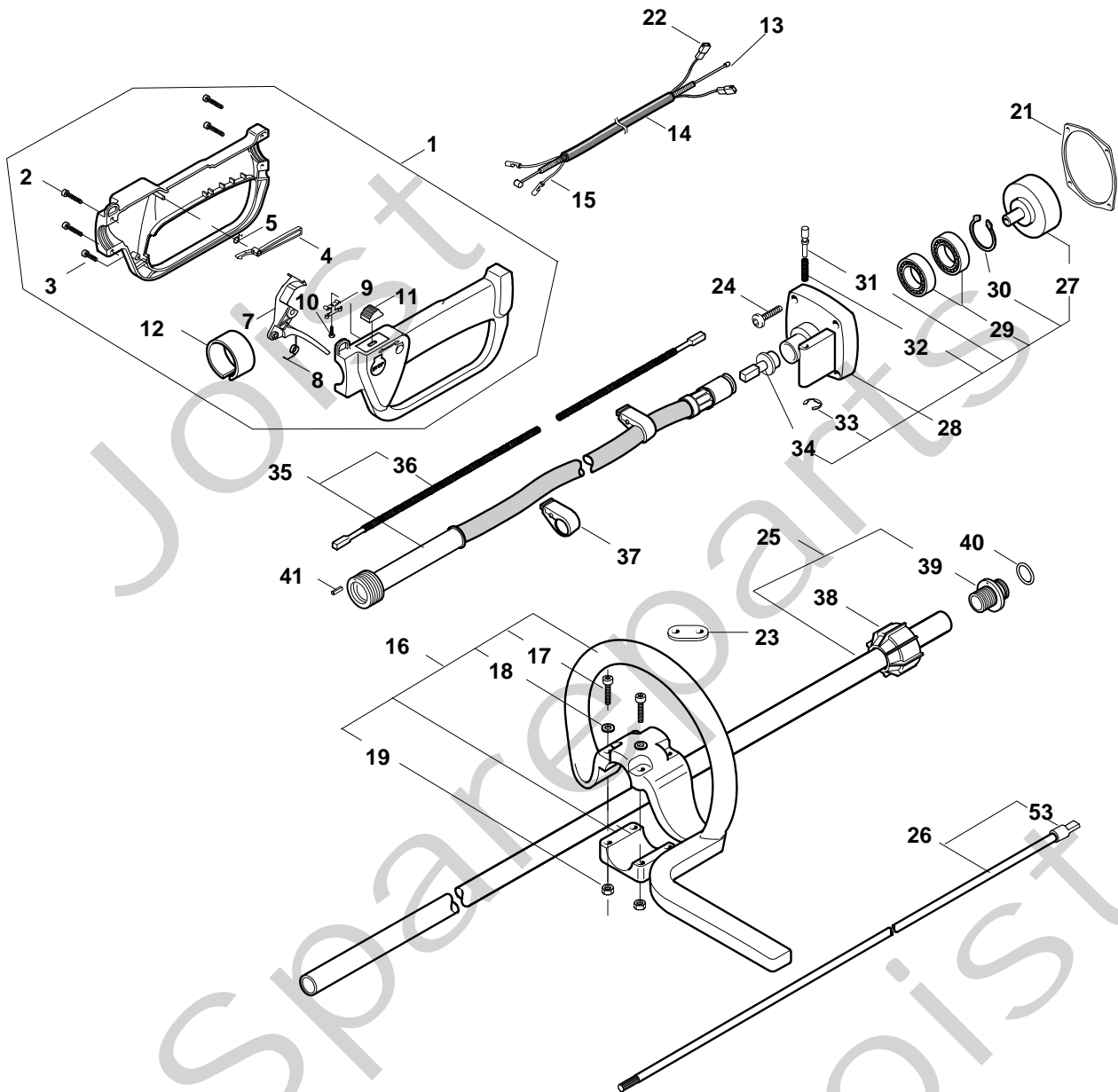



SB 51 FS - Model Year 2009

Pos. Fig.	Antal Quantity	Art No Part No	Benämning	Description	Anmärkning Notes
1	1	8562620/1	Handtag kpl	Handle Ass.Y (Incl.2-12)	
2	4	2123030	Skruv	Screw	
3	2	2123100	Skruv	Screw	
4	1	3743475	Säkerhetsspärr	Safety Lever	
5	1	3654300	Fjäder	Spring	
7	1	3743465	Gasreglage	Throttle Lever	
8	1	3654270/1	Fjäder	Spring	
9	1	3612710	Stopplatta	Stop Plate	
10	1	2123070	Skruv	Screw	
11	1	3749270	Stoppknapp	Stop Knob	
12	2	3750290	Reduktion	Reduction	
13	1	123066018/0	Gaswire	Wire Ass.Y	
14	1	3782680	Kabelhölje	Wire Sheath	
15	1	123065038/0	Kabel	Coil-Switch Cable (Red)	
16	1	8563600	Handtag-främre kpl	Front Handle Ass.Y (Incl.17-19)	
17	4	2135050	Skruv	Screw	
18	4	2312090	Bricka	Washer	
19	4	2412030	Mutter	Nut	
21	3	323208406/0	Fläns	Flange	
22	1	123065039/0	Jordkabel	Earth Cable (Black)	
23	1	3614980	Handle-Hole For Elastic Cord	Handle-Hole For Elastic Cord	
24	4	2135160	Skruv	Screw	
25	1	4252390	Drivaxelrör	Transm. Pipe Ass.Y (Incl.39)	
26	1	8630150	Drivaxel	Transm.Shaft Ass.Y (Incl.53)	
27	1	4121861/1	Kopplingshjul	Clutch	
28	1	8540910	Transmissionsstöd	Support Transm. (Incl.27,29-34)	
29	2	3112170	Kullager	Bearing	
30	1	3353080	Låsring	Seeger Ring	
31	1	3642420	Sprint	Pin	
32	1	3654170	Fjäder	Spring	
33	1	3351050	Låsring	Retainer	
34	1	3642430	Nav	Hub	
35	1	4122110/1	Flexaxel	Flex Shaft Ass.Y J (Incl.36)	
36	1	4253990/1	Flexaxel	Flexible Shaft J	
37	2	3749310	Clip	Clip	
38	1	3750270	Plate For Handle Fixing	Plate For Handle Fixing	
39	1	3643220	Flex Threaded Coupling R28	Flex Threaded Coupling R28	
40	1	3721540	O-ring	Or Ring	
41	1	3314040	Centrerstift	Centring Pin	
53	1	3642290	Axelhylsa	Flex Joint R28	

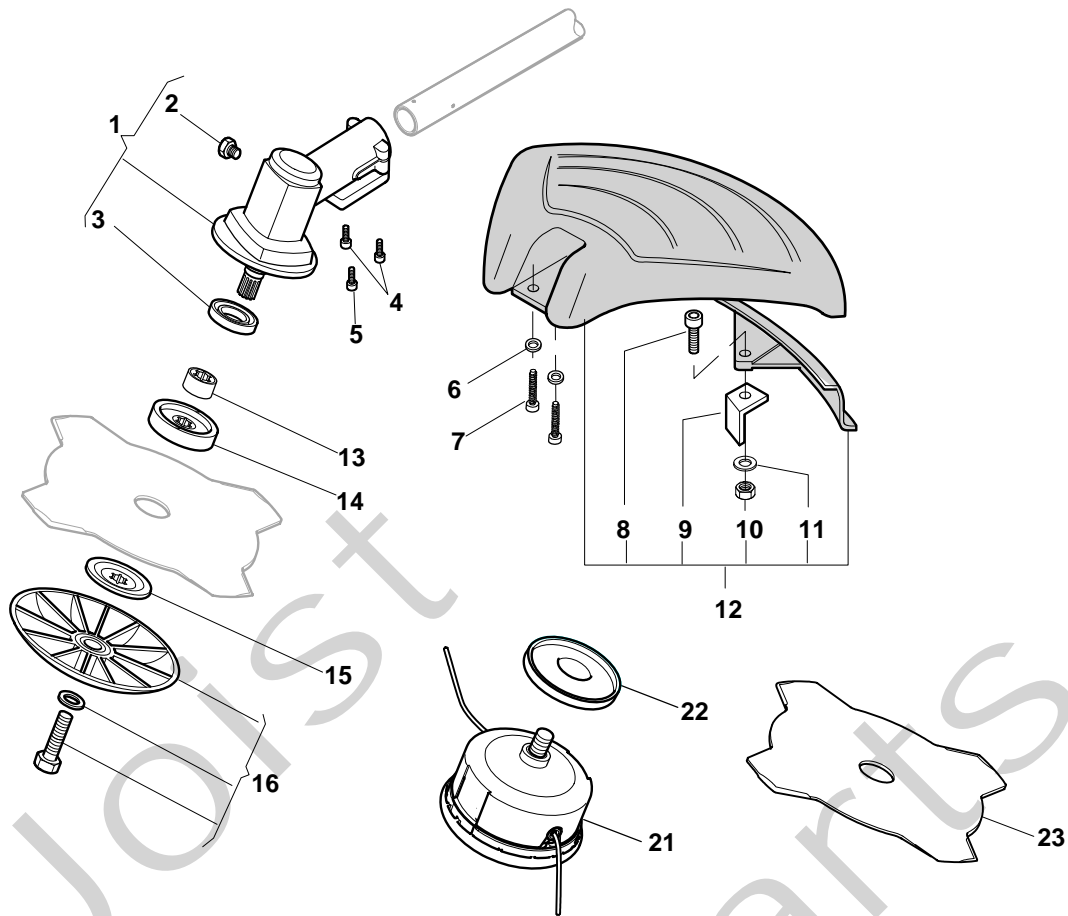

Pos. Fig.	Antal Quantity	Art No Part No	Benämning	Description	Anmärkning Notes
1	1	4252790/1	Snäckväxel kpl	Gear Case Assy R28	
2	1	2653460	Skruv	Screw	
3	1	3121170	Tätningring	Oil Seal	
4	2	2135050	Skruv	Screw	
5	1	2653090	Skruv	Screw	
6	2	2312150	Bricka	Washer	
7	2	2135060	Skruv	Screw	
8	1	2135030	Skruv	Screw	
9	1	3615000	Kniv	Line Cutter	
10	1	12154330/0	Mutter	Nut	
11	1	2312150	Bricka	Washer	
12	1	8563570	Stängskydd kpl	Safety Cover Ass.Y (Incl.40-43)	
13	1	3641700/1	Krage	Collar	
14	1	3641640	Ringmutter-övre	Upper Ring Nut	
15	1	3612640	Ringmutter-nedre	Lower Ring Nut	
16	1	4560610	Stabilisator kpl	Stabilizer	
21	1	4353000	Skärhuvud kpl Profi	2 Hedges Nylon Head Profi	
22	1	3614950	Platta	Plate	
23	1	4611880	Röjklinga	4 Teeth Disc 25 Cm	