

SLUTDREV KPL/FINAL GEAR ASSY

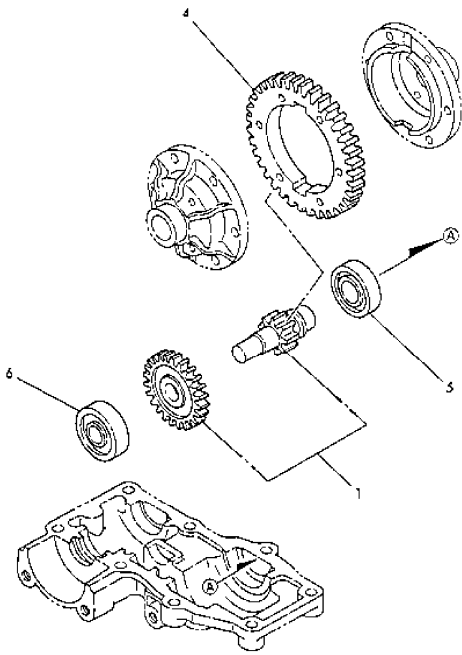

DRIVAXEL KPL/AXLE SHAFT ASSY

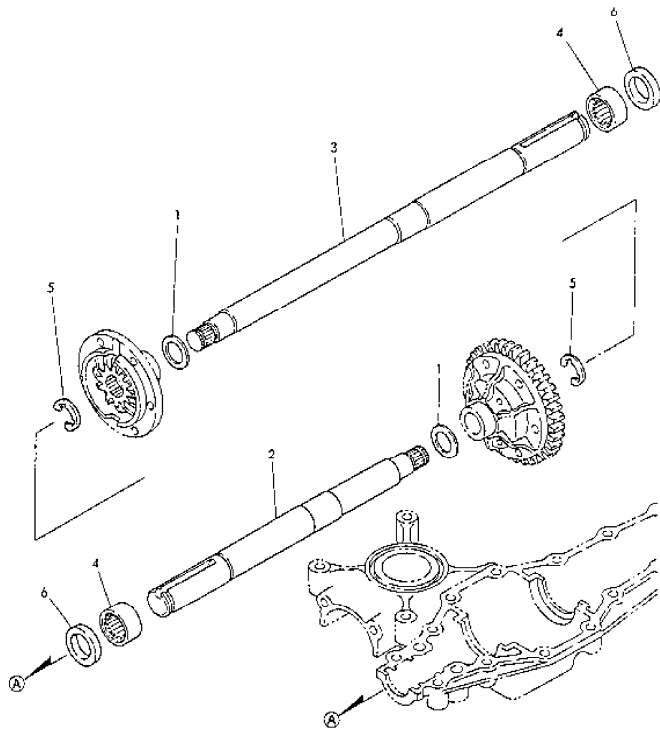

BROMS KPL/BRAKE ASSY

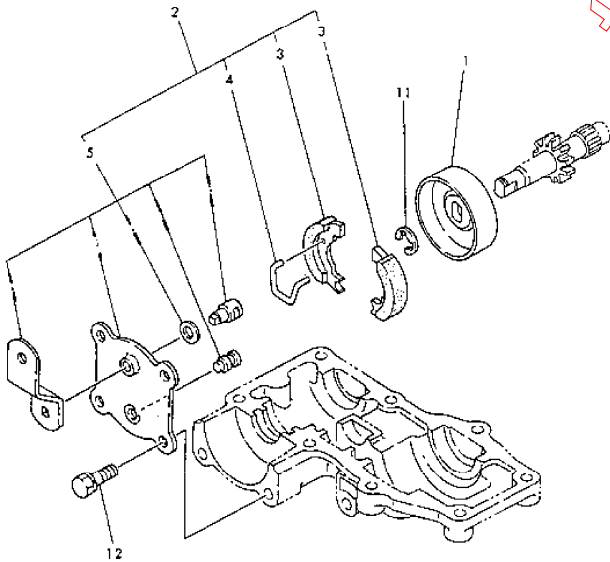

test

Section: KANZAKI TRANSAXLE K110

Pos.	Quantity	Spare part No	Description	Kit	Notes	New
K110						
1	1	1139-0213-01	Final pinion assy			
4	1	1139-0214-01	Final gear			
5	1	1139-0236-01	Ball bearing			
6	1	9549-0041-00	Ball bearing			
A1	2	1139-0225-01	Washer			
A2	1	1139-0215-01	Axle shaft-L.H.			
A3	1	1139-0216-01	Axle shaft-R.H.			
A4	2	1139-0217-01	Needle bearing			
A5	2	1139-0229-01	Ring			
A6	2	1139-0241-01	Seal			
B1	1	1139-0220-01	Brake drum			
B2	1	1139-0221-01	Brake assy			
B3	2	1139-0218-01	.Brake shoe			
B4	1	1139-0219-01	.Spring			
B5	1	1139-0222-01	.Brake cover assy			
B11	1	1139-0228-01	Ring			
B12	4	1139-0242-01	Bolt			

test

TRANSMISSIONSHUS KPL/TRANSAXLE CASE ASSY

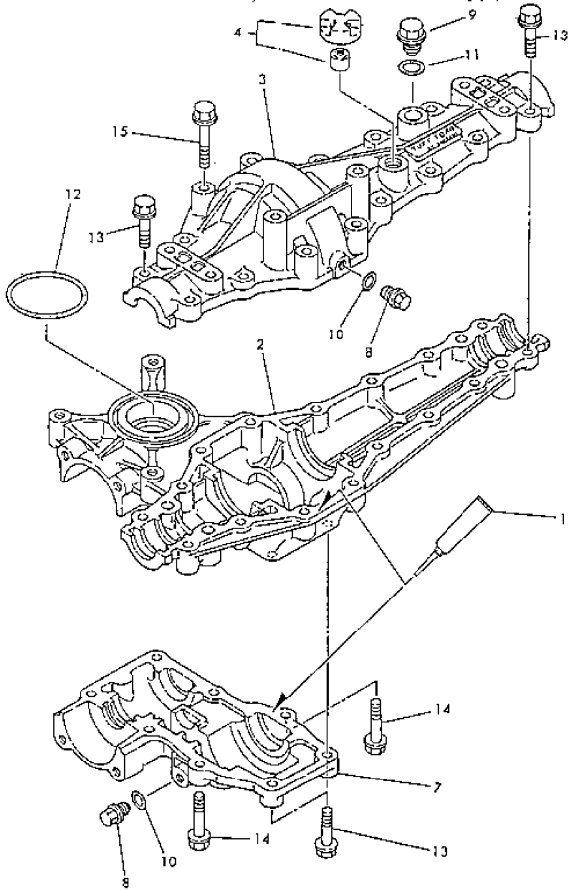

HUVUDAXEL KPL/MAIN SHAFT ASSY

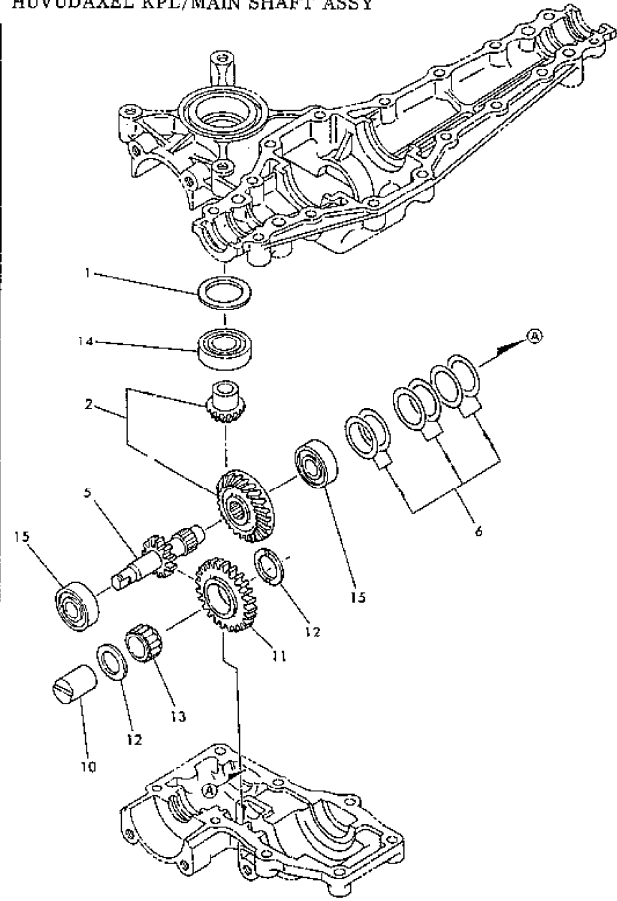

DIFFERENTIALDREV KPL/DIFFERENTIAL GEAR ASSY

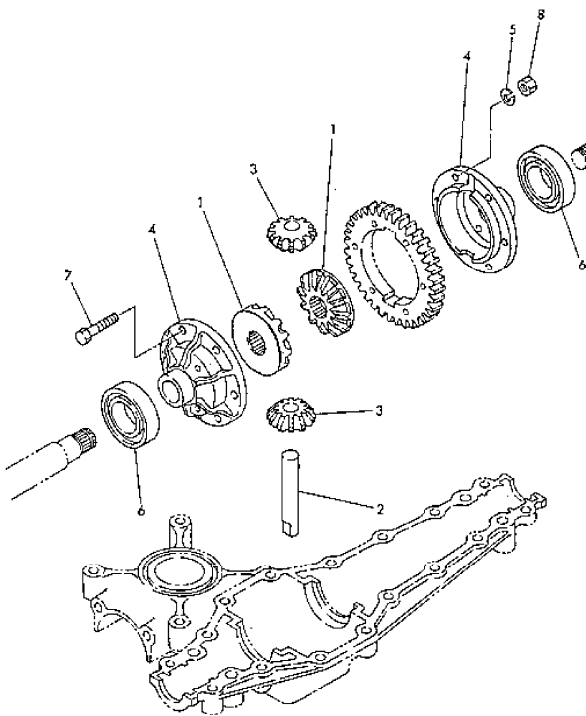

test

Section: KANZAKI TRANSAXLE K110

Pos.	Quantity	Spare part No	Description	Kit	Notes	New
K110						
1	1	1139-0223-01	Sealant			
2	1	1139-0200-01	Transmission case			
3	1	1139-0202-01	Upper case			
4	1	1139-0224-01	Vent valve assy			
7	1	1139-0203-01	Lower case			
8	2	1139-0231-01	Plug			
9	1	1139-0232-01	Plug			
10	2	1139-0238-01	Packing			
11	1	1139-0239-01	Packing			
12	1	1139-0240-01	Packing			
13	14	1139-0244-01	Tapping screw			
14	6	1139-0245-01	Tapping screw			
15	4	1139-0246-01	Tapping screw			
A01	1	1139-0201-01	Washer			
A02	1	1139-0204-01	Motor gear assy			
A05	1	1139-0205-01	Main shaft			
A06	1	1139-0206-01	Shim assy			
A10	1	1139-0207-01	Idle shaft			
A11	1	1139-0208-01	Gear (24)			
A12	2	1139-0209-01	Thrust			
A13	1	1139-0210-01	Needle bearing			
A14	1	1139-0233-01	Ball bearing			
A15	2	1139-0235-01	Ball bearing			
B01	2	1139-0226-01	Differential gear			
B02	1	1139-0211-01	Pinion shaft			
B03	2	1139-0227-01	Differential pinion			
B04	2	1139-0212-01	Case			
B05	6	1139-0230-01	Washer			
B06	2	1139-0234-01	Ball bearing			
B07	6	1139-0243-01	Bolt			
B08	6	1139-0247-01	Nut			