

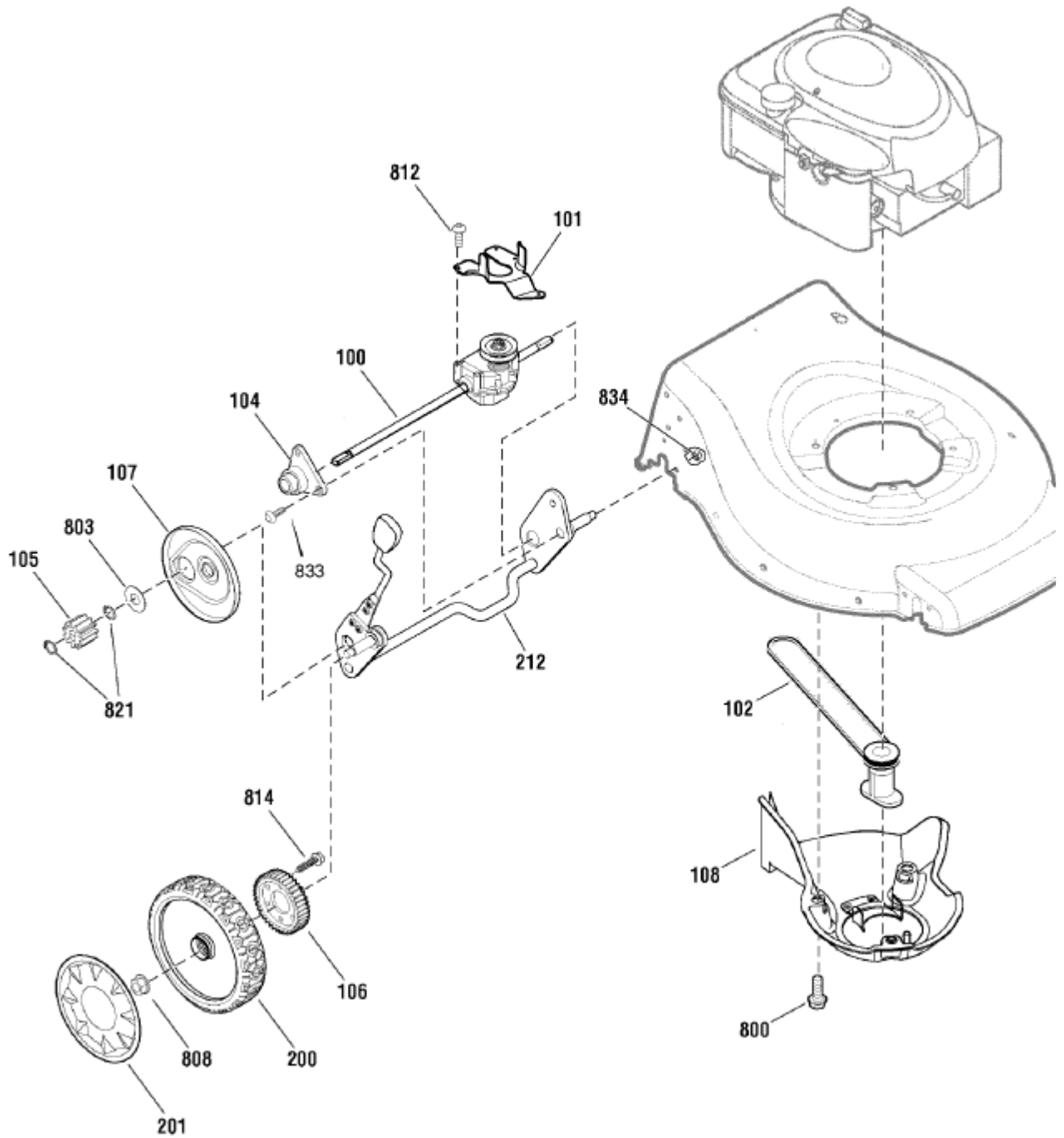











Supercessions	Ref #	Part #	<input checked="" type="checkbox"/> Description	<input checked="" type="checkbox"/> Qty	<input checked="" type="checkbox"/> Context Note	<input type="checkbox"/> Foot Note	<input type="checkbox"/> UOM
	1	10T602-0120-B1 Add to pick list	*ENGINE, 5TP, Briggs & Stratton	1	(Engine Model: 10T602-0120- B1) (Used on MX500 series)	NOTE: * Purchase engine parts from engine manufacturer dealer.	
	1	10T802-0161-B1 Add to pick list	*ENGINE, 5.5TP Briggs & Stratton	1	(Engine Model: 10T802-0161- B1) (Used on MX550 Series)	NOTE: * Purchase engine parts from engine manufacturer dealer.	
	2	881116BIYP Add to pick list	MOWER HOUSING	1	(Includes Ref. Nos. 300 & 302)		Ea
	3	880950AYP Add to pick list	BRACKET ASSEMBLY, Left Handle	1			Ea
	4	880951AYP Add to pick list	BRACKET ASSEMBLY, Right Handle	1			Ea
	6	880638YP Add to pick list	BLADE, 19 Inch	1			Ea
	7	880567YP Add to pick list	BLADE ADAPTER ASSEMBLY	1			Ea
	8	880671YP Add to pick list	DOOR, Rear	1			Ea
	9	880214YP Add to pick list	ROD, Rear Door	1			Ea
	10	880942YP Add to pick list	SPRING, Torsion Rear Door, Right	1			Ea
	11	880941BNYP Add to pick list	FRAME ASSEMBLY	1	(Red)		Ea
	11	880941ZYP Add to pick list	FRAME ASSEMBLY	1	(Black)		Ea
	12	880938YP Add to pick list	BAG ASSEMBLY	1			Ea
	13	880943YP Add to pick list	SPRING, Torsion Rear Door, Left	1			Ea
	50	881108YP Add to pick list	SIDE GUARD, Right	1			Ea
	51	881111YP Add to pick list	SIDE GUARD, Left	1			Ea
	200	880194YP Add to pick list	WHEEL, Rear	1			Ea
	201	880699YP Add to pick list	HUBCAP, Rear	1			Ea
	202	880703YP Add to pick list	WHEEL, Front	1			Ea
	203	880698YP Add to pick list	HUBCAP, Front	1			Ea
	206	880640YP Add to pick list	CROSSBAR ASSEMBLY, Front	1			Ea
	208	880050YP Add to pick list	BUSHING, Front Crossbar	1			Ea









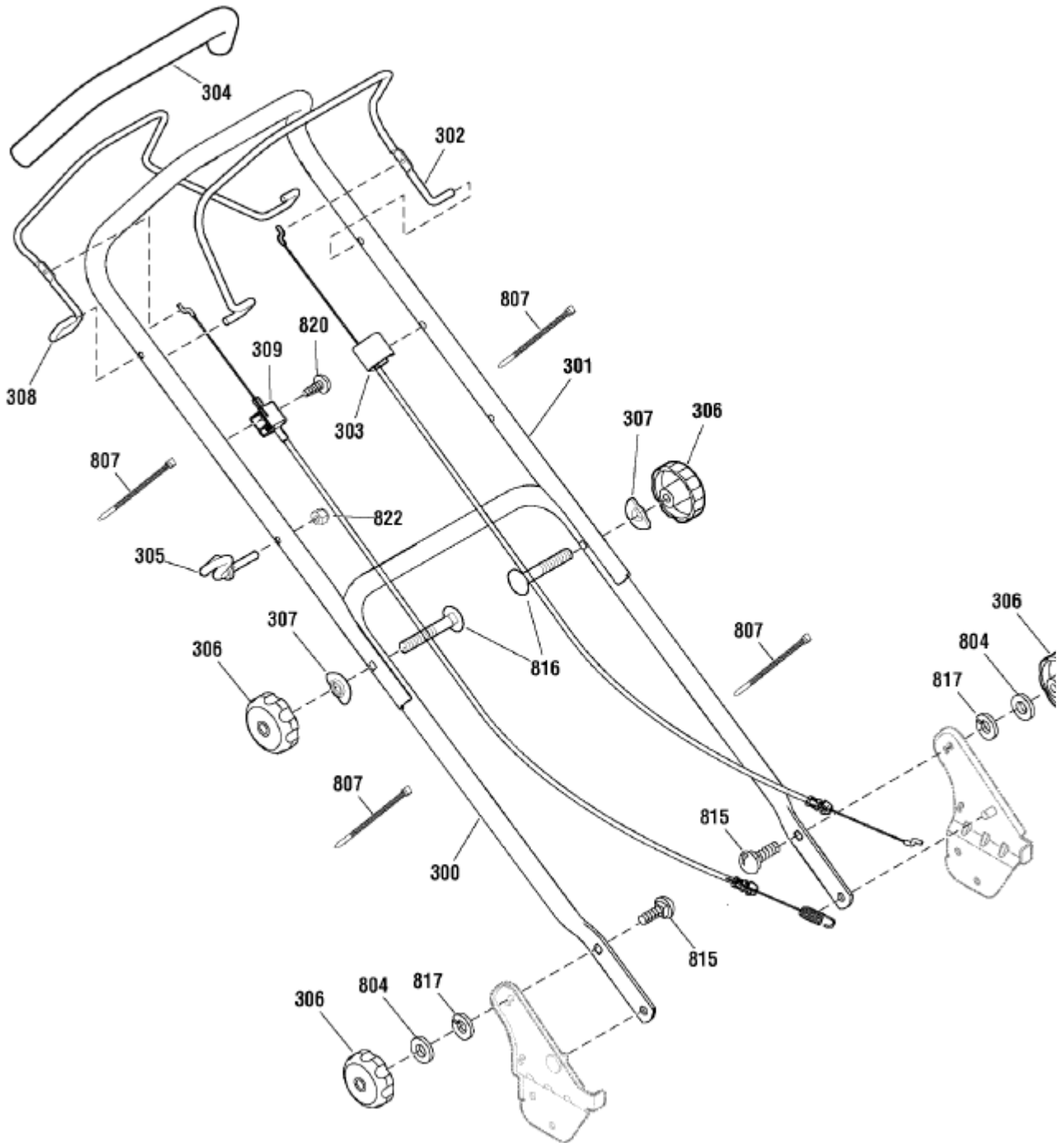

	209	881163YP Add to pick list	SPRING, Clip Crossbar	2			Ea
	210	880791BIYP Add to pick list	LINK, Single Lever	1			Ea
	211	880052YP Add to pick list	SPRING, Extension	1			Ea
	213	880829BIYP Add to pick list	CROSSBAR, Rear	1			
	214	880642YP Add to pick list	SPRING, Adjuster	1			Ea
	215	880540YP Add to pick list	LEVER, Height Adjustment	1			Ea
	216	881059YP Add to pick list	KNOB, Adjuster	1			Ea
	217	880960YP Add to pick list	BRACKET, Height Adjuster	1			Ea
	300	880784BIYP Add to pick list	BAFFLE, Front, 19	1			Ea
	301	880785YP Add to pick list	BAFFLE, Rear, 19	1			Ea
	302	880664YP Add to pick list	SCREW, Pan Head, Taptite, 1/4-20 x 1/2	5			Ea
	303	880804YP Add to pick list	SCREW, Pan Head, Taptite, 1/4-15 x 5/8	5			Ea
	304	795171YP Add to pick list	SHROUD/LABEL	1			Ea
	305	694046 Add to pick list	SCREW, Hex Washer Head	2			
	800	0025X6MA Add to pick list	SCREW, Hex Head, 3/8-16 x 1	1			Ea
	801	880034YP Add to pick list	BOLT, Blade, 3/8-24 x 2	1			Ea
	802	1101989MA Add to pick list	WASHER, Belleville	1			Ea
	805	880020YP Add to pick list	NUT, Nylock, M8 x 1-1/4	2			Ea
	808	015X84MA Add to pick list	NUT, Flange, 3/8-16	1			Ea
	810	880323YP Add to pick list	BOLT, Hex Key Head	2			Ea
	811	880428YP Add to pick list	NUT, Nylock	1			Ea
	813	880339YP Add to pick list	SCREW, Torx Head, M5 x .8 x 14mm	1			Ea
	818	7091020YP Add to pick list	PUSHNUT, 1/4	2			Ea
	819	880577YP Add to pick list	SCREW, Torx Head, M5 x .8 x 12.5mm	1			Ea
	823	880651YP Add to pick list	BOLT, Shoulder, 5/16-18 x 1	1			Ea
	824	015X88MA Add to pick list	Nut, Flange, 5/16-18	1			Ea

	830	48901MA Add to pick list	SCREW , 5/16- 18 x 3/4	1			Ea
	1000	700271YP Add to pick list	DECAL KIT	1			Ea



Supercessions	Ref #	Part #	<input checked="" type="checkbox"/> Description	<input checked="" type="checkbox"/> Qty	<input checked="" type="checkbox"/> Context Note	<input checked="" type="checkbox"/> Foot Note	<input checked="" type="checkbox"/> UOM
	100	880341YP Add to pick list	TRANSMISSION	1			Ea
	101	880282YP Add to pick list	BELT GUIDE, Transmission	1			Ea
	102	880268YP Add to pick list	V-BELT	1			Ea
	104	880787YP Add to pick list	SLEEVE ASSEMBLY, Rear Axle	1			Ea
	105	880226YP Add to pick list	GEAR, Pinion	1			Ea
	106	880225YP Add to pick list	GEAR, Drive	1			Ea
	107	880640YP Add to pick list	DUST COVER	1			Ea
	108	880796YP Add to pick list	BELT COVER ASSEMBLY	1			Ea
	200	880194YP Add to pick list	WHEEL, Rear	1			Ea
	201	880699YP Add to pick list	HUBCAP, Rear	1			Ea
	212	880829BIYP Add to pick list	CROSSBAR, Rear	1			
	800	0025X6MA Add to pick list	SCREW, Hex Head, 3/8-16 x 1	1			Ea
	803	880324YP Add to pick list	WASHER, Thrust	1			Ea
	808	015X84MA Add to pick list	NUT, Flange, 3/8-16	1			Ea
	812	880760YP Add to pick list	SCREW, #10 x 1	1			Ea
	814	26X296MA Add to pick list	SCREW, 1/4-15 x 3/4	1			Ea
	833	880845YP Add to pick list	SCREW, Torx, 1/4-20 x 5/8	1			Ea
	821	880269YP Add to pick list	RING, External Retaining	1			Ea
	834	880859YP Add to pick list	NUT, Flange Lock, 1/4-20	1			Ea



Supercessions	Ref #	Part #	<input checked="" type="checkbox"/> Description	<input checked="" type="checkbox"/> Qty	<input checked="" type="checkbox"/> Context Note	<input checked="" type="checkbox"/> Foot Note	<input checked="" type="checkbox"/> UOM
	300	880571AYP Add to pick list	HANDLE, Lower	1			Ea
	301	880210AYP Add to pick list	HANDLE, Upper	1			Ea
	302	880476BNYP Add to pick list	LEVER, Engine Stop	1	(Red)		Ea
	302	880476ZYP Add to pick list	LEVER, Engine Stop	1	(Black)		Ea
	303	880279YP Add to pick list	CABLE, Engine Stop	1			Ea
	304	880591YP Add to pick list	TUBING, Foam	1			Ea
	305	672510MA Add to pick list	GUIDE, Rope	1			Ea
	306	881056YP Add to pick list	KNOB, 5/16-18	1			Ea
	307	880615YP Add to pick list	WASHER, Formed	1			Ea
	308	881061BNYP Add to pick list	LEVER, Drive	1	(Red)		Ea
	308	881061ZYP Add to pick list	LEVER, Drive	1	(Black)		Ea
	309	880297YP Add to pick list	CABLE ASSEMBLY, Drive	1			Ea
	804	880607YP Add to pick list	WASHER, 5/8	1			Ea
	807	880029YP Add to pick list	CABLE TIE	1			Ea
	815	880576YP Add to pick list	BOLT, Carriage, 5/16- 18 x 1-1/8	1			Ea
	816	002X77MA Add to pick list	BOLT, Carriage, 5/16- 18 x 2	1			Ea
	817	22129GS Add to pick list	Washer, Lock	1			
	820	26X256MA Add to pick list	SCREW, Tap, #10 x 1- 1/4	1			Ea
	822	15X116MA Add to pick list	NUT, Hex, 1/4-20	1			Ea