

MODEL 38714x51B

REPAIR PARTS CHASSIS & HOOD

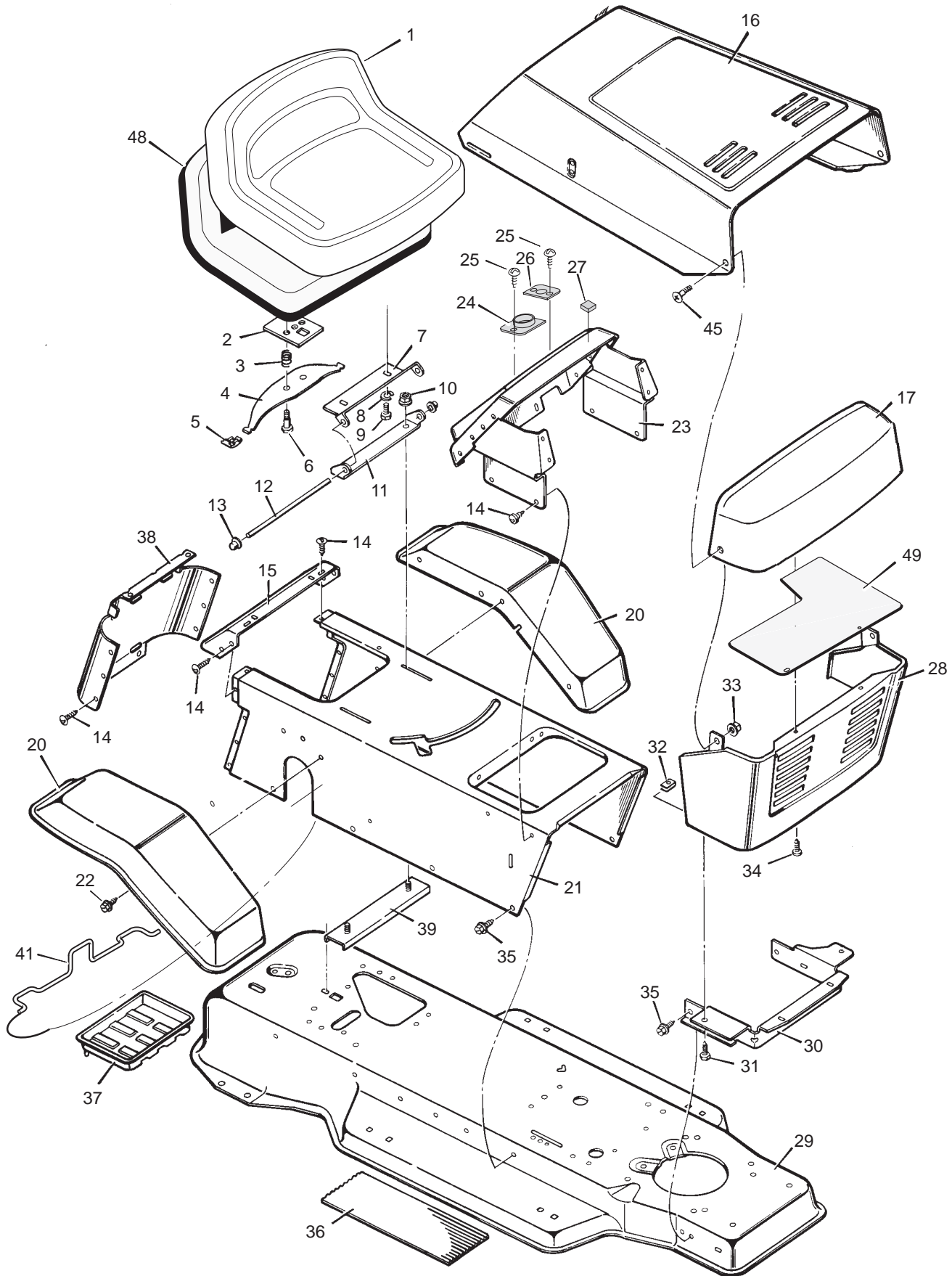

MODEL 38714x51B

REPAIR PARTS CHASSIS & HOOD

Key No.	Description	Part No.	Key No.	Description	Part No.
1	Seat	92387	25	Screw	26x238
2	Plate Assembly, Switch	91963Z	26	Bearing	93155
3	Spring, Compression	164x26	27	Bumper	92444
4	Spring, Seat	91964	28	Grill, Lower	91722E245
5	Glide, Spring	91822	29	Frame Assembly	92815E245
6	Bolt, Shoulder	9x38	30	Support, Grill	91723E700
7	Support, Seat	92334E700	31	Screw	26x252
8	Lockwasher	18x16	32	U–Nut	28x57
9	Bolt, Hex	1x45	33	Locknut, Flange	15x84
10	Locknut, Flange	15x88	34	Fastener, Plastic	193x1
11	Bracket, Pivot	91729E700	35	Screw	26x249
12	Rod, Pivot	91730 Z	36	Mat	94107
13	Cap, Push On	28x23	37	Tray, Battery	91895
14	Screw, Tap	26x270	38	Cap, Console *	92443E700
15	Fender, Apron *	91724E245	39	Channel Assembly	91857E700
16	Hood	91852E245	41	Clamp, Battery	92725E700
17	Grille, Upper	91736	45	Bolt, Shoulder	9x58
20	Fender	91715E245	48	Pan, Seat (with foam)	92357
21	Console Assembly	92727E245	49	Shield, Heat	94334
22	Screw	26x263	—	Instruction Book & Parts List	F–99790
23	Dash Panel	93174E245	—	Decal, Hood	44x7934
24	Bearing, Steering	93135	—	Decal, Top Console – Warning	44x6815

* Also included with Key No. 21.

MODEL 38714x51B

REPAIR PARTS MOTION DRIVE

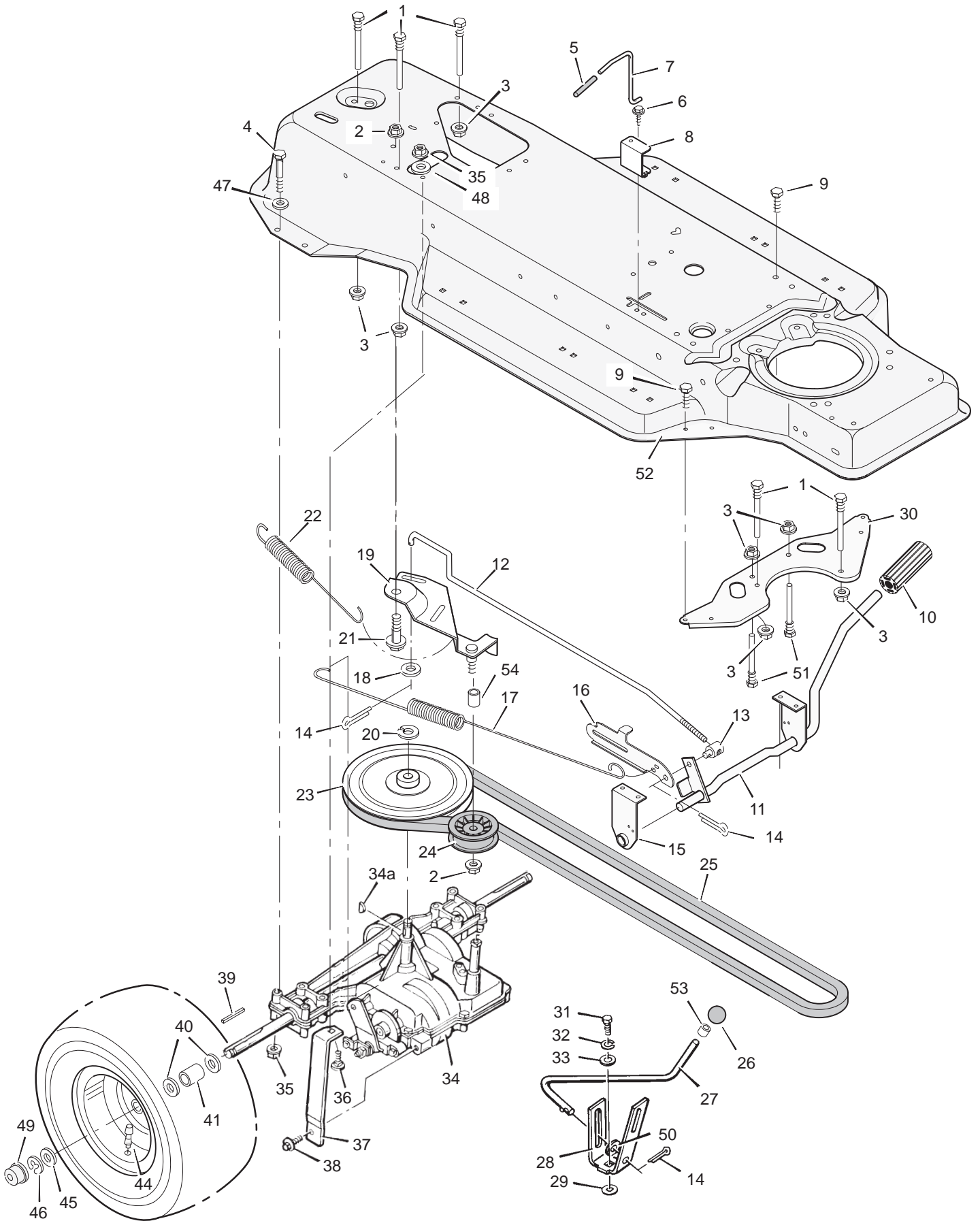

MODEL 38714x51B

REPAIR PARTS MOTION DRIVE

Key No.	Description	Part No.	Key No.	Description	Part No.
1	Guide, Belt	91754Z	29	Washer	17x148
2	Locknut, Flange	15x84	30	Plate, Belt Guide	92694E700
3	Nut, Flange	15x79Z	31	Bolt, Hex	1x145
4	Bolt, Hex	1x124	32	Lockwasher	18x32
5	Grip	91079	33	Washer	17x180
6	Screw	26x214	34	Transaxle – Peerless **	—
7	Rod, Control	91727E700	34a	Woodruff Key No. 9	20697
8	Guide, Bracket	91825E700	35	Nut, Flange	15x88
9	Screw	26x249	36	Bolt, Carriage	2x64
10	Clutch and Brake Pedal	21544	37	Support, Transaxle	91804E700
11	Lever Assembly	91862E700	38	Screw	26x216
12	Rod, Clutch	91808Z	39	Key, Square	21553
13	Nut, Adjustable	21920	40	Washer	17x160
14	Pin, Cotter	30x20	41	Spacer, Transaxle	87x100Z
15	Bracket, Support	91713E700	42	Tire*	91923
16	Latch, Park Brake	91712Z	—	Tube	407049
17	Spring, Brake Extension	165x82	43	Wheel & Tire Assembly	92288–601
18	Washer	17x47Z	44	Stem, Valve	24373
19	Bracket Assembly, Idler	92737Z	45	Washer	17x195
20	Ring, Retainer	11x7	46	E–Ring	11x3
21	Bolt, Shoulder	9x39	47	Washer	17x146Z
22	Spring, Drive Extension	165x76	48	Washer	17x45
23	Pulley, Motion Drive	95094	49	Hub Cap	94618
24	Pulley, Backside Idler	690409	50	Washer	17x102
25	Belt, Motion Drive	37x61	51	Guide, Belt	20619
26	Knob, Shift Lever	91995	52	Frame Assembly	92815E245
27	Lever, Shift	91805Z	53	Ring, Tolerance	92008
28	Yoke, Shift	91806Z	54	Spacer	690369

* When you order a tire, make sure to give the brand name of the tire so that the tread pattern on the tire will match.

** For information on Replacement Parts see the Central Parts Distributor in your area.

MODEL 38714x51B

REPAIR PARTS STEERING

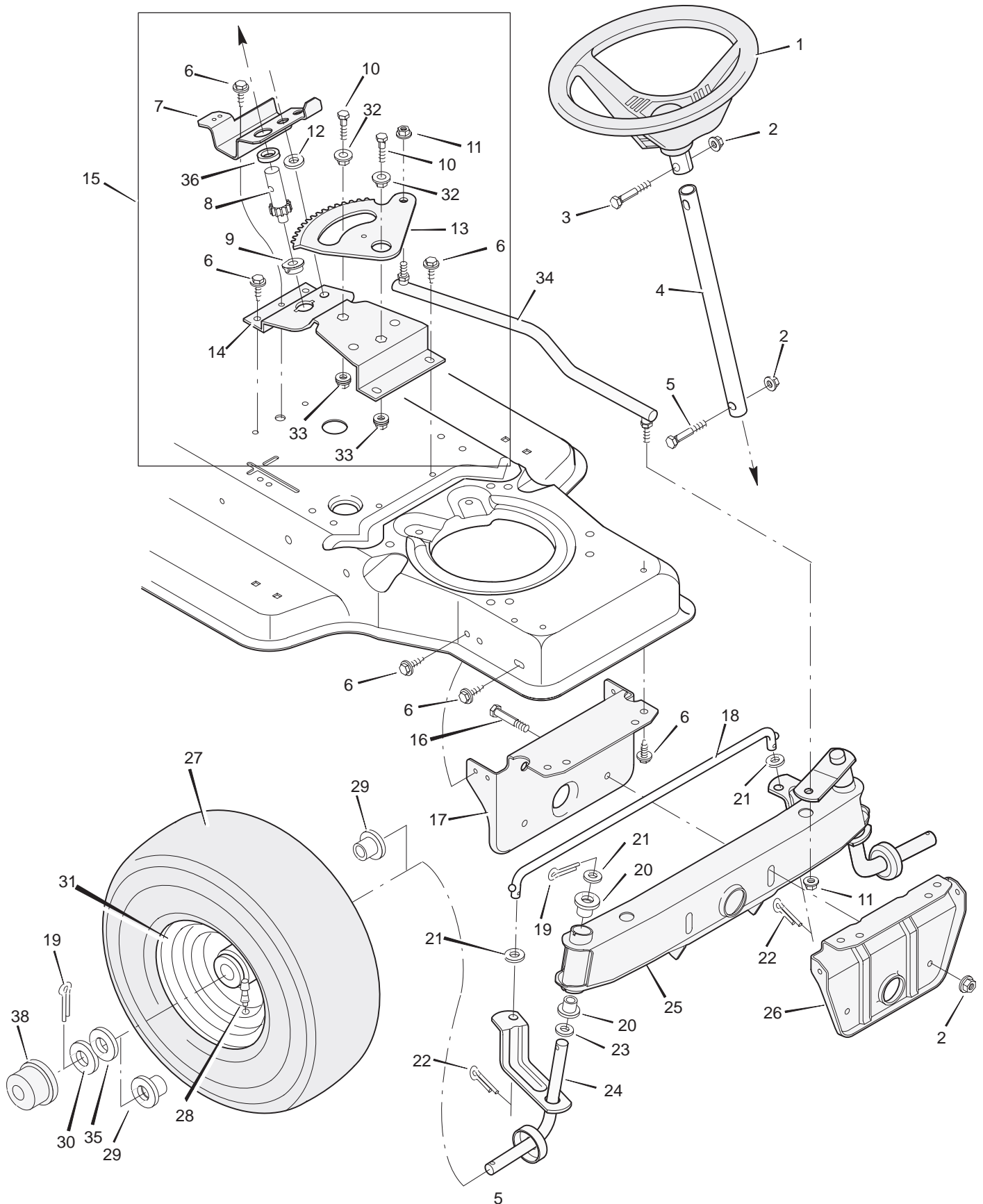

MODEL 38714x51B

REPAIR PARTS STEERING

Key No.	Description	Part No.
1	Wheel, Steering	92078
2	Nut, Hex	15x118
3	Bolt, Hex	1x66
4	Post, Steering	91714 Z
5	Bolt, Hex	1x74
6	Screw	26x249
7	Bracket, Sector	91716E700
8	Gear, Pinion	92715
9	Bearing	92716
10	Bolt, Hex	1x84
11	Locknut, Flange	15x87
12	Spacer	92564
13	Gear, Sector	92316
14	Bracket, Sector	91708E700
15	Kit, Steering Gear	402075
16	Bolt, Hex	1x146
17	Support, Rear Axle	92529E700
18	Rod, Tie	90038E700
19	Pin, Cotter	30x49
20	Bearing	92527
21	Washer	17x57
22	Pin, Cotter	30x20
23	Washer	17x113
24	Spindle Assembly, Right	91828E700
25	Spindle Assembly, Axle & Left	92518E700
26	Support, Front Axle	92528E700
27	Tire*	91912
—	Tube	407047
28	Stem, Valve	24373
29	Bearing, Wheel	91334
30	Washer	17x195
31	Wheel & Tire Assembly	94578-601
32	Bearing	92097
33	Locknut, Flange	15x113
34	Link, Drag	91749E700
35	Washer	17x192
36	Spacer, Pinion Gear	92280
38	Hub Cap (Optional)	94618

* When you order a tire, make sure to give the brand name of the tire so that the tread pattern on the tire will match.

MODEL 38714x51B

REPAIR PARTS MOWER HOUSING SUSPENSION

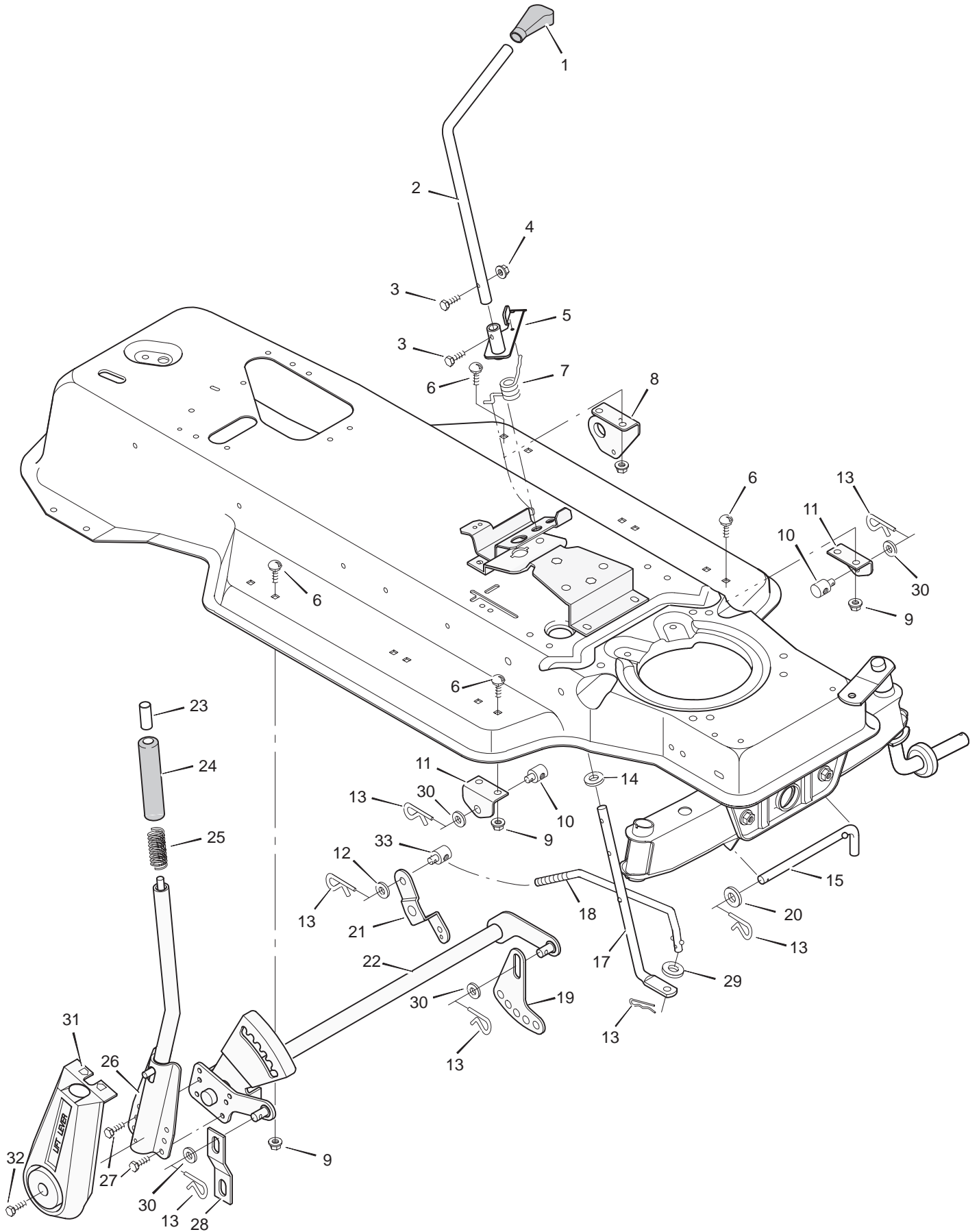

MODEL 38714x51B

REPAIR PARTS MOWER HOUSING SUSPENSION

Key No.	Description	Part No.
1	Grip	92698
2	Control, Blade Rotation	91781Z
3	Bolt, Hex	25x3
4	Locknut, Hex	15x67
5	Lever Assembly, Switch	91917E700
6	Bolt, Carriage	2x53
7	Spring, Torsion	166x32
8	Bracket, Rear Hanger	92066E700
9	Nut, Flange	15x79
10	Nut, Adjusting	92131
11	Bracket, Adjuster Rod	92133E700
12	Washer	17x124
13	Pin, Hair	31x4
14	Washer	17x122
15	Pin, Pull	90827Z
17	Lever, Lower Blade Control	91787E700
18	Rod, Blade Control	91795Z
19	Plate, Adjuster	91741E700
20	Washer	17x103
21	Bracket, Pivot	92033E700
22	Lifter Assembly	92065E700
23	Button, Push	92572
24	Grip	92783
25	Spring, Compression	164x21
26	Handle Assembly	91823E700
27	Screw	26x49
28	Link, Suspension	92064E700
29	Washer	17x47Z
30	Washer	17x91Z
31	Cover, Lift Lever (Optional)	92157
32	Screw	26x263
33	Nut, Adjusting	21920

MODEL 38714x51B

REPAIR PARTS MOWER HOUSING

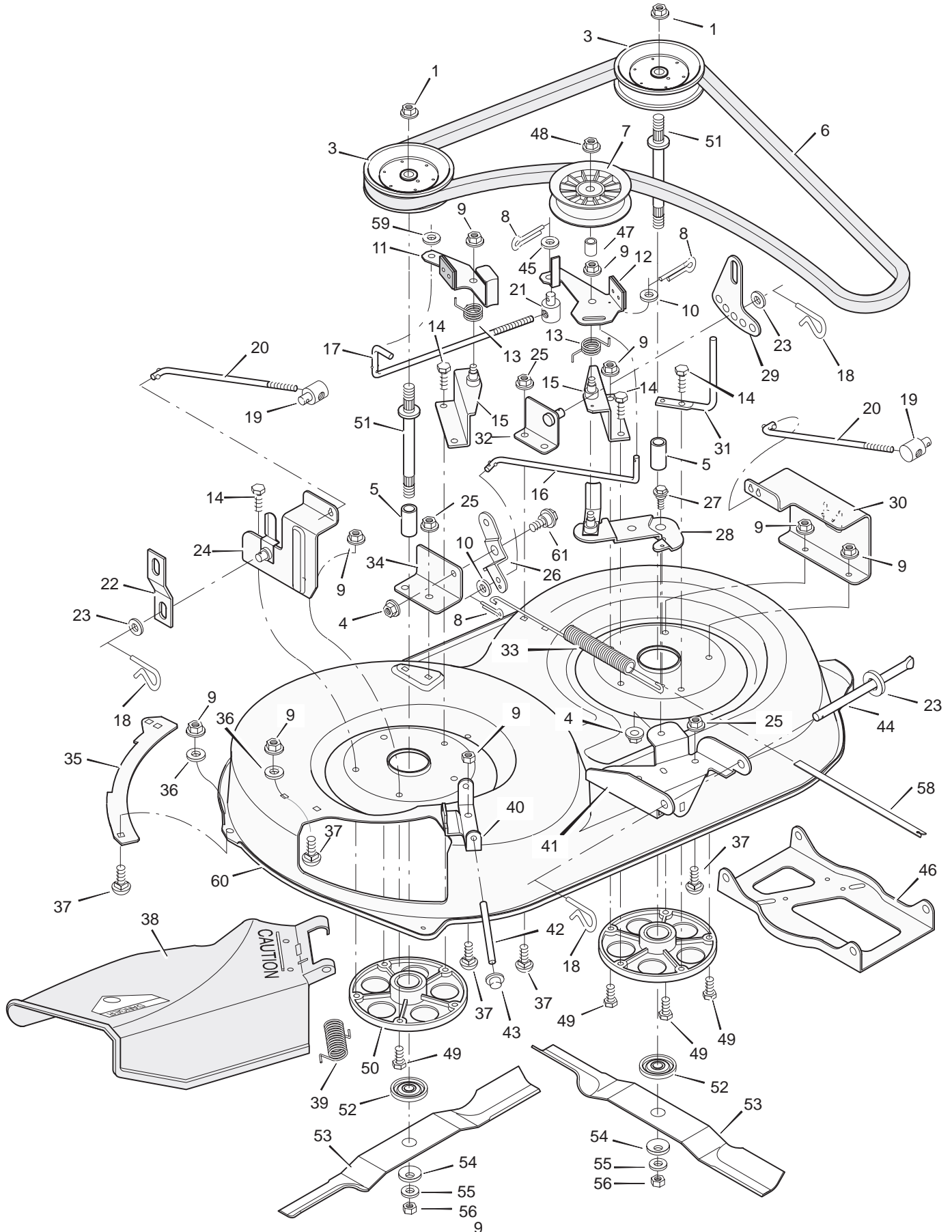

MODEL 38714x51B

REPAIR PARTS MOWER HOUSING

Key No.	Description	Part No.	Key No.	Description	Part No.
1	Nut, Hex	15x121	32	Bracket Assembly, Left Lifter	91813E700
3	Pulley, Jackshaft	92852	33	Spring, Extension	165x72
4	Locknut, Flange	15x84	34	Bracket, Pivot	91743E700
5	Spacer	92850	35	Plate	91770E700
6	Belt, Blade Drive	37x63	36	Washer	17x57
7	Pulley, Idler	690387	37	Bolt, Carriage	2x53
8	Pin, Cotter	30x20	38	Deflector Assembly, Chute	94707
9	Locknut, Flange	15x88	39	Spring, Torsion	166x4
10	Washer	17x46Z	40	Bracket, Hinge	94956E700
11	Brake Assembly, Right	92186E700	41	Bracket, Front Hanger	91793E700
12	Brake Assembly, Left	92187E700	42	Rod, Deflector	94957Z
13	Spring, Torsion	166x27	43	Cap, Push On	28x23
14	Bolt, Hex	25x7	44	Rod, Hanger	91739Z
15	Bracket Assembly, Brake	92072E700	45	Washer	17x124
16	Rod, Brake	91745Z	46	Hanger, Front	92119E700
17	Rod, Cross Link	92183Z	47	Spacer	690369
18	Pin, Hair	31x4	48	Nut, Flange	15x98
19	Nut, Adjustable	92131	49	Bolt, Hex	1x84
20	Rod, Adjuster	91748Z	50	Housing, Jackshaft	90905
21	Nut, Adjustable	21920	51	Jackshaft	92849
22	Link, Suspension	92064E700	52	Adapter, Blade	92466
23	Washer	17x103	53	Blade, 38" (2 required)	94913E701
24	Bracket Assembly, Right Lifter	92485E700	54	Washer, Belleville	17x166
25	Nut, Flange	15x79	55	Washer	17x165
26	Bracket, Pivot	92033E700	56	Nut, Hex	15x100
27	Bolt, Shoulder	9x39	58	Indicator, Plastic	92163
28	Arm Assembly, Idler	92032E700	59	Washer	17x48
29	Plate, Adjuster	91741E700	60	Housing, Blade (38")	91906E700
30	Cover, Pulley	92083E700	61	Bolt, Shoulder	9x42
31	Guide, Belt	91797E700	1-61	Complete Mower Housing Assembly	403228

MODEL 38714x51B

REPAIR PARTS ENGINE MOUNT

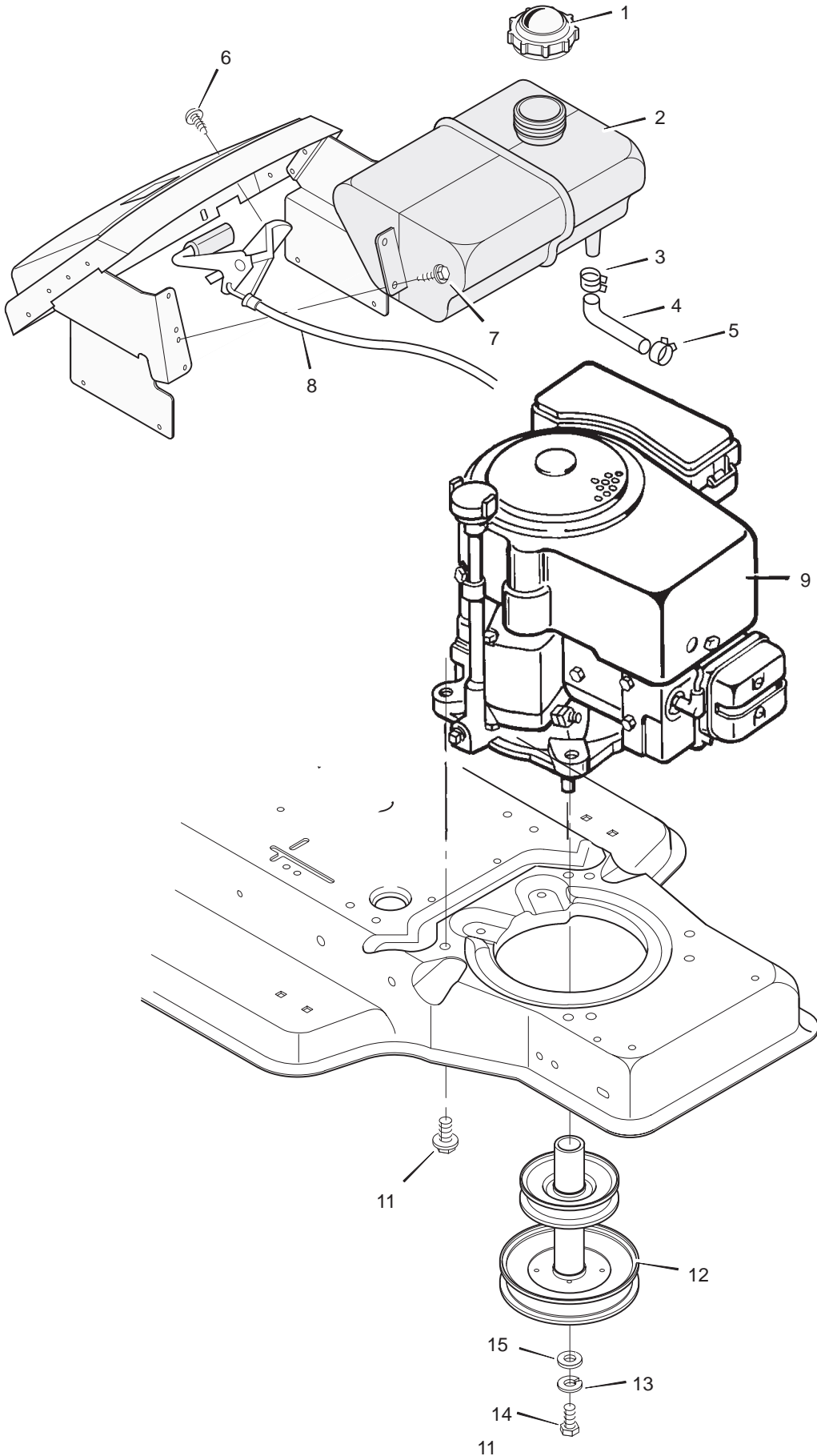

Key No.	Description	Part No.
1	Fuel Cap	92317
2	Fuel Tank	91869
3	Hose Clamp	95197
4	Fuel Line	23715
5	Hose Clamp	95197
6	Screw	26x201
7	Screw	26x201
8	Throttle Control	91983
9	Engine*	—
11	Bolt, Engine Mount	25x7
12	Stack Pulley Assembly	92318 Z
13	Lockwasher	19x35
14	Bolt, Hex	1x140
15	Washer	17x170

* Parts are available from an Authorized Service Center. See "Engines, Gasoline" or "Gasoline Engines" in the yellow pages of the telephone directory.

MODEL 38714x51B

REPAIR PARTS ELECTRICAL SYSTEM

POS.	FUNCTION	CIRCUIT (MAKE)
1	OFF	M+G
2	RUN	B+L
3	START	B+S

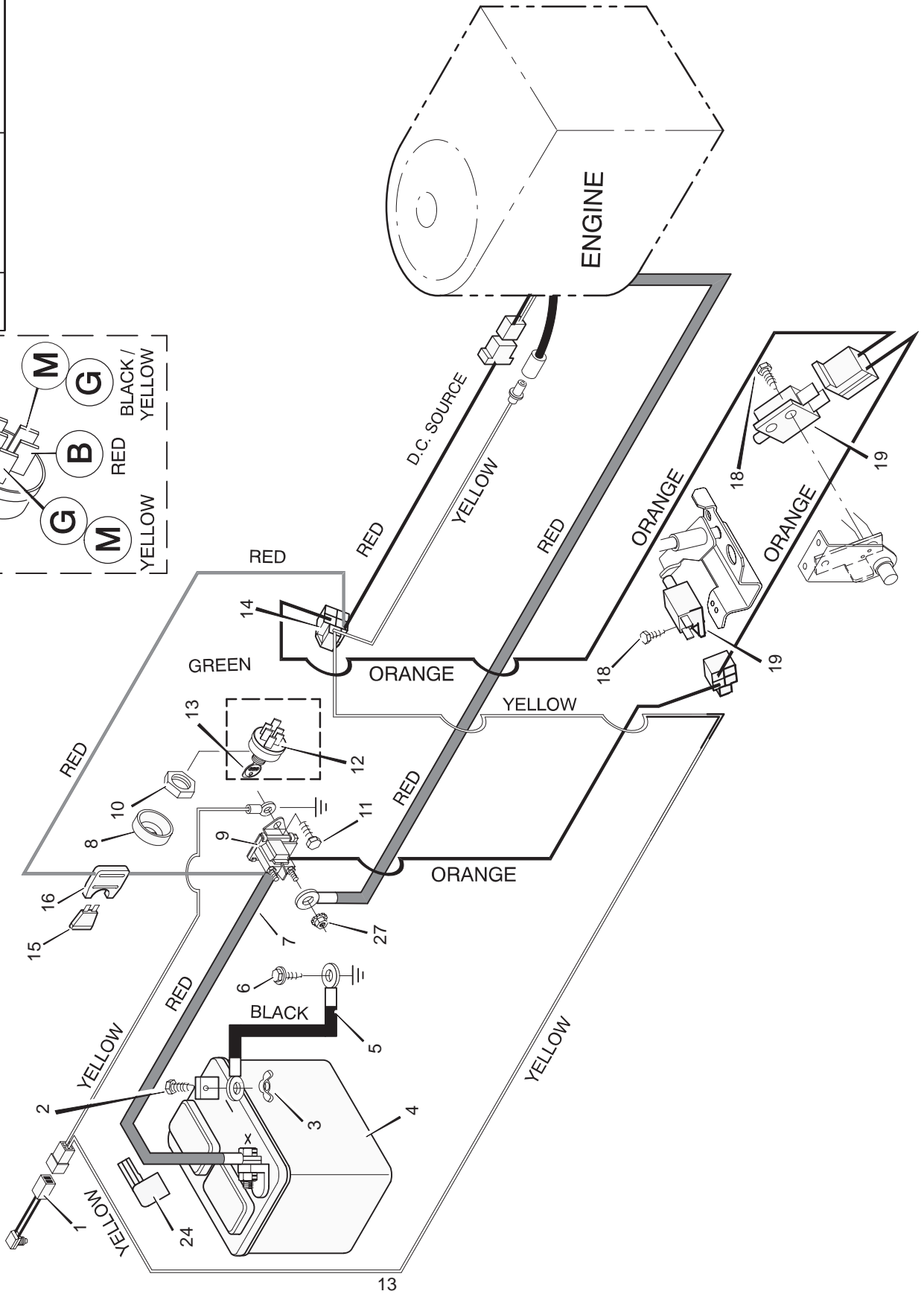
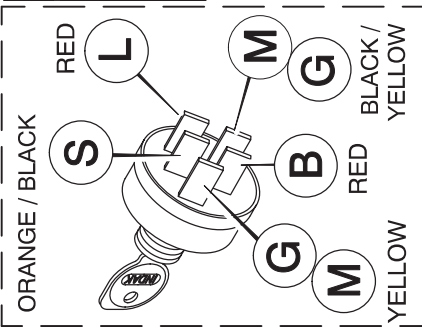

Key No.	Description	Part No.
1	Switch, Seat Sensor	91031
2	Bolt	2x82
3	Wingnut	14x79
4	Battery	91414
5	Cable, Battery Ground	24x30
6	Screw	26x249
7	Cable, Red Battery	24x29
8	Cap, Ignition	91488
9	Solenoid	24285
10	Nut	91489
11	Screw	26x214
12	Switch, Ignition	21064
13	Key, Ignition	20729
14	Harness, Chassis Wire	250x88
15	Fuse	54212
16	Holder, Fuse	407078
18	Screw	26x233
19	Switch, Clutch	24273
24	Cover, Terminal	54148
27	Locknut	15x116