

# MODEL 21666x19B

## Handle For Briggs Engine

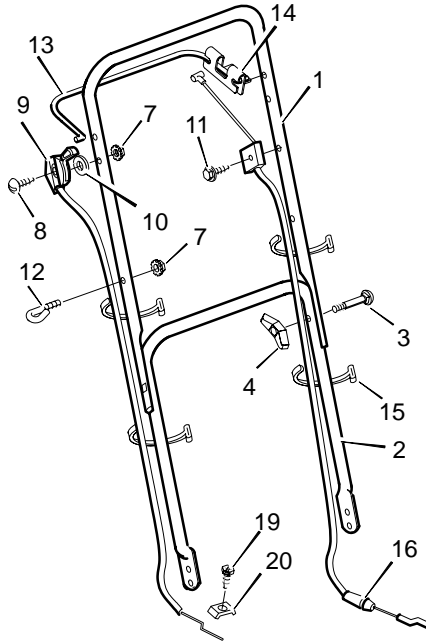

KEY NO.	DESCRIPTION	PART NO.	KEY NO.	DESCRIPTION	PART NO.
1	Handle, Upper (Black)	71581E701	10	Washer	17x184
--	Handle, Upper (Gray)	71581E724	11	Screw	26x220
2	Handle, Lower (Black)	71137E701	12	Guide, Rope	43956
--	Handle, Lower (Gray)	71137E724	13	Engine Stop Lever	43653E700
3	Bolt	2x77	14	Bracket, Stop Lever	43628 BC
4	Knob, Plastic	71294	15	Fastener, Cable	71372
7	Locknut	15x116	16	Engine Stop Cable	71563
8	Screw	3x144	19	Screw	26x268
9	Throttle Control	71559	20	Clamp	42294

# MODEL 21666x19B

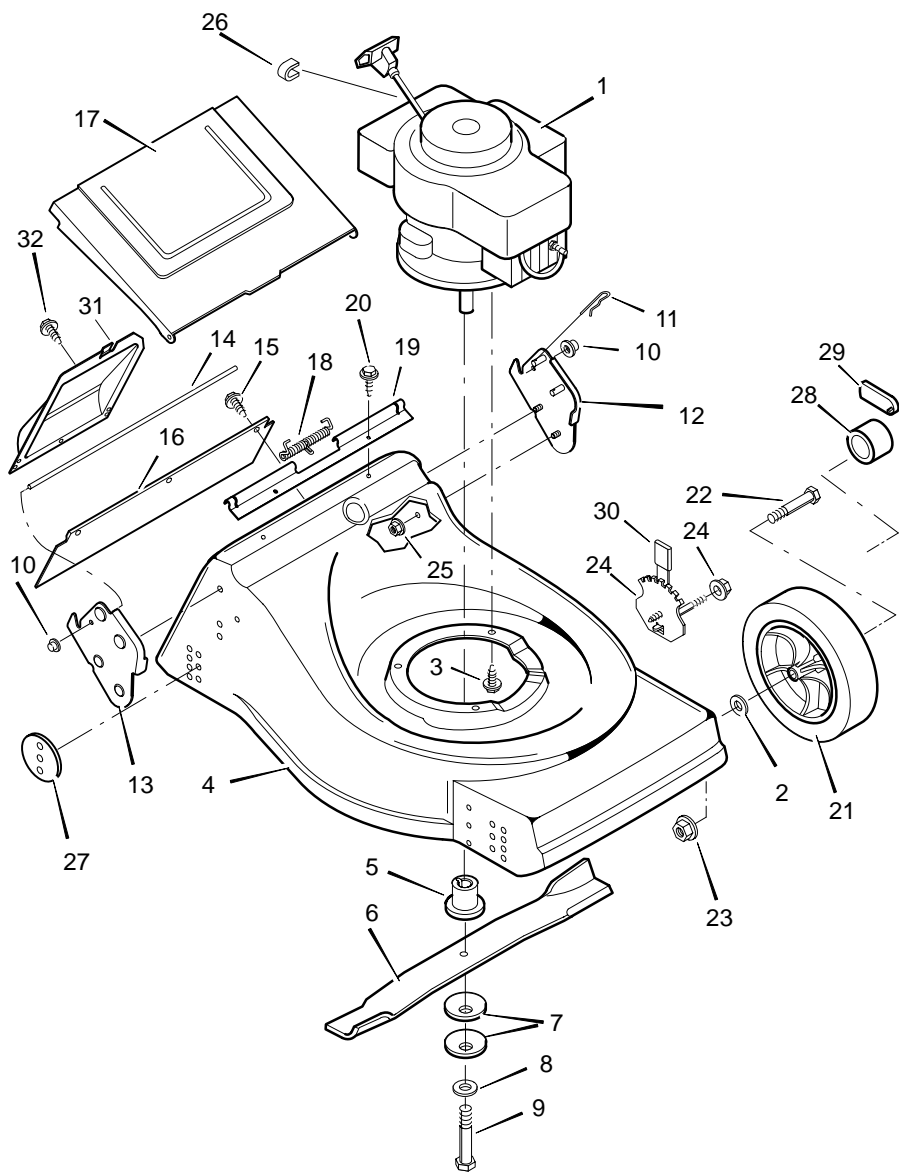

# MODEL 21666x19B

KEY NO.	DESCRIPTION	PART NO.
1	Engine ‡	_____
2	Washer	10851Z
3	Bolt, Engine	25x6
4	Housing	70162
5	Adapter, Blade	71056
6	Blade	71877E701
7	Washer, Belleville	17x137
8	Washer	17x124
9	Bolt, Hex	1x142
10	Push-On Cap	28x42
11	Pin, Hair	31x10
12	Bracket, Left Handle	71097E701
13	Bracket, Right Handle	71096E701
14	Rod, Door Pivot	215x14 Z
15	Screw	26x245
16	Deflector, Rear (Model with Height Adjusters)	43640
	Deflector, Rear (Model without Height Adjusters)	42678
17	Door, Rear	71517
18	Spring, Torsion	166x33
19	Spacer, Door	71410
20	Screw	26x259
21	Wheel and Tire #	_____
22	Bolt, Axle	9x10
23	Nut, Flange	15x68Z
24	Adjuster, Height	401025
25	Nut, Flange	15x79
26	Stop, Rope	42189
27	Spacer	43784
28	Hub Cap – Optional	20107
29	Hub Cap – Optional (For 8x2 in. Ball Bearing Wheel)	43847
—	Hub Cap – Optional (For 8x2 in. Plastic Wheel)	43615
30	Grip	43394
31	Cover, Rear	71246E701
32	Screw	26x214
–	Book, Instruction	F–96517

‡ Parts are available from a Authorized Engine Service Center. See “Engines, Gasoline” or “Gasoline Engines” in the yellow pages of the telephone directory.

# See the “Wheel And Tire Parts List” page.

# MODEL 21666x19B

LOOK AT THE ILLUSTRATIONS. SELECT THE WHEEL AND TIRE YOU WANT AND ORDER FROM THE FOLLOWING CHART.

**A**

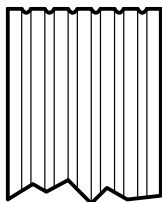
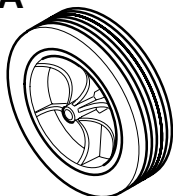

**E**

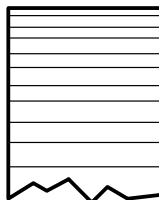
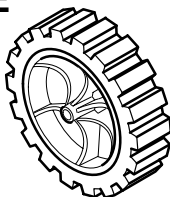

**B**

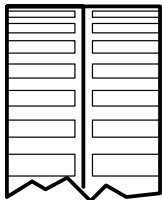

**F**

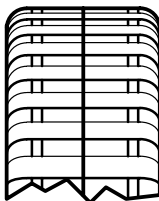

**C**

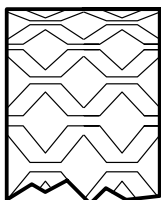
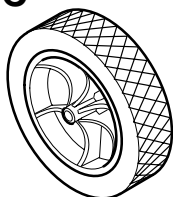

**G**

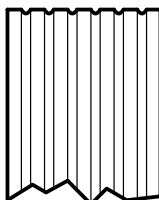
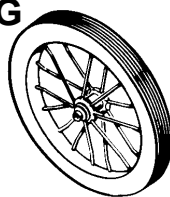

**D**

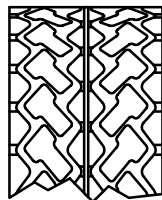
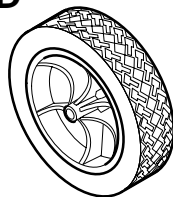

**H**

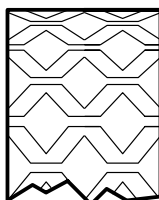
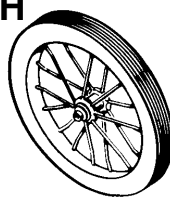

WHEEL SIZE & TYPE	A	B	C	D	E	F	G	H
6-inch Plastic, White	---	---	42174	---	---	---	---	---
7-inch Plastic, White	---	71148	20270	42172	---	---	---	---
7-inch Plastic, Gray	---	71596	71597	---	---	---	---	---
8-inch Plastic, White	20104	---	20271	42173	20105	43618	---	---
8-inch Plastic, Gray	71598	---	---	71599	71600	71132	---	---
8-inch Metal, White	43273	---	43414	---	43274	---	---	---
8-inch Ball Bearings, White	---	---	---	---	---	43724	---	---
8-inch Ball Bearings, Gray	---	---	---	---	---	71134	---	---
14-inch Spoke	---	---	---	---	---	---	42666	---
16-inch Spoke	---	---	---	---	---	---	70106	70119

# MODEL 21666x19B

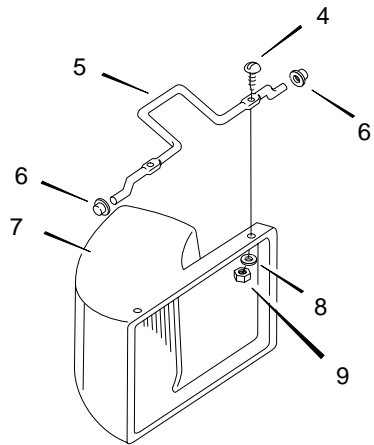
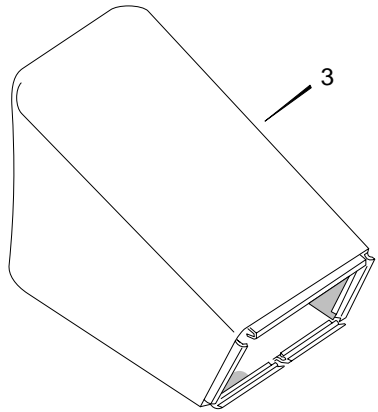
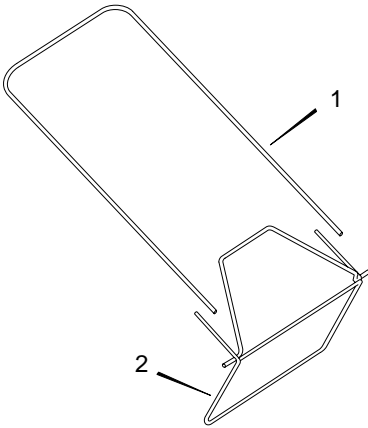

KEY NO.	DESCRIPTION	PART NO.
1	Support, Bag	71592
2	Frame Assembly	43666
3	Bag, Cloth	71589
4	Screw	4x21
5	Frame Assembly	43755Z
6	Push On Cap	28x39
7	Side Discharge Attachment – Optional +	43754
8	Washer	17x173
9	Nut	15x102

+ Model 24072A Side Discharge Attachment. This optional accessory gives you the option of discharging the grass to the side.