

MODEL 20255x19C

Handle For Briggs Engine

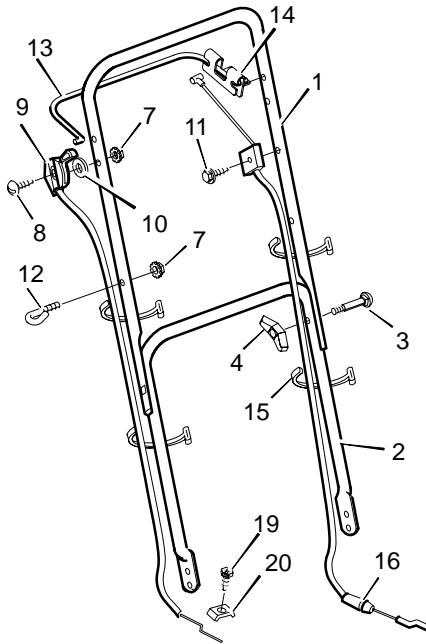

KEY NO.	DESCRIPTION	PART NO.	KEY NO.	DESCRIPTION	PART NO.
1	Handle, Upper - Straight (Black)	43838E701	10	Washer	17x188
--	Handle, Upper - Straight (Gray)	43838E724	11	Screw	26x220
2	Handle, Lower (Black)	71151E701	12	Guide, Rope	43956
--	Handle, Lower (Gray)	71151E724	13	Engine Stop Lever - Straight	43793
3	Bolt	2x77	14	Bracket, Stop Lever	43628 BC
4	Knob, Plastic	71294	15	Fastener, Cable	71372
7	Locknut	15x116	16	Engine Stop Cable	43825
8	Screw	3x144	19	Screw	26x268
9	Throttle Control	71180	20	Clamp	42294

MODEL 20255x19C

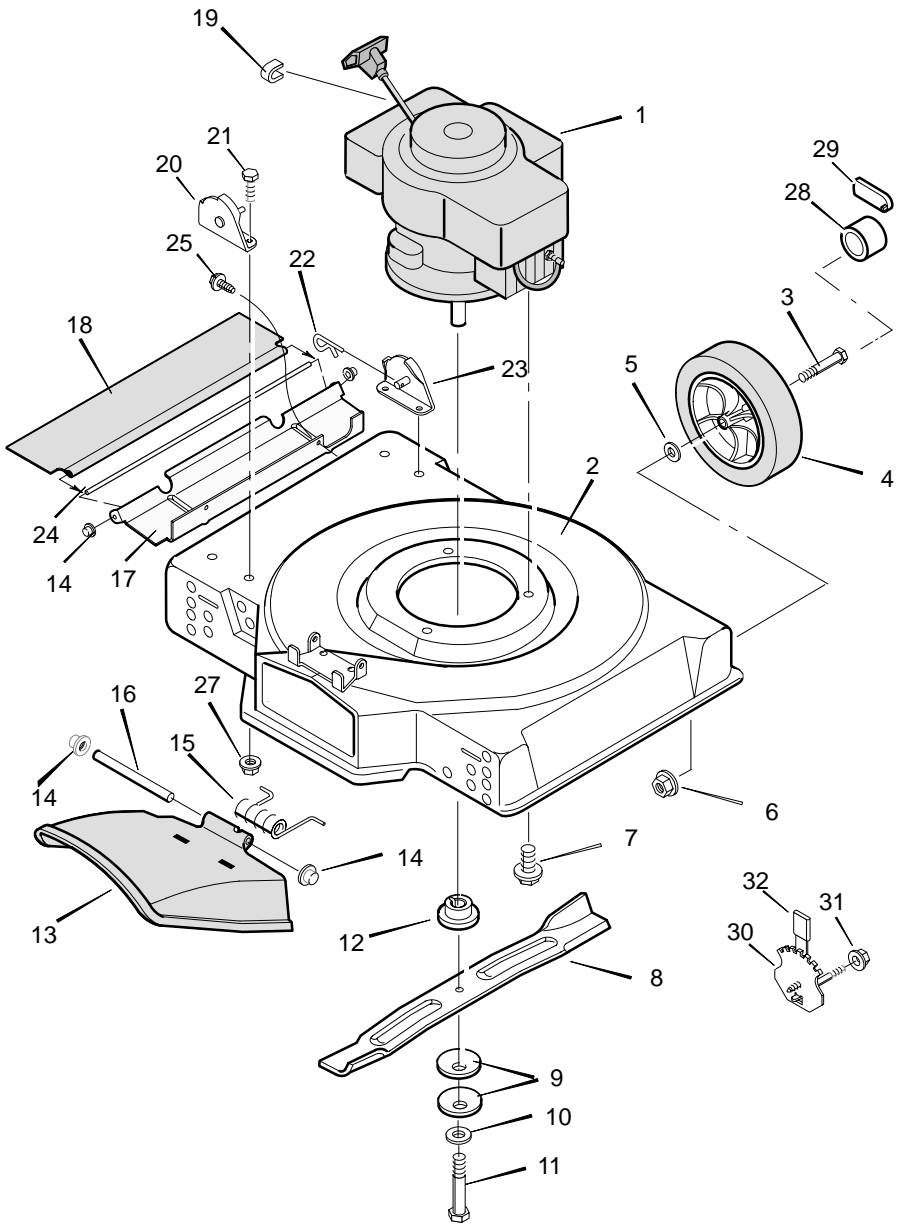

MODEL 20255x19C

KEY NO.	DESCRIPTION	PART NO.
1	Engine ‡	_____
2	Housing	70123A
3	Bolt, Axle	9x10
4	Wheel and Tire #	_____
5	Washer	10851 Z
6	Locknut, Flange	15x68
7	Bolt, Engine	25x6
8	Blade	42785E701
9	Washer, Belleville	17x137
10	Washer	17x124
11	Bolt, Hex	1x142
12	Adapter, Blade	71056
13	Deflector, Chute	42919
14	Push-On Cap	28x42
15	Spring	166x5
16	Pin, Pivot	215x11 Z
17	Extension, Rear	71746E701
18	Deflector, Rear	71797
19	Stop, Rope	42189
20	Bracket, Right Handle	42712E701
21	Bolt	1x38
22	Pin, Hair	31x10
23	Bracket, Left Handle	42713E701
24	Pin	71800Z
25	Screw	26x274
27	Nut	15x82
28	Hub Cap – Optional	20107
29	Hub Cap – Optional (For 8x2 in. Ball Bearing Wheel)	43847
—	Hub Cap – Optional (For 8x2 in. Plastic Wheel)	43615
30	Adjuster, Height	401025
31	Locknut, Flange	15x84
32	Grip	43394
–	Book, Instruction	F-96491

- ‡ Parts are available from a Authorized Engine Service Center. See “Engines, Gasoline” or “Gasoline Engines” in the yellow pages of the telephone directory.
- # See the “Wheel And Tire Parts List” page.

MODEL 20255x19C

LOOK AT THE ILLUSTRATIONS. SELECT THE WHEEL AND TIRE YOU WANT AND ORDER FROM THE FOLLOWING CHART.

A

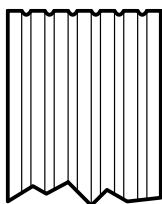
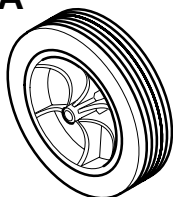

E

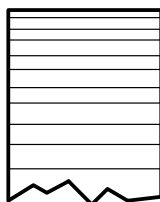
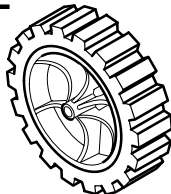

B

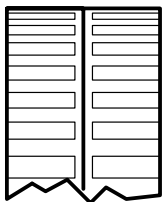

F

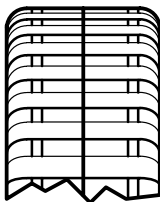
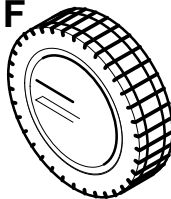

C

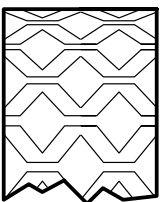
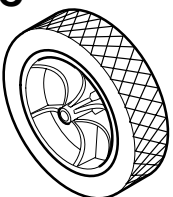

G

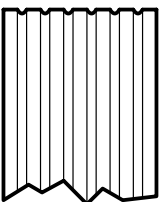
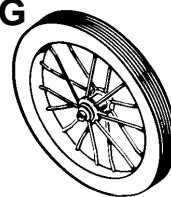

D

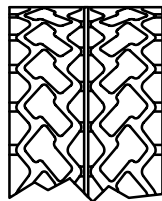
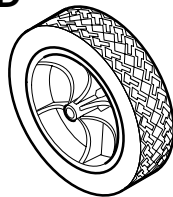

H

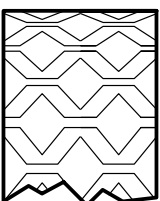
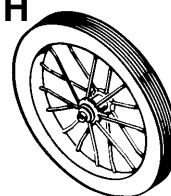

WHEEL SIZE & TYPE	A	B	C	D	E	F	G	H
6-inch Plastic, White	---	---	42174	---	---	---	---	---
7-inch Plastic, White	---	71148	20270	42172	---	---	---	---
7-inch Plastic, Gray	---	71596	71597	---	---	---	---	---
8-inch Plastic, White	20104	---	20271	42173	20105	43618	---	---
8-inch Plastic, Gray	71598	---	---	71599	71600	71132	---	---
8-inch Metal, White	43273	---	43414	---	43274	---	---	---
8-inch Ball Bearings, White	---	---	---	---	---	43724	---	---
8-inch Ball Bearings, Gray	---	---	---	---	---	71134	---	---
14-inch Spoke	---	---	---	---	---	---	42666	---
16-inch Spoke	---	---	---	---	---	---	70106	70119