

MODEL 20223x19A

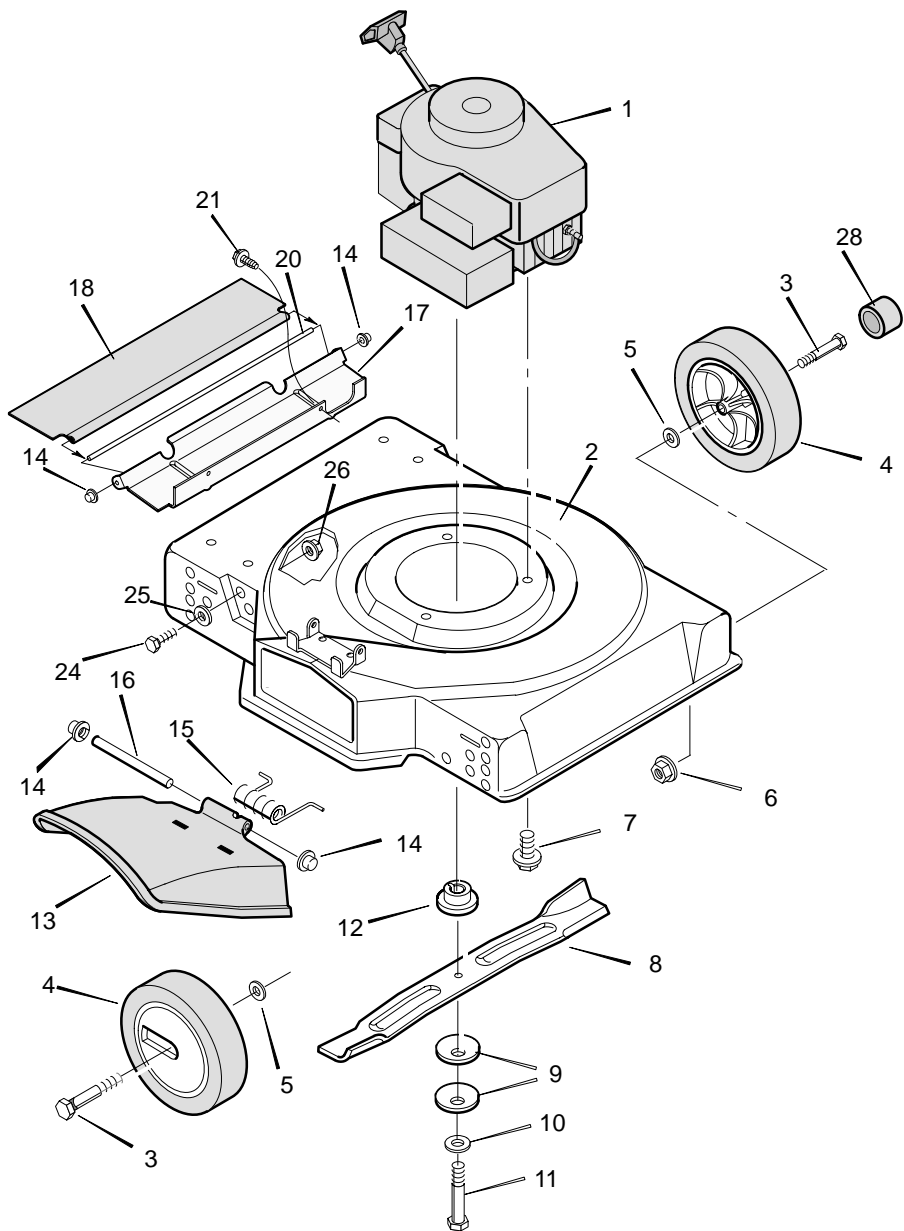

MODEL 20223x19A

KEY NO.	DESCRIPTION	20" PART NO.
1	Engine *	_____
2	Housing, For Non-Folding Handle	70120A
3	Bolt, Axle	9x10
4	Wheel and Tire #	_____
5	Washer	10851 Z
6	Locknut, Flange	15x68
7	Bolt, Engine	25x6
8	Blade	42785E701
9	Washer, Belleville	17x137
10	Washer	17x124
11	Bolt, Hex	1x142
12	Adapter, Blade	71056
13	Deflector, Chute	42919
14	Push-On Cap	28x42
15	Spring	166x5
16	Pin, Pivot	215x11 Z
17	Extension, Rear	71746E701
18	Deflector, Rear	71797
20	Pin	71800 Z
21	Screw	26x274
24	Bolt, Hex	1x85
25	Washer	18x31
26	Locknut, Flange	15x68
28	Hub Cap – Optional	20107

* Parts are available from an Authorized Service Center. See “Engines, Gasoline” or “Gasoline Engines” in the yellow pages of the telephone directory.

See the “Wheel And Tire Parts List” page.

MODEL 20223x19A

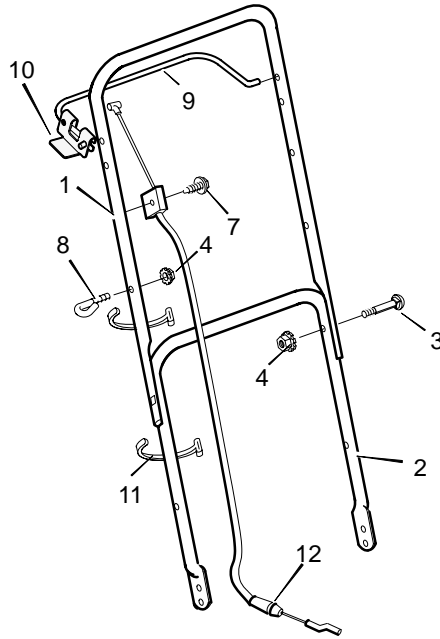

KEY NO.	DESCRIPTION	PART NO.
1	Handle, Upper – Straight	43838E701
2	Handle, Lower	71151E701
3	Screw	3x136
4	Locknut	15x116
7	Screw	26x220
8	Guide, Rope	43956
9	Engine Stop Lever – Straight	43786E700
10	Bracket, Stop Lever	43628 BC
11	Fastener, Cable	71372
12	Engine Stop Cable	43822

MODEL 20223x19A

LOOK AT THE ILLUSTRATIONS. SELECT THE WHEEL AND TIRE YOU WANT AND ORDER FROM THE FOLLOWING CHART.

A

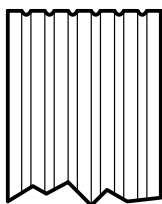
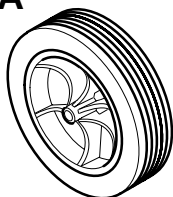

E

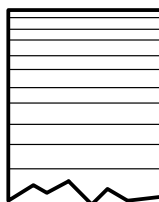
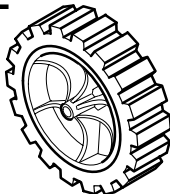

B

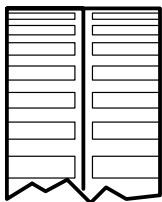
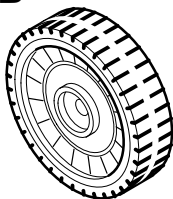

F

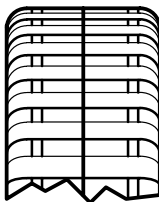

C

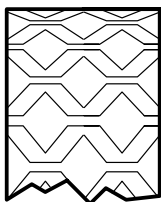
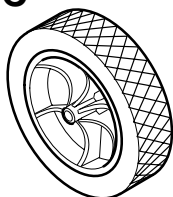

G

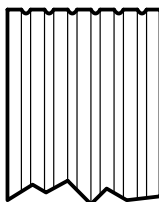
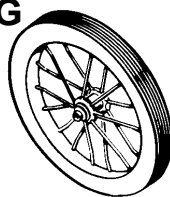

D

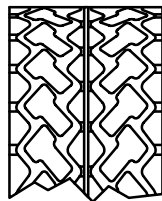

H

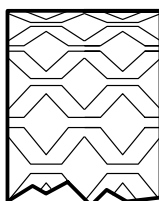
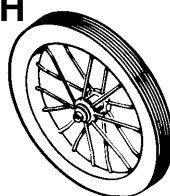

WHEEL SIZE & TYPE	A	B	C	D	E	F	G	H
6-inch Plastic, White	---	---	42174	---	---	---	---	---
7-inch Plastic, White	---	71148	20270	42172	---	---	---	---
7-inch Plastic, Gray	---	71596	71597	---	---	---	---	---
8-inch Plastic, White	20104	---	20271	42173	20105	43618	---	---
8-inch Plastic, Gray	71598	---	---	71599	71600	71132	---	---
8-inch Metal, White	43273	---	43414	---	43274	---	---	---
8-inch Ball Bearings, White	---	---	---	---	---	43724	---	---
8-inch Ball Bearings, Gray	---	---	---	---	---	71134	---	---
14-inch Spoke	---	---	---	---	---	---	42666	---
16-inch Spoke	---	---	---	---	---	---	70106	70119