

92

92 Hydro

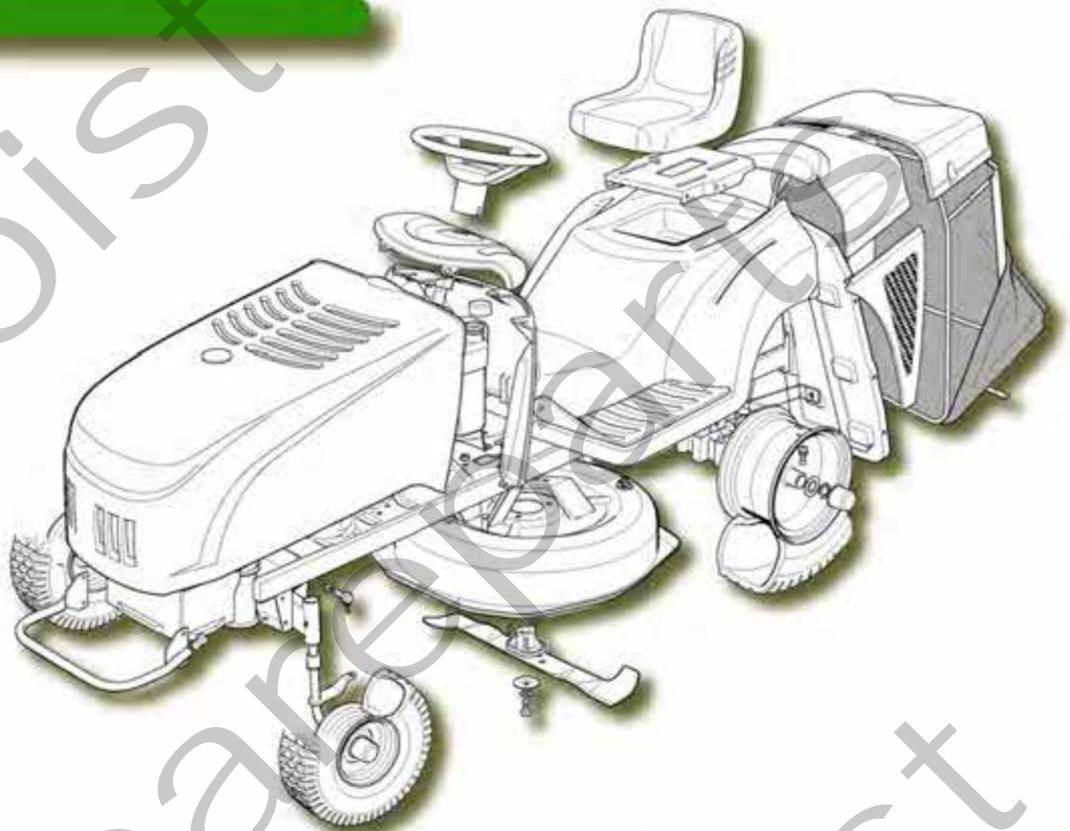

Catalogo delle parti di ricambio
Spare parts catalogue
Catalogue des pieces de rechange
Ersatzteilkatalog

2006



92 *92 hydro*

CATALOGO DELLE PARTI DI RICAMBIO
SPARE PARTS CATALOGUE
CATALOGUE DES PIECES DE RECHANGE
ERSATZTEILKATALOG

2006



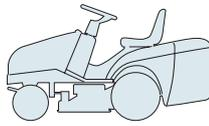

COME USARE IL CATALOGO

1. Generalità

Questo catalogo contiene tutte le informazioni necessarie per ordinare correttamente i pezzi di ricambio.

2. Struttura del catalogo

In ogni pagina del catalogo sono riportate le seguenti indicazioni:

HOW TO USE THE CATALOGUE

1. General information

This catalogue contains all the information necessary for correctly ordering spare parts.

2. Structure of the catalogue

Each page of the catalogue has these indications:

COMMENT UTILISER LE CATALOGUE

1. Généralités

Ce catalogue contient toutes les indications nécessaires pour commander correctement les pièces détachées.

2. Structure du catalogue

Les indications suivantes sont reportées sur chaque page du catalogue:

WIE IST DER KATALOG ZU BENUTZEN

1. Allgemeines

Dieser Katalog enthält alle Informationen, die für die korrekte Bestellung von Ersatzteilen erforderlich sind.

2. Aufbau des Katalogs

Auf jeder Seite des Katalogs sind die folgenden Angaben wiedergeben:

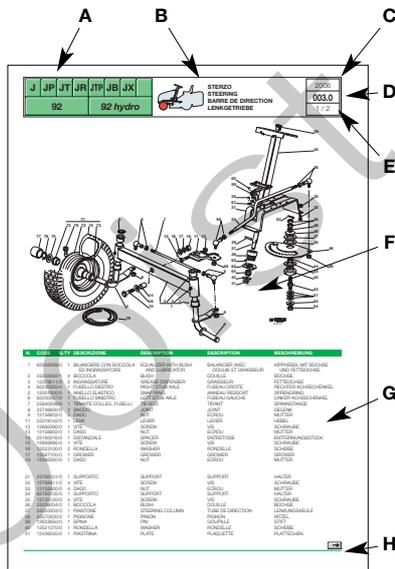

| GROUP | DESCRIPTION | DESCRIPTION | DESCRIPTION |
|-------|--------------------------|--------------------------|--------------------------|
| 1 | STEERING COLUMN | STEERING COLUMN | STEERING COLUMN |
| 2 | STEERING COLUMN ASSEMBLY | STEERING COLUMN ASSEMBLY | STEERING COLUMN ASSEMBLY |
| 3 | STEERING COLUMN ASSEMBLY | STEERING COLUMN ASSEMBLY | STEERING COLUMN ASSEMBLY |
| 4 | STEERING COLUMN ASSEMBLY | STEERING COLUMN ASSEMBLY | STEERING COLUMN ASSEMBLY |
| 5 | STEERING COLUMN ASSEMBLY | STEERING COLUMN ASSEMBLY | STEERING COLUMN ASSEMBLY |
| 6 | STEERING COLUMN ASSEMBLY | STEERING COLUMN ASSEMBLY | STEERING COLUMN ASSEMBLY |
| 7 | STEERING COLUMN ASSEMBLY | STEERING COLUMN ASSEMBLY | STEERING COLUMN ASSEMBLY |
| 8 | STEERING COLUMN ASSEMBLY | STEERING COLUMN ASSEMBLY | STEERING COLUMN ASSEMBLY |
| 9 | STEERING COLUMN ASSEMBLY | STEERING COLUMN ASSEMBLY | STEERING COLUMN ASSEMBLY |
| 10 | STEERING COLUMN ASSEMBLY | STEERING COLUMN ASSEMBLY | STEERING COLUMN ASSEMBLY |
| 11 | STEERING COLUMN ASSEMBLY | STEERING COLUMN ASSEMBLY | STEERING COLUMN ASSEMBLY |
| 12 | STEERING COLUMN ASSEMBLY | STEERING COLUMN ASSEMBLY | STEERING COLUMN ASSEMBLY |
| 13 | STEERING COLUMN ASSEMBLY | STEERING COLUMN ASSEMBLY | STEERING COLUMN ASSEMBLY |
| 14 | STEERING COLUMN ASSEMBLY | STEERING COLUMN ASSEMBLY | STEERING COLUMN ASSEMBLY |
| 15 | STEERING COLUMN ASSEMBLY | STEERING COLUMN ASSEMBLY | STEERING COLUMN ASSEMBLY |
| 16 | STEERING COLUMN ASSEMBLY | STEERING COLUMN ASSEMBLY | STEERING COLUMN ASSEMBLY |
| 17 | STEERING COLUMN ASSEMBLY | STEERING COLUMN ASSEMBLY | STEERING COLUMN ASSEMBLY |
| 18 | STEERING COLUMN ASSEMBLY | STEERING COLUMN ASSEMBLY | STEERING COLUMN ASSEMBLY |
| 19 | STEERING COLUMN ASSEMBLY | STEERING COLUMN ASSEMBLY | STEERING COLUMN ASSEMBLY |

A. Macchina o serie di macchine per le quali la pagina è valida.

B. Indicazione del gruppo con la raffigurazione in miniatura della sua collocazione sulla macchina.

C. Anno di produzione della macchina a cui si riferisce.

D. Numerazione progressiva della tavola, secondo il seguente criterio:
 - le prime tre cifre indicano il numero progressivo;
 - le eventuali lettere che seguono indicano le diverse versioni alternative di quel gruppo;
 - la cifra dopo il punto indica un eventuale aggiornamento nel corso della annualità indicata al punto 3.

Esempio:
005b.0 = Gruppo Motore
 005 TECUMSEH 13 HP
 b Prima stesura
 .0

A. Machine or machine series to which the page applies.

B. Indication of the unit with a miniature drawing showing its position on the machine.

C. Year of production of the machine concerned.

D. Progressive numbering of the table, arranged as follows:
 - the first three numbers are the progressive number;
 - any letters that follow will indicate the various alternative versions of that unit;
 - the number after the dot is for any updates during the year given at point 3.

Example:
005b.0 = Engine unit
 005 TECUMSEH 13 HP
 b First copy
 .0

A. La machine ou la série de machines auxquelles se réfère la page.

B. L'indication du groupe avec la représentation en miniature de sa position sur la machine.

C. L'année de fabrication de la machine concernée.

D. La numérotation progressive du tableau, selon le critère suivant:
 - les trois premiers chiffres indiquent le numéro progressif;
 - les éventuelles lettres qui suivent indiquent les différentes versions alternatives de ce groupe;
 - le chiffre après le point indique l'éventuelle mise à jour effectuée au cours de l'année indiquée au point 3.

Exemple:
005b.0 = Groupe Moteur
 005 TECUMSEH 13 HP
 b Première rédaction
 .0

A. Maschine oder Serie der Maschine, für welche die Seite gültig ist.

B. Bezeichnung der Gruppe mit einer Miniaturdarstellung ihrer Anbringung auf der Maschine.

C. Herstellungsjahr der betreffenden Maschine.

D. Progressive Numerierung der Tafel nach folgendem Kriterium:
 - die ersten drei Ziffern bezeichnen die progressive Nummer;
 - die eventuellen Buchstaben, die folgen, bezeichnen die verschiedenen alternativen Versionen dieser Gruppe;
 - die Ziffer nach dem Punkt bezeichnet einen eventuellen neueren Stand im Laufe des Jahrgangs, der in Punkt 3 angegeben ist.

Beispiel:
005b.0 = Motorgruppe
 005 TECUMSEH 13 HP
 b Erste Ausgabe
 .0





E. Numero della pagina e numero totale delle pagine necessarie per la descrizione del gruppo.

E. Page number and total number of pages necessary for the description of the unit.

E. Numéro de la page et nombre total des pages nécessaires pour la description du groupe.

E. Seitenzahl und Gesamtzahl der Seiten, die für die Beschreibung der Gruppe erforderlich sind.

F. Vista esplosa del gruppo.

F. Exploded view of the unit.

F. Vue éclatée du groupe.

F. Explosionszeichnung der Gruppe.

G. Descrizione completa dei singoli particolari, con codice e quantità di pezzi.

G. Full description of each part, with code number and number of pieces.

G. Description complète de chaque élément, avec code et quantité des pièces.

G. Vollständige Beschreibung der Einzelteile, mit Kodenummer und Menge der Teile.

H. Indicazione della presenza di altre pagine di seguito.

H. Indication of additional pages.

H. Indication de la présence d'autres pages successives.

H. Angabe über die Präsenz weiterer folgender Seiten.

Nelle pagine di seguito, sono riportate nuovamente le indicazioni relative ai punti A - C - D - E - G e H.

The additional pages repeat the indications as at points A - C - D - E - G and H.

Les pages qui suivent reportent, elles aussi, les indications concernant les points A - C - D - E - G et H.

Auf den nachfolgenden Seiten sind die Bezeichnungen, die sich auf die Punkte A - C - D - E - G und H beziehen, erneut wiedergegeben.

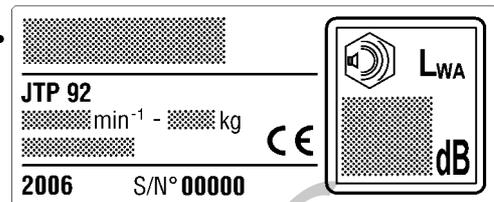
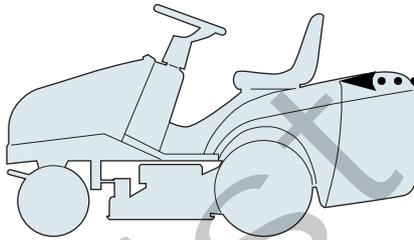

3. Ordine di ricambi

3. Spare parts order

3. Commande pièces détachées

3. Ersatzteilbestellungen

Prima di formulare un ordine di ricambi, accertare che il catalogo corrisponda all'anno di costruzione della macchina, riportato sulla targhetta di identificazione.

Before putting in an order for spare parts, make sure that the catalogue is the one applying to the machine's year of manufacture, as shown on the identification plate attached to the machine.

Avant de passer une commande pour des pièces détachées, s'assurer que le catalogue est celui correspondant à l'année de fabrication de la machine reportée sur la plaquette d'identification.

Ehe eine Ersatzteilbestellung geschrieben wird, muß man sich vergewissern, daß der Katalog mit dem Herstellungsjahr der Maschine übereinstimmt, auf dem Kennzeichenschild wiedergegeben.

Ogni ordine di ricambi deve necessariamente contenere:

Each spare parts order must include:

Chaque commande de pièces détachées doit obligatoirement contenir:

Jede Ersatzteilbestellung muß enthalten:

- modello della macchina;
- quantità di pezzi richiesta;
- descrizione (eventuale);
- numero di codice del pezzo;
- destinatario
- mezzo di spedizione.

- the model of the machine;
- the number of parts required;
- description (incidental);
- the code number for the item;
- the destination;
- the method of shipping.

- modèle de la machine;
- quantité de pièces demandée;
- description (éventuelle);
- numéro de code de la pièce;
- le destinataire;
- le moyen de transport.

- Modell der Maschine;
- Menge der angeforderten Teile;
- Bezeichnung (eventuell);
- Artikelnummer des Teils;
- Empfänger;
- Versandart.

Esempio di ordinazione:

An example of an order:

Exemple de commande:

Beispiel einer Bestellung:

Su una macchina J92 del 2006, con motore TECUMSEH da 13 HP si deve sostituire il silenziatore di scarico. Tale particolare è raffigurato nella tavola **005b.0** alla posizione **16**, a cui corrisponde il codice **82750005/0**.

The exhaust pipe silencer on a J92 machine, produced in 2006 with an TECUMSEH 13 HP engine, must be replaced. This part is shown in table **005b.0** in position **16**, and has the code number **82750005/0**.

Sur une machine J92 du 2006, avec moteur TECUMSEH de 13 CH, il faut remplacer le silencieux d'échappement. Cette pièce est représentée sur le tableau **005b.0** à la position **16**, correspondant au code **82750005/0**.

Auf einer Maschine J92 von 2006, mit Motor TECUMSEH mit 13 PS muß der Auspufftopf ersetzt werden. Dieses Einzelteil ist auf der Tafel **005b.0** unter der Position **16**, dargestellt, der dem Code **82750005/0** entspricht.

L'ordinazione sarà quindi:

The order will therefore be:

La commande sera donc formulée de la façon suivante:

Die Bestellung lautet demnach:

per J92:
n. 1 silenziatore cod. 82750005/0 da inviare a a mezzo

for J92:
1 silencer - code 82750005/0 to be sent to method of shipping

pour J92:
1 silencieux - code 82750005/0 à envoyer à par

Für J92:
1 Auspuff - Kode 82750005/0 zu versenden an mit

Nota

Note

Remarque

Anmerkung

Per le parti non codificate del motore e della trasmissione contrassegnate con (*), occorre rivolgersi al Costruttore.

For parts of the engine and the transmission without code numbers, marked by (*), it's necessary to contact the manufacturer.

Pour les pièces non codées du moteur et de la transmission, indiquées avec (*), il faut s'adresser au Fabricant.

Für die nicht codierten Teile des Motors und des Antriebs, die mit (*) gekennzeichnet sind, muß man sich an den Hersteller wenden.

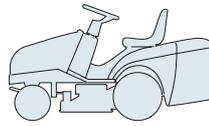

**TELAIO
CHASSIS
CHASSIS
RAHMENSATZ**

↪ [001](#)

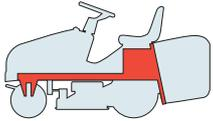

**CARROZZERIA
BODY
CARROSSERIE
KARROSSERIE**

- J ↪ [002](#)
- JP ↪ [002a](#)
- JT ↪ [002b](#)
- JR ↪ [002c](#)
- JTP ↪ [002d](#)
- JB ↪ [002e](#)
- JX ↪ [002f](#)

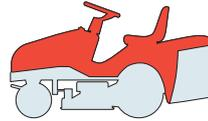

**STERZO
STEERING
BARRE DE DIRECTION
LENKGETRIEBE**

↪ [003](#)

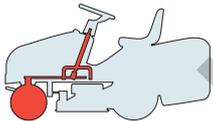

**COMANDO TRASMISSIONE E FRENO
DRIVE AND BRAKE CONTROLS
COMMANDE TRANSMISSION ET FREIN
GETRIEBE UND BREMSE ANTRIEB**

- 92 ↪ [004M](#)
- 92 Hydro ↪ [004Y](#)

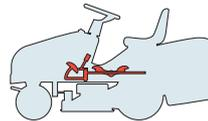

**MOTORE
ENGINE
MOTEUR
MOTOR**

- B&S 11,5 - 12 - 12,5
13,5 HP ↪ [005](#)
- B&S 15,5 HP ↪ [005a](#)
- TECUMSEH 11,5 - 13
13,5 HP ↪ [005b](#)
- HONDA GCV 520-14 HP ↪ [005c](#)
- KOHLER 16 HP ↪ [005d](#)

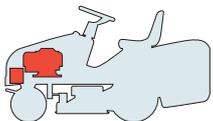

**TRASMISSIONE
TRANSMISSION
TRANSMISSION
GETRIEBE**

- 92 ↪ [006M](#)
- 92 Hydro ↪ [006Y](#)

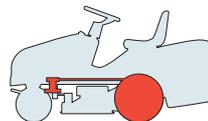

**SOLLEVAMENTO PIATTO DI TAGLIO
CUTTING PLATE LIFTING
SOULEVEMENT PLATEAU DE COUPE
SCHNEIDWERKZEUG AUFHEBESATZ**

↪ [007](#)

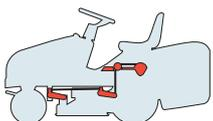

**PIATTO DI TAGLIO (1)
CUTTING PLATE (1)
PLATEAU DE COUPE (1)
SCHNEIDWERKZEUG (1)**

↪ [008](#)

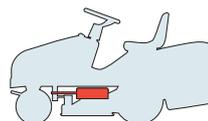



PIATTO DI TAGLIO (2)
CUTTING PLATE (2)
PLATEAU DE COUPE (2)
SCHNEIDWERKZEUG (2)

↪ [009](#)

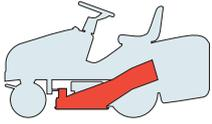

SACCO (1. - PARTE FISSA)
GRASSCATCHER (1. - FIXED PART)
BAC (1. - PARTIE FIXE)
AUFFANGSACK (1. - FESTER TEIL)

↪ [010](#)

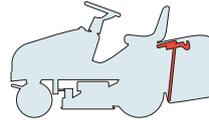

SACCO (2. - PARTE MOBILE)
GRASSCATCHER (2. - MOBILE PART)
BAC (2. - PARTIE MOBILE)
AUFFANGSACK (2. - BEWEGLICHER TEIL)

↪ [011](#)

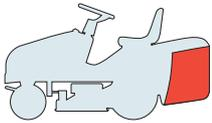

PARTI ELETTRICHE
ELECTRICAL PARTS
PARTIES ELECTRIQUES
ELETRISCHETEILE

B&S-TECUMSEH-KOHLER.. ↪ [012](#)

HONDA..... ↪ [012a](#)

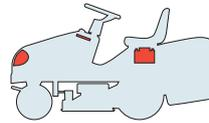

ACCESSORI A RICHIESTA
OPTIONALS ON REQUEST
ACCESSOIRES SUR DEMANDE
ZUBEHOERE NACH ANFRAGE

↪ [013](#)

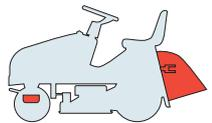

ETICHETTE
LABELS
ETIQUETTES
KLEBZETTEL

↪ [014](#)

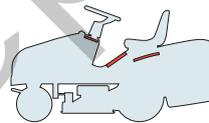

Spareparts Joist

J JP JT JR JTP JB JX

92

92 hydro

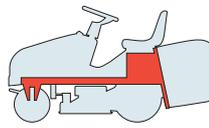

TELAIO
CHASSIS
CHASSIS
RAHMENSATZ

2006

001.0

1 / 2

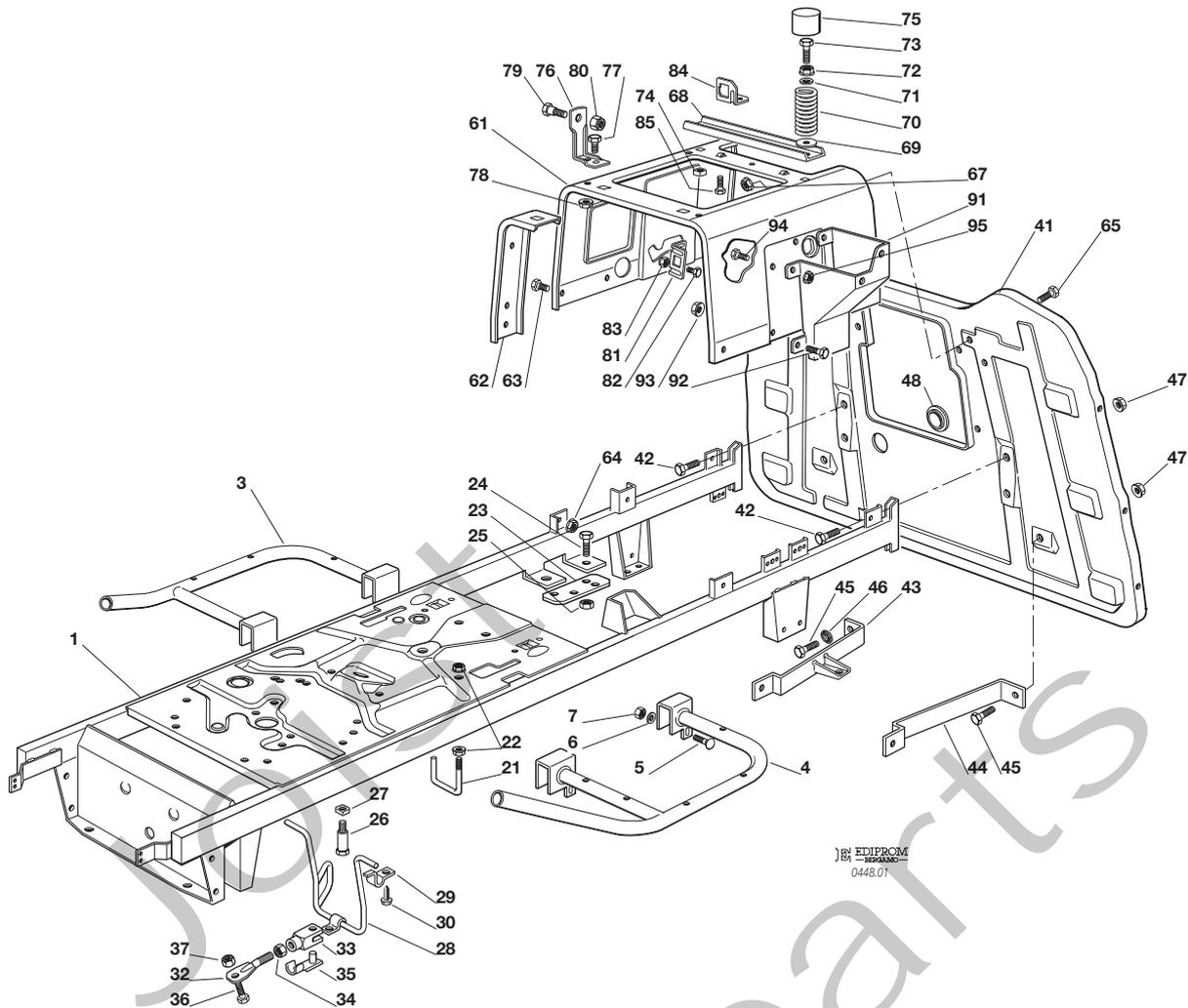

| N. | CODE | Q.TY | DESCRIZIONE | DESCRIPTION | DESCRIPTION | BESCHREIBUNG |
|----|------------|------|----------------------------|-------------------------|----------------------------|------------------------|
| 1 | 82800083/0 | 1 | TELAIO | CHASSIS | CHASSIS | RAHMENSATZ |
| 3 | 82800019/0 | 1 | SUPPORTO PEDANA DESTRA | RIGHT FOOTBOARD SUPPORT | MARCHEPIED DROITE SUPPORT | RECHTE FUSSBRETTHALTER |
| 4 | 82800021/0 | 1 | SUPPORTO PEDANA SINISTRA | LEFT FOOTBOARD SUPPORT | SUPPORT MARCHEPIED GAUCHE | LINKE FUSSBRETTHALTER |
| 5 | 12815240/0 | 4 | VITE | SCREW | VIS | SCHRAUBE |
| 6 | 12523040/0 | 4 | ROSETTA | WASHER | RONDELLE | SCHEIBE |
| 7 | 12154510/0 | 4 | DADO | NUT | ECROU | MUTTER |
| 21 | 25580019/0 | 1 | PIOLO GUIDACINGHIA (hydro) | BELT GUIDE (hydro) | GUIDE DE COURROIRE (hydro) | RIEMENFÜHRUNG (hydro) |
| 22 | 12292102/0 | 2 | DADO (hydro) | NUT (hydro) | ECROU (hydro) | MUTTER (hydro) |
| 23 | 25547101/0 | 2 | PIASTRINA (hydro) | PLATE (hydro) | PLAQUETTE (hydro) | PLATTE (hydro) |
| 24 | 12793102/0 | 2 | VITE (hydro) | SCREW (hydro) | VIS (hydro) | SCHRAUBE (hydro) |
| 25 | 12155000/0 | 2 | DADO (hydro) | NUT (hydro) | ECROU (hydro) | MUTTER (hydro) |
| 26 | 25580023/0 | 2 | PIOLO GUIDACINGHIA (mecc.) | BELT GUIDE (mech.) | GUIDE DE COURROIRE (mec.) | RIEMENFÜHRUNG (mech.) |
| 27 | 12360425/0 | 2 | DADO (mecc.) | NUT (mech.) | ECROU (mec.) | MUTTER (mech.) |
| 28 | 25270320/0 | 1 | GUIDACINGHIA | BELT GUIDE | GUIDE DE COURROIRE | RIEMENFÜHRUNG |
| 29 | 25774299/0 | 2 | PIASTRINA | PLATE | PLAQUETTE | PLATTE |
| 30 | 12734995/0 | 2 | VITE | SCREW | VIS | SCHRAUBE |
| 32 | 82000505/0 | 1 | TIRANTE | TIE ROD | TIRANT | SPANNSTANGE |
| 33 | 18399000/0 | 1 | FORCELLA | FORK | FOURCHE | GABEL |
| 34 | 12292100/0 | 1 | DADO | NUT | ECROU | MUTTER |
| 35 | 18210200/0 | 1 | CLIP | CLIP | CLIP | SPERRBOLZEN |
| 36 | 12793102/0 | 1 | VITE | SCREW | VIS | SCHRAUBE |
| 37 | 12154210/0 | 1 | DADO | NUT | ECROU | MUTTER |
| 41 | 82547021/3 | 1 | PIASTRA | PLATE | PLAQUE | PLATTE |
| 42 | 12792611/0 | 2 | VITE | SCREW | VIS | SCHRAUBE |
| 43 | 82650201/1 | 1 | RINFORZO DESTRO | PLATE STIFFENING, RIGHT | RENFORCEMENT PLAQUE, | RECHTE PLATTE- |





| N. | CODE | Q.TY | DESCRIZIONE | DESCRIPTION | DESCRIPTION | BESCHREIBUNG |
|----|------------|------|-------------------|------------------------|---------------------|--------------------|
| 44 | 25650046/0 | 1 | RINFORZO SINISTRO | PLATE STIFFENING, LEFT | RENFORCEMENT PLAQUE | LINKE PLATTE- |
| 45 | 12792611/0 | 4 | VITE | SCREW | VIS | SCHRAUBE |
| 46 | 12540260/0 | 1 | ROSETTA | WASHER | RONDELLE | SCHEIBE |
| 47 | 12292102/0 | 6 | DADO | NUT | ECROU | MUTTER |
| 48 | 22110275/0 | 1 | TAPPO | CAP | BOUCHON | TANKVERSCHLUSS |
| 61 | 25785119/1 | 1 | SUPPORTO SEDILE | SEAT SUPPORT | SUPPORT SIEGE | SITZHALTER |
| 62 | 25650055/0 | 2 | RINFORZO | PLATE STIFFENING | RENFORCEMENT PLAQUE | PLATTEVERSTAERKUG |
| 63 | 12790781/0 | 4 | VITE | SCREW | VIS | SCHRAUBE |
| 64 | 12292102/0 | 4 | DADO | NUT | ECROU | MUTTER |
| 65 | 12790781/0 | 4 | VITE | SCREW | VIS | SCHRAUBE |
| 67 | 12292102/0 | 4 | DADO | NUT | ECROU | MUTTER |
| 68 | 25650056/0 | 1 | RINFORZO | PLATE STIFFENING | RENFORCEMENT PLAQUE | PLATTEVERSTAERKUNG |
| 69 | 12523060/0 | 2 | RONDELLA | WASHER | RONDELLE | SCHEIBE |
| 70 | 25430205/1 | 2 | MOLLA | SPRING | RESSORT | FEDER |
| 71 | 12521350/0 | 2 | RONDELLA | WASHER | RONDELLE | SCHEIBE |
| 72 | 12293201/0 | 2 | DADO | NUT | ECROU | MUTTER |
| 73 | 25943001/0 | 2 | VITE | SCREW | VIS | SCHRAUBE |
| 74 | 12360420/0 | 2 | DADO | NUT | ECROU | MUTTER |
| 75 | 25122000/2 | 2 | CUFFIA | HOOD | PROTECTEUR | SCHUTZKASTEN |
| 76 | 25755008/0 | 2 | SQUADRETTA | BRACKET | EQUERRE-SUPPORT | WINKEL |
| 77 | 12792611/0 | 2 | VITE | SCREW | VIS | SCHRAUBE |
| 78 | 12293201/0 | 2 | DADO | NUT | ECROU | MUTTER |
| 79 | 22524970/2 | 2 | PERNO | PIN | PIVOT | BOLZEN |
| 80 | 12155010/0 | 2 | DADO | NUT | ECROU | MUTTER |
| 81 | 25755016/0 | 1 | SQUADRETTA | BRACKET | EQUERRE-SUPPORT | WINKEL |
| 82 | 12789000/0 | 2 | VITE | SCREW | VIS | SCHRAUBE |
| 83 | 12154330/0 | 2 | DADO | NUT | ECROU | MUTTER |
| 84 | 25755025/1 | 1 | SQUADRETTA | BRACKET | EQUERRE-SUPPORT | WINKEL |
| 85 | 12731580/0 | 2 | VITE | SCREW | VIS | SCHRAUBE |
| 91 | 25785057/0 | 1 | SUPPORTO | SUPPORT | SUPPORT | HALTER |
| 92 | 12790781/0 | 2 | VITE | SCREW | VIS | SCHRAUBE |
| 93 | 12292102/0 | 2 | DADO | NUT | ECROU | MUTTER |
| 94 | 12790781/0 | 2 | VITE | SCREW | VIS | SCHRAUBE |
| 95 | 12292102/0 | 2 | DADO | NUT | ECROU | MUTTER |

J JP JT JR JTP JB JX

92

92 hydro

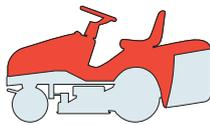

CARROZZERIA
BODY
CARROSSERIE
KARROSSERIE

2006

002.0

1 / 2

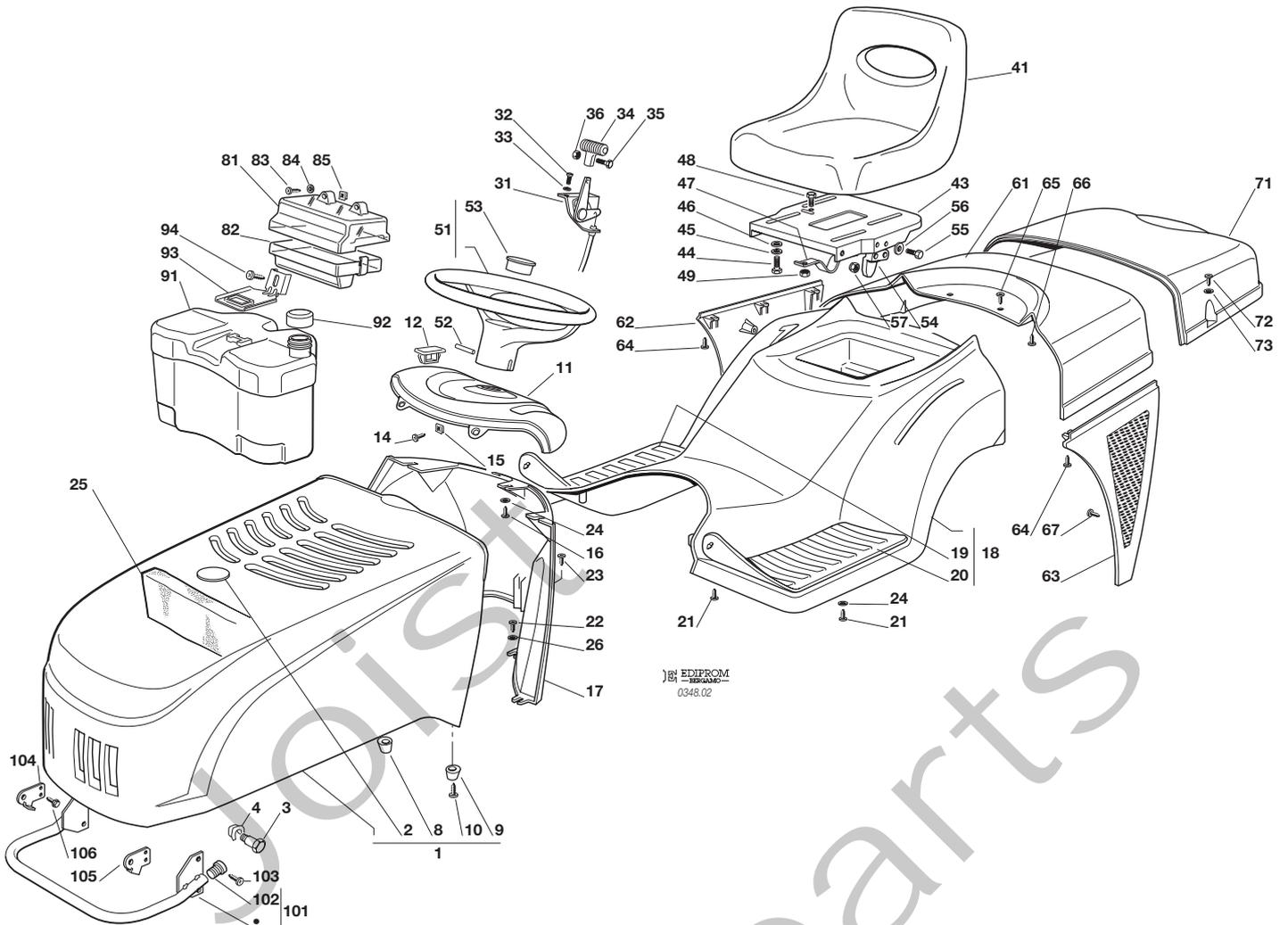

EDIPROM
0348.02

| N. | CODE | Q.TY | DESCRIZIONE | DESCRIPTION | DESCRIPTION | BESCHREIBUNG |
|----|----------------------------------------|------|--------------------------------------------------|----------------------------------------------|-----------------------------------------------|-------------------------------------------|
| 1 | 82076902/1 82076903/0 82076905/0 | 1 | COFANO ROSSO VERDE BLU | ENGINE HOOD RED GREEN BLUE | CAPOT ROUGE VERT BLEU | HAUBESATZ ROT GRÜN BLAU |
| 2 | 25547025/1 25547026/0 25547028/0 | 1 | PIASTRINA ROSSA VERDE BLU | PLATE RED GREEN BLUE | PLAQUE ROUGE VERT BLEU | PLATTE ROT GRÜN BLAU |
| 3 | 25510045/0 | 2 | PERNO | PIN | PIVOT | BOLZEN |
| 4 | 12436050/0 | 2 | PIASTRINA | PLATE | PLAQUE | PLATTE |
| 8 | 25580012/0 | 1 | PIOLO DESTRO | RIGHT PIN | BONDON DROITE | RECHTE DÜBEL |
| 9 | 25580013/0 | 1 | PIOLO SINISTRO | LEFT PIN | BONDON GAUCHE | LINKE DÜBEL |
| 10 | 12727356/0 | 2 | VITE | SCREW | VIS | SCHRAUBE |
| 11 | 25120164/1 | 1 | CRUSCOTTO | DASHBOARD | TABEAU COMMANDES | KONSOLE |
| 12 | 25547054/1 | 1 | PIASTRINA | PLATE | PLAQUE | PLATTE |
| 14 | 12735110/0 | 2 | VITE | SCREW | VIS | SCHRAUBE |
| 15 | 12437502/0 | 2 | PIASTRINA | PLATE | PLAQUE | PLATTE |
| 16 | 12735402/0 | 3 | VITE | SCREW | VIS | SCHRAUBE |
| 17 | 25785035/3 | 1 | SUPPORTO CRUSCOTTO | DASHBOARD SUPPORT | SUPPORT TABLEAU COMM. | KONSOLEHALTER |
| 18 | 82110001/3 82110002/2 82110004/2 | 1 | COPERTURA RUOTE ROSSO VERDE BLU | WHEELS COVER RED GREEN BLUE | COUVRE-ROUES ROUGE VERT BLEU | RADENKAPPE ROT GRÜN BLAU |
| 18 | 82110007/3 82110008/2 82110010/2 | 1 | COPERTURA RUOTE (hydro) ROSSO VERDE BLU | WHEELS COVER (hydro) RED GREEN BLUE | COUVRE-ROUES (hydro) ROUGE VERT BLEU | RADENKAPPE (hydro) ROT GRÜN BLAU |
| 19 | 25110264/1 | 1 | COPRIPEDANA DESTRA | RIGHT FOOTBOARDCOVER | COUVRE MARCHEPIED DRO. | RECHTE FUSSBRETTDECKEL |
| 20 | 25110263/1 | 1 | COPRIPEDANA SINISTRA | LEFT FOOTBOARD COVER | COUVRE MARCHEPIED GAU. | LINKE FUSSBRETTDECKEL |
| 21 | 12735410/0 | 6 | VITE | SCREW | VIS | SCHRAUBE |
| 22 | 12735402/0 | 4 | VITE | SCREW | VIS | SCHRAUBE |





| N. | CODE | Q.TY | DESCRIZIONE | DESCRIPTION | DESCRIPTION | BESCHREIBUNG |
|-----|------------|------|---------------------------|-----------------------|--------------------------|-------------------------|
| 23 | 12728680/0 | 1 | VITE | SCREW | VIS | SCHRAUBE |
| 24 | 12523040/0 | 5 | ROSETTA | WASHER | RONDELLE | SCHEIBE |
| 25 | 25730005/1 | 1 | SEPARATORE ASPIRAZ. (10) | INTAKE SEPARATOR (10) | SEPARATEUR ASPIRAT. (10) | AUGENABSCHIEDER (10) |
| 26 | 12523050/0 | 4 | ROSETTA | WASHER | RONDELLE | SCHEIBE |
| 31 | 82000207/0 | 1 | ACCELERATORE | ACCELERATOR | ACCELERATEUR | GAS ZUG |
| 32 | 12788512/0 | 2 | VITE | SCREW | VIS | SCHRAUBE |
| 33 | 12581200/0 | 2 | GROWER | GROWER | GROWER | GROWER |
| 34 | 25394501/0 | 1 | MANOPOLINA | HANDLE | POIGNE | GRIFF |
| 35 | 12726388/0 | 1 | VITE | SCREW | VIS | SCHRAUBE |
| 36 | 12290800/0 | 1 | DADO | NUT | ECROU | MUTTER |
| 41 | 25722453/1 | 1 | SEDILE | SEAT | SIEGE | SITZ |
| 43 | 25547033/1 | 1 | PIASTRA | PLATE | PLAQUE | PLATTE |
| 44 | 12793101/0 | 4 | VITE | SCREW | VIS | SCHRAUBE |
| 45 | 12583500/0 | 4 | GROWER | GROWER | GROWER | GROWER |
| 46 | 12523060/0 | 4 | RONDELLA | WASHER | RONDELLE | SCHEIBE |
| 47 | 25430223/2 | 1 | MOLLA | SPRING | RESSORT | FEDER |
| 48 | 12789000/0 | 1 | VITE | SCREW | VIS | SCHRAUBE |
| 49 | 12154330/0 | 1 | DADO | NUT | ECROU | MUTTER |
| 51 | 25961201/0 | 1 | VOLANTE | STEERING WHEEL | VOLANT | LENKRAD |
| 52 | 12620299/0 | 1 | SPINA | PIN | GOUPILLE | STIFT |
| 53 | 25120230/0 | 1 | TAPPO | CAP | BOUCHON | STOPFEN |
| 54 | 27063021/1 | 1 | CAMMA | CAM | CAME | NOCKEN |
| 55 | 12789100/0 | 2 | VITE | SCREW | VIS | SCHRAUBE |
| 56 | 12523020/0 | 2 | RONDELLA | WASHER | RONDELLE | SCHEIBE |
| 57 | 12154330/0 | 2 | DADO | NUT | ECROU | MUTTER |
| 61 | • | 1 | COPERTURA | COVER | COUVRE | KAPPE |
| | 25110179/1 | | ROSSO | RED | ROUGE | ROT |
| | 25110199/1 | | VERDE | GREEN | VERT | GRÜN |
| | 25110201/1 | | BLU | BLUE | BLEU | BLAU |
| | 25110300/0 | | NERO | BLACK | NOIR | SCHWARZ |
| 62 | 25600033/0 | 1 | PROTEZIONE DESTRA, NERA | RIGHT GUARD, BLACK | PROTECTION DROITE, NOIR | RECHTE SCHUTZE, SCHWARZ |
| 63 | 25600034/0 | 1 | PROTEZIONE SINISTRA, NERA | LEFT GUARD, BLACK | PROTECTION GAUCHE, NOIR | LINKE SCHUTZE, SCHWARZ |
| 64 | 12735402/0 | 6 | VITE | SCREW | VIS | SCHRAUBE |
| 65 | 12734995/0 | 2 | VITE | SCREW | VIS | SCHRAUBE |
| 66 | 12735402/0 | 3 | VITE | SCREW | VIS | SCHRAUBE |
| 67 | 12735402/0 | 6 | VITE | SCREW | VIS | SCHRAUBE |
| 71 | • | 1 | COPERTURA SACCO | GRASS-CATCHER COVER | COUVRE-BAC | SACKKAPPE |
| | 25110178/2 | | ROSSO | RED | ROUGE | ROT |
| | 25110196/1 | | VERDE | GREEN | VERT | GRÜN |
| | 25110198/1 | | BLU | BLUE | BLEU | BLAU |
| | 25110299/0 | | NERO | BLACK | NOIR | SCHWARZ |
| 72 | 12729601/1 | 4 | VITE | SCREW | VIS | SCHRAUBE |
| 73 | 12521331/0 | 4 | RONDELLA | WASHER | RONDELLE | SCHEIBE |
| 81 | 25600020/0 | 1 | PROTEZIONE SUPERIORE | UPPER GUARD | PROTECTION SUPERIEUR | OBERSCHUTZ |
| 82 | 25600021/1 | 1 | PROTEZIONE INFERIORE | LOWER GUARD | PROTECTION INFERIEUR | UNTERSCHUTZ |
| 83 | 12728460/0 | 2 | VITE | SCREW | VIS | SCHRAUBE |
| 84 | 12521320/0 | 2 | ROSETTA | WASHER | RONDELLE | SCHEIBE |
| 85 | 12437502/0 | 2 | PIASTRINA | PLATE | PLAQUE | PLÄTTE |
| 91 | 25735116/2 | 1 | SERBATOIO | TANK | RESERVOIR | TANK |
| 92 | 25795000/1 | 1 | TAPPO | CAP | BOUCHON | TANKVERSCHLUSS |
| 93 | 25774258/0 | 1 | SUPPORTO | SUPPORT | SUPPORT | HALTER |
| 94 | 12735110/0 | 1 | VITE | SCREW | VIS | SCHRAUBE |
| 101 | 82869011/0 | 1 | PROTEZIONE SILENZIATORE | MUFFLER PROTECTION | PROTECTION SILENCIEUX | AUSPUFFSCHUTZ |
| 102 | 18566110/0 | 2 | PUNTALE | CAP | BOUCHON | PFROPFEN |
| 103 | 12734995/0 | 4 | VITE | SCREW | VIS | SCHRAUBE |
| 104 | 25547089/0 | 1 | PIASTRINA DESTRA | RIGHT PLATE | PLAQUE DROITE | RECHTE PLATTE |
| 105 | 25547091/0 | 1 | PIASTRINA SINISTRA | LEFT PLATE | PLAQUE GAUCHE | LINKE PLATTE |
| 106 | 12731580/0 | 4 | VITE | SCREW | VIS | SCHRAUBE |

J JP JT JR JTP JB JX

92

92 hydro

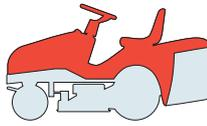

CARROZZERIA
BODY
CARROSSERIE
KARROSSERIE

2006

002a.0

1 / 2

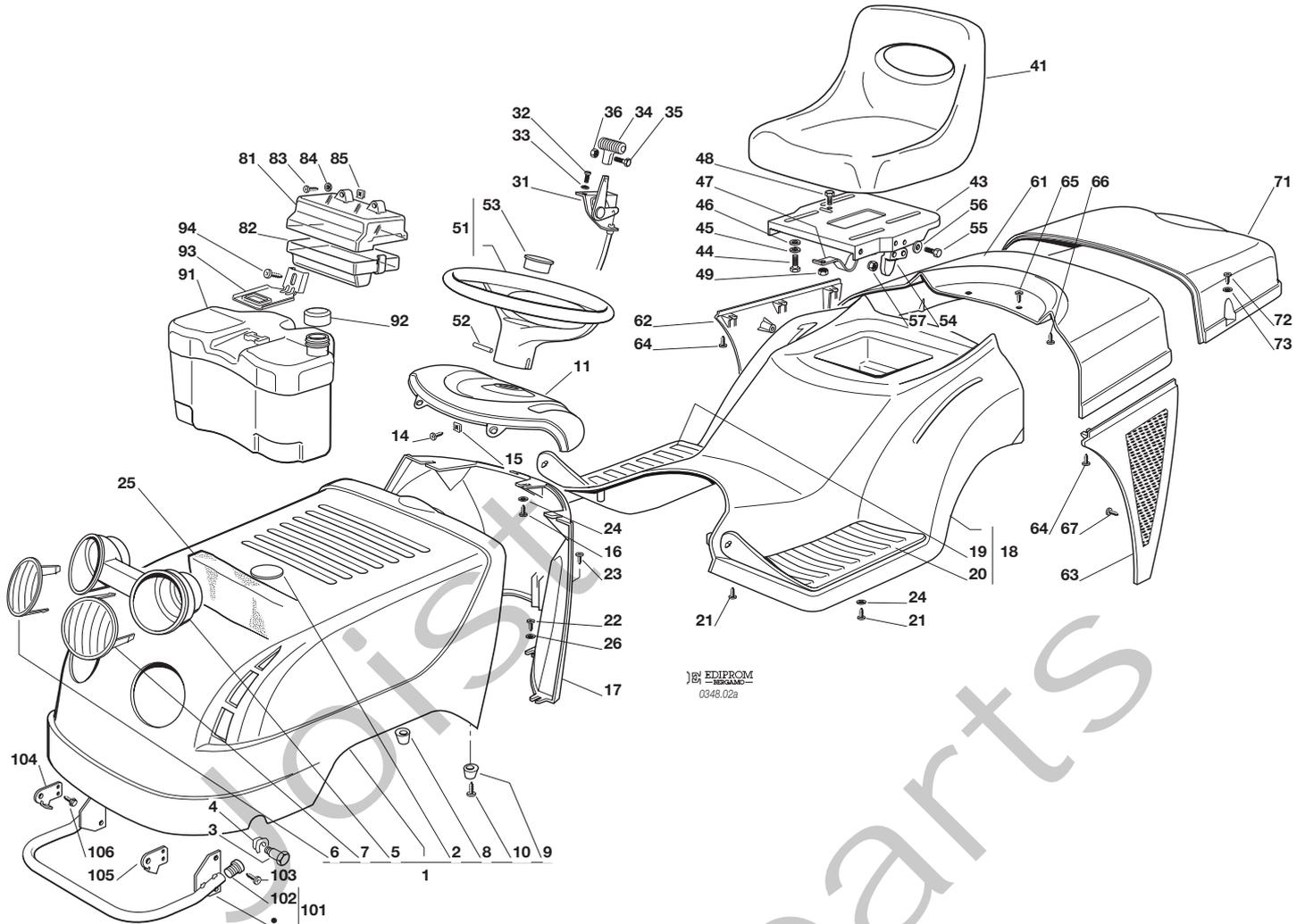

EDIPROM
0348.02a

| N. | CODE | Q.TY | DESCRIZIONE | DESCRIPTION | DESCRIPTION | BESCHREIBUNG |
|----|------------|------|----------------------------------|-----------------------------|-------------------------------|---------------------------|
| 1 | 82076897/1 | 1 | COFANO ROSSO | ENGINE HOOD RED | CAPOT ROUGE | HAUBESATZ ROT |
| | 82076898/0 | | VERDE | GREEN | VERT | GRÜN |
| | 82076900/0 | | BLU | BLUE | BLEU | BLAU |
| 2 | 25547025/1 | 1 | PIASTRINA ROSSA | PLATE RED | PLAQUE ROUGE | PLATTE ROT |
| | 25547026/0 | | VERDE | GREEN | VERT | GRÜN |
| | 25547028/0 | | BLU | BLUE | BLEU | BLAU |
| 3 | 25510039/0 | 2 | PERNO | PIN | PIVOT | BOLZEN |
| 4 | 12436050/0 | 2 | PIASTRINA | PLATE | PLAQUE | PLATTE |
| 5 | 25485002/0 | 1 | PARABOLA FARI | LIGHTS PARABOLA | PARABOLE | SCHEINWERFERPARABEL |
| 6 | 25410866/0 | 1 | MASCHERINA DESTRA | RIGHT GRILL | PANNEAU DROITE | RECHTE SCHUTZ |
| 7 | 25410867/0 | 1 | MASCHERINA SINISTRA | LEFT GRILL | PANNEAU GAUCHE | LINKE SCHUTZ |
| 8 | 25580012/0 | 1 | PIOLO DESTRO | RIGHT PIN | BONDON DROITE | RECHTE DÜBEL |
| 9 | 25580013/0 | 1 | PIOLO SINISTRO | LEFT PIN | BONDON GAUCHE | LINKE DÜBEL |
| 10 | 12727356/0 | 2 | VITE | SCREW | VIS | SCHRAUBE |
| 11 | 25120164/1 | 1 | CRUSCOTTO | DASHBOARD | TABEUAU COMMANDES | KONSOLE |
| 14 | 12735110/0 | 2 | VITE | SCREW | VIS | SCHRAUBE |
| 15 | 12437502/0 | 2 | PIASTRINA | PLATE | PLAQUE | PLATTE |
| 16 | 12735402/0 | 3 | VITE | SCREW | VIS | SCHRAUBE |
| 17 | 25785035/3 | 1 | SUPPORTO CRUSCOTTO | DASHBOARD SUPPORT | SUPPORT TABLEAU COMM. | KONSOLEHALTER |
| 18 | 82110001/3 | 1 | COPERTURA RUOTE ROSSO | WHEELS COVER RED | COUVRE-ROUES ROUGE | RADENKAPPE ROT |
| | 82110002/2 | | VERDE | GREEN | VERT | GRÜN |
| | 82110004/2 | | BLU | BLUE | BLEU | BLAU |
| 18 | 82110007/3 | 1 | COPERTURA RUOTE (hydro) ROSSO | WHEELS COVER (hydro) RED | COUVRE-ROUES (hydro) ROUGE | RADENKAPPE (hydro) ROT |
| | 82110008/2 | | VERDE | GREEN | VERT | GRÜN |
| | 82110010/2 | | BLU | BLUE | BLEU | BLAU |
| 19 | 25110264/1 | 1 | COPRIPEDANA DESTRA | RIGHT FOOTBOARDCOVER | COUVRE MARCHEPIED DRO. | RECHTE FUSSBRETTDECKEL |
| 20 | 25110263/1 | 1 | COPRIPEDANA SINISTRA | LEFT FOOTBOARD COVER | COUVRE MARCHEPIED GAU. | LINKE FUSSBRETTDECKEL |





| N. | CODE | Q.TY | DESCRIZIONE | DESCRIPTION | DESCRIPTION | BESCHREIBUNG |
|-----|------------|------|---------------------------|----------------------------|--------------------------|-------------------------|
| 21 | 12735410/0 | 6 | VITE | SCREW | VIS | SCHRAUBE |
| 22 | 12735402/0 | 4 | VITE | SCREW | VIS | SCHRAUBE |
| 23 | 12728680/0 | 1 | VITE | SCREW | VIS | SCHRAUBE |
| 24 | 12523040/0 | 5 | ROSETTA | WASHER | RONDELLE | SCHEIBE |
| 25 | 25730005/1 | 1 | SEPARATORE ASPIRAZ. (10) | INTAKE SEPARATOR (10) | SEPARATEUR ASPIRAT. (10) | AUGENABSCHIEDER (10) |
| 26 | 12523050/0 | 4 | ROSETTA | WASHER | RONDELLE | SCHEIBE |
| 31 | 82000207/0 | 1 | ACCELERATORE | ACCELERATOR | ACCELERATEUR | GAS ZUG |
| 32 | 12788512/0 | 2 | VITE | SCREW | VIS | SCHRAUBE |
| 33 | 12581200/0 | 2 | GROWER | GROWER | GROWER | GROWER |
| 34 | 25394501/0 | 1 | MANOPOLINA | HANDLE | POIGNE | GRIFF |
| 35 | 12726388/0 | 1 | VITE | SCREW | VIS | SCHRAUBE |
| 36 | 12290800/0 | 1 | DADO | NUT | ECROU | MUTTER |
| 41 | 25722453/1 | 1 | SEDILE | SEAT | SIEGE | SITZ |
| 43 | 25547033/1 | 1 | PIASTRA | PLATE | PLAQUE | PLATTE |
| 44 | 12793101/0 | 4 | VITE | SCREW | VIS | SCHRAUBE |
| 45 | 12583500/0 | 4 | GROWER | GROWER | GROWER | GROWER |
| 46 | 12523060/0 | 4 | RONDELLA | WASHER | RONDELLE | SCHEIBE |
| 47 | 25430223/2 | 1 | MOLLA | SPRING | RESSORT | FEDER |
| 48 | 12789000/0 | 1 | VITE | SCREW | VIS | SCHRAUBE |
| 49 | 12154330/0 | 1 | DADO | NUT | ECROU | MUTTER |
| 51 | 25961201/0 | 1 | VOLANTE | STEERING WHEEL | VOLANT | LENKRAD |
| 52 | 12620299/0 | 1 | SPINA | PIN | GOUPILLE | STIFT |
| 53 | 25120230/0 | 1 | TAPPO | CAP | BOUCHON | STOPFEN |
| 54 | 27063021/1 | 1 | CAMMA | CAM | CAME | NOCKEN |
| 55 | 12789100/0 | 2 | VITE | SCREW | VIS | SCHRAUBE |
| 56 | 12523020/0 | 2 | RONDELLA | WASHER | RONDELLE | SCHEIBE |
| 57 | 12154330/0 | 2 | DADO | NUT | ECROU | MUTTER |
| 61 | 25110179/1 | 1 | COPERTURA ROSSO | COVER RED | COUVRE ROUGE | KAPPE ROT |
| | 25110199/1 | | VERDE | GREEN | VERT | GRÜN |
| | 25110201/1 | | BLU | BLUE | BLEU | BLAU |
| | 25110300/0 | | NERO | BLACK | NOIR | SCHWARZ |
| 62 | 25600033/0 | 1 | PROTEZIONE DESTRA, NERA | RIGHT GUARD, BLACK | PROTECTION DROITE, NOIR | RECHTE SCHUTZE, SCHWARZ |
| 63 | 25600034/0 | 1 | PROTEZIONE SINISTRA, NERA | LEFT GUARD, BLACK | PROTECTION GAUCHE, NOIR | LINKE SCHUTZE, SCHWARZ |
| 64 | 12735402/0 | 6 | VITE | SCREW | VIS | SCHRAUBE |
| 65 | 12734995/0 | 2 | VITE | SCREW | VIS | SCHRAUBE |
| 66 | 12735402/0 | 3 | VITE | SCREW | VIS | SCHRAUBE |
| 67 | 12735402/0 | 6 | VITE | SCREW | VIS | SCHRAUBE |
| 71 | 25110178/2 | 1 | COPERTURA SACCO ROSSO | GRASS-CATCHER COVER RED | COUVRE-BAC ROUGE | SACKKAPPE ROT |
| | 25110196/1 | | VERDE | GREEN | VERT | GRÜN |
| | 25110198/1 | | BLU | BLUE | BLEU | BLAU |
| | 25110299/0 | | NERO | BLACK | NOIR | SCHWARZ |
| 72 | 12729601/1 | 4 | VITE | SCREW | VIS | SCHRAUBE |
| 73 | 12521331/0 | 4 | RONDELLA | WASHER | RONDELLE | SCHEIBE |
| 81 | 25600020/0 | 1 | PROTEZIONE SUPERIORE | UPPER GUARD | PROTECTION SUPERIEUR | OBERSCHUTZ |
| 82 | 25600021/1 | 1 | PROTEZIONE INFERIORE | LOWER GUARD | PROTECTION INFERIEUR | UNTERSCHUTZ |
| 83 | 12728460/0 | 2 | VITE | SCREW | VIS | SCHRAUBE |
| 84 | 12521320/0 | 2 | ROSETTA | WASHER | RONDELLE | SCHEIBE |
| 85 | 12437502/0 | 2 | PIASTRINA | PLATE | PLAQUE | PLÄTTE |
| 91 | 25735116/2 | 1 | SERBATOIO | TANK | RESERVOIR | TANK |
| 92 | 25795000/1 | 1 | TAPPO | CAP | BOUCHON | TANKVERSCHLUSS |
| 93 | 25774258/0 | 1 | SUPPORTO | SUPPORT | SUPPORT | HALTER |
| 94 | 12735110/0 | 1 | VITE | SCREW | VIS | SCHRAUBE |
| 101 | 82869011/0 | 1 | PROTEZIONE SILENZIATORE | MUFFLER PROTECTION | PROTECTION SILENCIEUX | AUSPUFFSCHUTZ |
| 102 | 18566110/0 | 2 | PUNTALE | CAP | BOUCHON | PFRÖPFEN |
| 103 | 12734995/0 | 4 | VITE | SCREW | VIS | SCHRAUBE |
| 104 | 25547089/0 | 1 | PIASTRINA DESTRA | RIGHT PLATE | PLAQUE DROITE | RECHTE PLATTE |
| 105 | 25547091/0 | 1 | PIASTRINA SINISTRA | LEFT PLATE | PLAQUE GAUCHE | LINKE PLATTE |
| 106 | 12731580/0 | 4 | VITE | SCREW | VIS | SCHRAUBE |

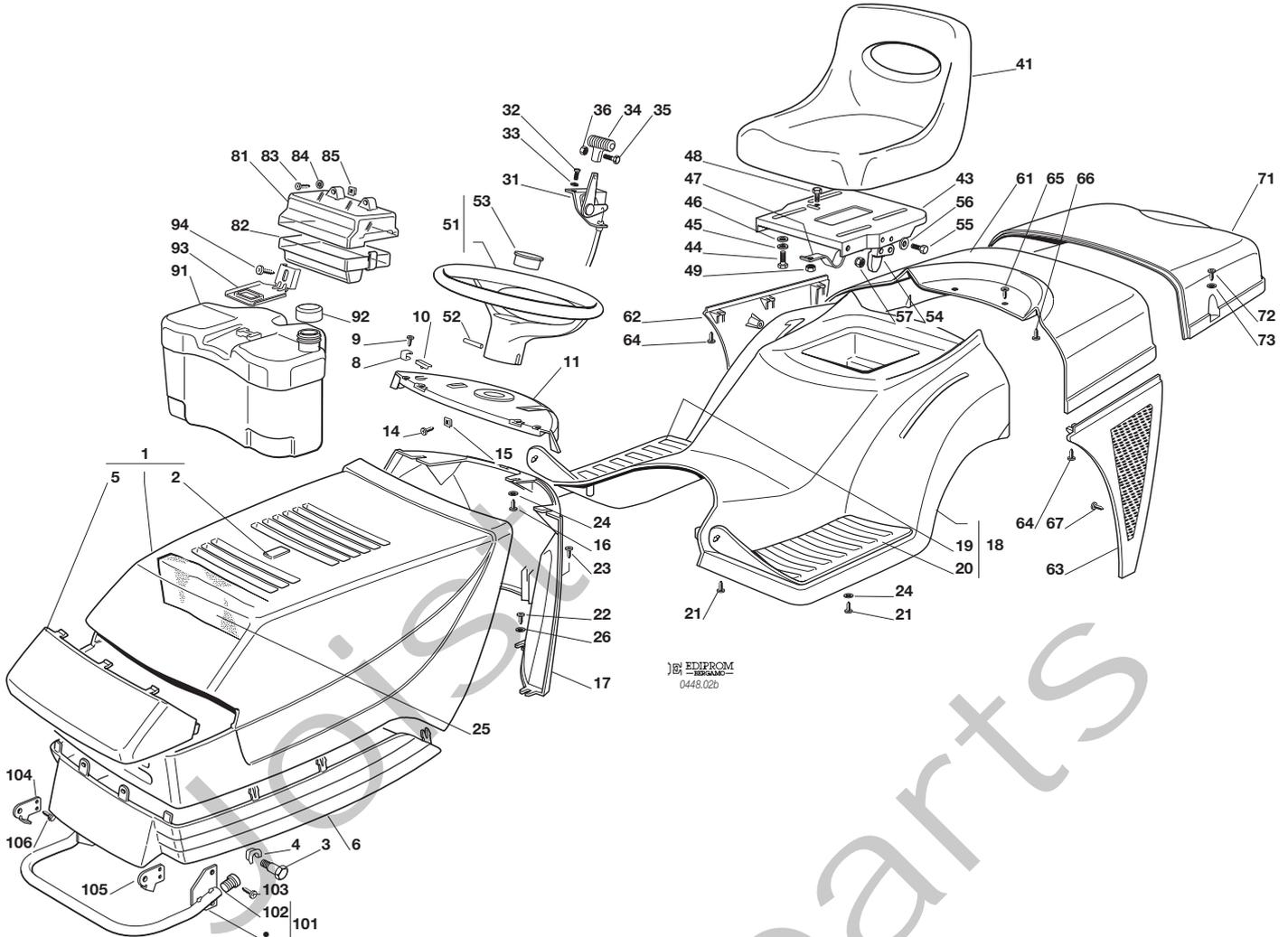
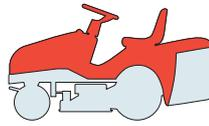

EDIPROM
0448.02b

| N. | CODE | Q.TY | DESCRIZIONE | DESCRIPTION | DESCRIPTION | BESCHREIBUNG |
|----|------------------------------------------------------|------|--------------------------------------------------------|-----------------------------------------------------|-----------------------------------------------------|------------------------------------------------------|
| 1 | 82076802/2 82076803/0 82076932/0 82076808/0 | 1 | COFANO SUPERIORE ROSSO VERDE ARANCIONE BLU | UPPER ENGINE HOOD RED GREEN ORANGE BLUE | CAPOT SUPERIEURE ROUGE VERT ORANGE BLEU | OBERHAUBESATZ ROT GRÜN DUNKELORANGE BLAU |
| 2 | 25547016/2 25547015/0 25547144/0 25547024/0 | 1 | PIASTRINA ROSSA VERDE ARANCIONE BLU | PLATE RED GREEN ORANGE BLUE | PLAQUE ROUGE VERT ORANGE BLEU | PLATTE ROT GRÜN DUNKELORANGE BLAU |
| 3 | 25510023/1 | 2 | PERNO | PIN | PIVOT | BOLZEN |
| 4 | 12436050/0 | 2 | PIASTRINA | PLATE | PLAQUE | PLATTE |
| 5 | 25410858/0 | 1 | MASCHERINA | GRILL | PANNEAU | SCHUTZ |
| 6 | 25076802/0 | 1 | COFANO INFERIORE | LOWER ENGINE HOOD | CAPOT INFERIEURE | UNTERHAUBESATZ |
| 8 | 25430215/0 | 2 | MOLLA AGGANCIO | COUPLING SPRING | RESSORT ACCROCHAGE | KUPPLUNGSFEDER |
| 9 | 12728450/0 | 2 | VITE | SCREW | VIS | SCHRAUBE |
| 10 | 25260000/0 | 2 | GOMMINO | GROMMET | PROTECTION | SCHUTZ |
| 11 | 25120151/0 | 1 | CRUSCOTTO | DASHBOARD | TABEUAU COMMANDES | KONSOLE |
| 14 | 12735110/0 | 2 | VITE | SCREW | VIS | SCHRAUBE |
| 15 | 12437502/0 | 2 | PIASTRINA | PLATE | PLAQUE | PLATTE |
| 16 | 12735402/0 | 3 | VITE | SCREW | VIS | SCHRAUBE |
| 17 | 25785062/2 | 1 | SUPPORTO CRUSCOTTO | DASHBOARD SUPPORT | SUPPORT TABLEAU COMM. | SUPPORTHALTER |
| 18 | 82110001/3 82110002/2 82110015/2 82110004/2 | 1 | COPERTURA RUOTE ROSSO VERDE ARANCIONE BLU | WHEELS COVER RED GREEN ORANGE BLUE | COUVRE-ROUES ROUGE VERT ORANGE BLEU | RADENKAPPE ROT GRÜN DUNKELORANGE BLAU |
| 18 | 82110007/3 82110008/2 82110016/2 | 1 | COPERTURA RUOTE (hydro) ROSSO VERDE ARANCIONE | WHEELS COVER (hydro) RED GREEN ORANGE | COUVRE-ROUES (hydro) ROUGE VERT ORANGE | RADENKAPPE (hydro) ROT GRÜN DUNKELORANGE |





| N. | CODE | Q.TY | DESCRIZIONE | DESCRIPTION | DESCRIPTION | BESCHREIBUNG |
|-----|------------|------|---------------------------|------------------------|---------------------------|-------------------------|
| | 82110010/2 | | BLU | BLUE | BLEU | BLAU |
| 19 | 25110264/1 | 1 | COPRIPEDANA DESTRA | RIGHT FOOTBOARDCOVER | COUVRE MARCHEPIED DRO. | RECHTE FUSSBRETTDECKEL |
| 20 | 25110263/1 | 1 | COPRIPEDANA SINISTRA | LEFT FOOTBOARD COVER | COUVRE MARCHEPIED GAU. | LINKE FUSSBRETTDECKEL |
| 21 | 12735410/0 | 6 | VITE | SCREW | VIS | SCHRAUBE |
| 22 | 12735402/0 | 4 | VITE | SCREW | VIS | SCHRAUBE |
| 23 | 12728680/0 | 1 | VITE | SCREW | VIS | SCHRAUBE |
| 24 | 12523040/0 | 5 | ROSETTA | WASHER | RONDELLE | SCHEIBE |
| 25 | 25730000/0 | 1 | SEPARATORE ASPIRAZ. (100) | INTAKE SEPARATOR (100) | SEPARATEUR ASPIRAT. (100) | AUGENABSCHIEDER (100) |
| 26 | 12523050/0 | 4 | ROSETTA | WASHER | RONDELLE | SCHEIBE |
| 31 | 82000207/0 | 1 | ACCELERATORE | ACCELERATOR | ACCELERATEUR | GAS ZUG |
| 32 | 12788512/0 | 2 | VITE | SCREW | VIS | SCHRAUBE |
| 33 | 12581200/0 | 2 | GROWER | GROWER | GROWER | GROWER |
| 34 | 25394501/0 | 1 | MANOPOLINA | HANDLE | POIGNE | GRIF |
| 35 | 12726388/0 | 1 | VITE | SCREW | VIS | SCHRAUBE |
| 36 | 12290800/0 | 1 | DADO | NUT | ECROU | MUTTER |
| 41 | 25722453/1 | 1 | SEDILE | SEAT | SIEGE | SITZ |
| 43 | 25547033/1 | 1 | PIASTRA | PLATE | PLAQUE | PLATTE |
| 44 | 12793101/0 | 4 | VITE | SCREW | VIS | SCHRAUBE |
| 45 | 12583500/0 | 4 | GROWER | GROWER | GROWER | GROWER |
| 46 | 12523060/0 | 4 | RONDELLA | WASHER | RONDELLE | SCHEIBE |
| 47 | 25430223/2 | 1 | MOLLA | SPRING | RESSORT | FEDER |
| 48 | 12789000/0 | 1 | VITE | SCREW | VIS | SCHRAUBE |
| 49 | 12154330/0 | 1 | DADO | NUT | ECROU | MUTTER |
| 51 | 25961201/0 | 1 | VOLANTE | STEERING WHEEL | VOLANT | LENKRAD |
| 52 | 12620299/0 | 1 | SPINA | PIN | GOUPILLE | STIFT |
| 53 | 25120230/0 | 1 | TAPPO | CAP | BOUCHON | STOPFEN |
| 54 | 27063021/1 | 1 | CAMMA | CAM | CAME | NOCKEN |
| 55 | 12789100/0 | 2 | VITE | SCREW | VIS | SCHRAUBE |
| 56 | 12523020/0 | 2 | RONDELLA | WASHER | RONDELLE | SCHEIBE |
| 57 | 12154330/0 | 2 | DADO | NUT | ECROU | MUTTER |
| 61 | • | 1 | COPERTURA | COVER | COUVRE | KAPPE |
| | 25110179/1 | | ROSSO | RED | ROUGE | ROT |
| | 25110199/1 | | VERDE | GREEN | VERT | GRÜN |
| | 25110127/2 | | ARANCIONE | ORANGE | ORANGE | DUNKELORANGE |
| | 25110201/1 | | BLU | BLUE | BLEU | BLAU |
| | 25110300/0 | | NERO | BLACK | NOIR | SCHWARZ |
| 62 | 25600033/0 | 1 | PROTEZIONE DESTRA, NERA | RIGHT GUARD, BLACK | PROTECTION DROITE, NOIR | RECHTE SCHUTZE, SCHWARZ |
| 63 | 25600034/0 | 1 | PROTEZIONE SINISTRA, NERA | LEFT GUARD, BLACK | PROTECTION GAUCHE, NOIR | LINKE SCHUTZE, SCHWARZ |
| 64 | 12735402/0 | 6 | VITE | SCREW | VIS | SCHRAUBE |
| 65 | 12734995/0 | 2 | VITE | SCREW | VIS | SCHRAUBE |
| 66 | 12735402/0 | 3 | VITE | SCREW | VIS | SCHRAUBE |
| 67 | 12735402/0 | 6 | VITE | SCREW | VIS | SCHRAUBE |
| 71 | • | 1 | COPERTURA SACCO | GRASS-CATCHER COVER | COUVRE-BAC | SACKKAPPE |
| | 25110178/2 | | ROSSO | RED | ROUGE | ROT |
| | 25110196/1 | | VERDE | GREEN | VERT | GRÜN |
| | 25110126/1 | | ARANCIONE | ORANGE | ORANGE | DUNKELORANGE |
| | 25110198/1 | | BLU | BLUE | BLEU | BLAU |
| | 25110299/0 | | NERO | BLACK | NOIR | SCHWARZ |
| 72 | 12729601/1 | 4 | VITE | SCREW | VIS | SCHRAUBE |
| 73 | 12521331/0 | 4 | RONDELLA | WASHER | RONDELLE | SCHEIBE |
| 81 | 25600020/0 | 1 | PROTEZIONE SUPERIORE | UPPER GUARD | PROTECTION SUPERIEUR | OBERSCHUTZ |
| 82 | 25600021/1 | 1 | PROTEZIONE INFERIORE | LOWER GUARD | PROTECTION INFERIEUR | UNTERSCHUTZ |
| 83 | 12728460/0 | 2 | VITE | SCREW | VIS | SCHRAUBE |
| 84 | 12521320/0 | 2 | ROSETTA | WASHER | RONDELLE | SCHEIBE |
| 85 | 12437502/0 | 2 | PIASTRINA | PLATE | PLAQUE | PLÄTTE |
| 91 | 25735116/2 | 1 | SERBATOIO | TANK | RESERVOIR | TANK |
| 92 | 25795000/2 | 1 | TAPPO | CAP | BOUCHON | TANKVERSCHLUSS |
| 93 | 25774258/0 | 1 | SUPPORTO | SUPPORT | SUPPORT | HALTER |
| 94 | 12735110/0 | 1 | VITE | SCREW | VIS | SCHRAUBE |
| 101 | 82869011/0 | 1 | PROTEZIONE SILENZIATORE | MUFFLER PROTECTION | PROTECTION SILENCIEUX | AUSPUFFSCHUTZ |
| 102 | 18566110/0 | 2 | PUNTALE | CAP | BOUCHON | PFROPFEN |
| 103 | 12734995/0 | 4 | VITE | SCREW | VIS | SCHRAUBE |
| 104 | 25547089/0 | 1 | PIASTRINA DESTRA | RIGHT PLATE | PLAQUE DROITE | RECHTE PLATTE |
| 105 | 25547091/0 | 1 | PIASTRINA SINISTRA | LEFT PLATE | PLAQUE GAUCHE | LINKE PLATTE |
| 106 | 12731580/0 | 4 | VITE | SCREW | VIS | SCHRAUBE |

J JP JT JR JTP JB JX

92

92 hydro

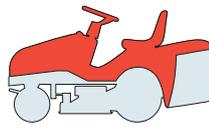

CARROZZERIA
BODY
CARROSSERIE
KARROSSERIE

2006

002c.0

1 / 2

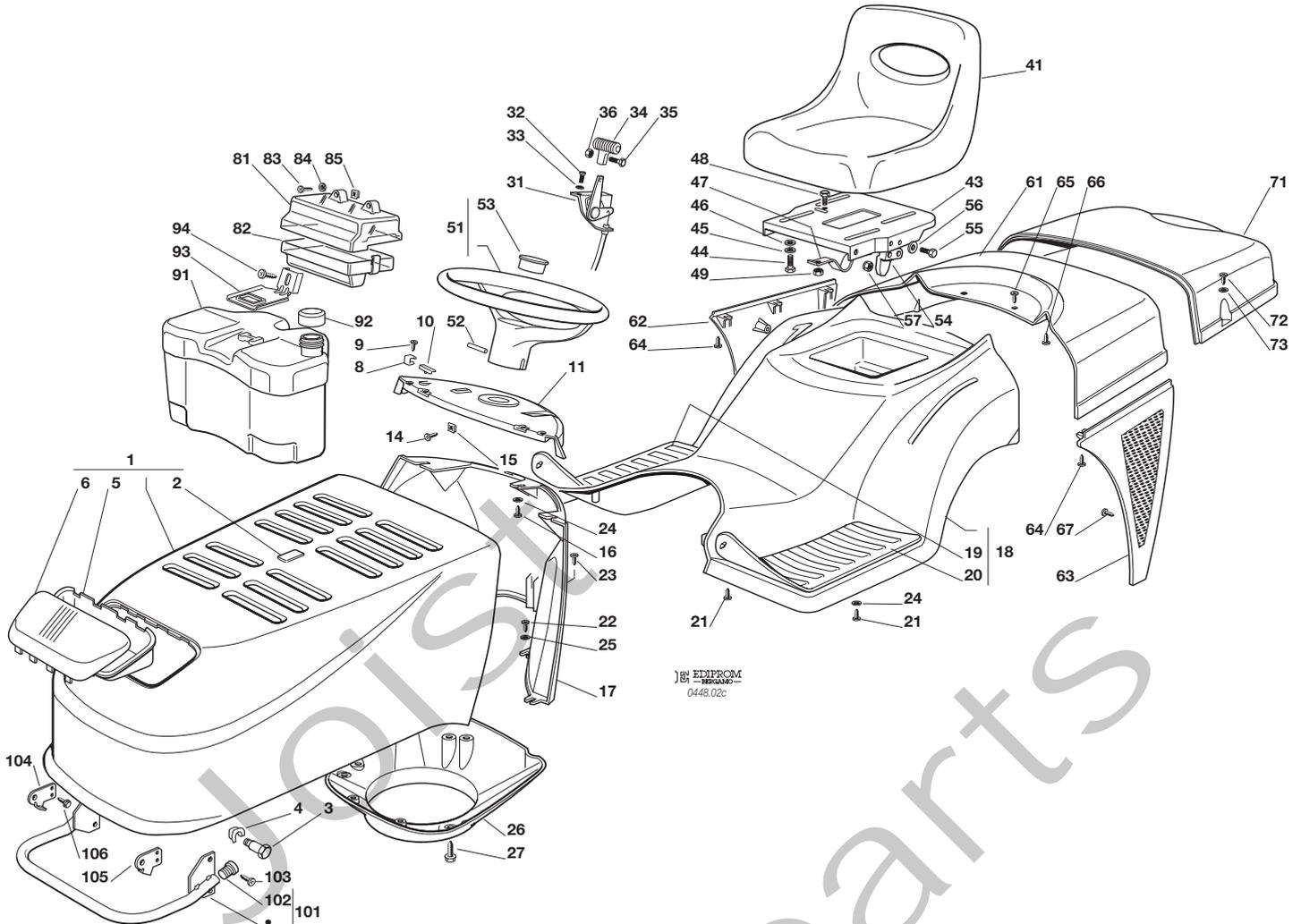

EPROM
0448,02c

| N. | CODE | Q.TY | DESCRIZIONE | DESCRIPTION | DESCRIPTION | BESCHREIBUNG |
|----|--------------------------|------|-------------------------------------------|--------------------------------------|---------------------------------------|-----------------------------------|
| 1 | 82076817/2 82076818/1 | 1 | COFANO ROSSO VERDE | ENGINE HOOD RED GREEN | CAPOT ROUGE VERT | HAUBESATZ ROT GRÜN |
| 2 | 25547016/2 25547015/0 | 1 | PIASTRINA ROSSA VERDE | PLATE RED GREEN | PLAQUE ROUGE VERT | PLATTE ROT GRÜN |
| 3 | 25510039/0 | 2 | PERNO | PIN | PIVOT | BOLZEN |
| 4 | 12436050/0 | 2 | PIASTRINA | PLATE | PLAQUE | PLATTE |
| 5 | 25485001/0 | 1 | PARABOLA FARI | LIGHTS PARABOLA | PARABOLE | SCHEINWERFERPARABEL |
| 6 | 25410865/0 | 1 | MASCHERINA | GRILL | PANNEAU | SCHUTZ |
| 8 | 25430215/0 | 2 | MOLLA AGGANCIO | COUPLING SPRING | RESSORT ACCROCHAGE | KUPPLUNGSFEDER |
| 9 | 12728450/0 | 2 | VITE | SCREW | VIS | SCHRAUBE |
| 10 | 25260000/0 | 2 | GOMMINO | GROMMET | PROTECTION | SCHUTZ |
| 11 | 25120151/0 | 1 | CRUSCOTTO | DASHBOARD | TABLEAU COMMANDES | KONSOLE |
| 14 | 12735110/0 | 2 | VITE | SCREW | VIS | SCHRAUBE |
| 15 | 12437502/0 | 2 | PIASTRINA | PLATE | PLAQUE | PLATTE |
| 16 | 12735402/0 | 3 | VITE | SCREW | VIS | SCHRAUBE |
| 17 | 25785062/2 | 1 | SUPPORTO CRUSCOTTO | DASHBOARD SUPPORT | SUPPORT TABLEAU COMM. | KONSOLEHALTER |
| 18 | 82110001/3 82110002/2 | 1 | COPERTURA RUOTE ROSSO VERDE | WHEELS COVER RED GREEN | COUVRE-ROUES ROUGE VERT | RADENKAPPE ROT GRÜN |
| 18 | 82110007/3 82110008/2 | 1 | COPERTURA RUOTE (hydro) ROSSO VERDE | WHEELS COVER (hydro) RED GREEN | COUVRE-ROUES (hydro) ROUGE VERT | RADENKAPPE (hydro) ROT GRÜN |
| 19 | 25110264/1 | 1 | COPRIPEDANA DESTRA | RIGHT FOOTBOARDCOVER | COUVRE MARCHEPIED DRO. | RECHTE FUSSBRETTDECKEL |
| 20 | 25110263/1 | 1 | COPRIPEDANA SINISTRA | LEFT FOOTBOARD COVER | COUVRE MARCHEPIED GAU. | LINKE FUSSBRETTDECKEL |
| 21 | 12735410/0 | 6 | VITE | SCREW | VIS | SCHRAUBE |
| 22 | 12735402/0 | 4 | VITE | SCREW | VIS | SCHRAUBE |
| 23 | 12728680/0 | 1 | VITE | SCREW | VIS | SCHRAUBE |
| 24 | 12523040/0 | 5 | ROSETTA | WASHER | RONDELLE | SCHEIBE |
| 25 | 12523050/0 | 4 | ROSETTA | WASHER | RONDELLE | SCHEIBE |





| N. | CODE | Q.TY | DESCRIZIONE | DESCRIPTION | DESCRIPTION | BESCHREIBUNG |
|-----|------------|------|---------------------------|----------------------------|-------------------------|-------------------------|
| 26 | 25108028/0 | 1 | CONVOGLIATORE (12) | CONVEYOR (12) | CONVOYEUR (12) | KONVEYOR (12) |
| 27 | 12728686/0 | 3 | VITE | SCREW | VIS | SCHRAUBE |
| 31 | 82000207/0 | 1 | ACCELERATORE | ACCELERATOR | ACCELERATEUR | GAS ZUG |
| 32 | 12788512/0 | 2 | VITE | SCREW | VIS | SCHRAUBE |
| 33 | 12581200/0 | 2 | GROWER | GROWER | GROWER | GROWER |
| 34 | 25394501/0 | 1 | MANOPOLINA | HANDLE | POIGNE | GRIFF |
| 35 | 12726388/0 | 1 | VITE | SCREW | VIS | SCHRAUBE |
| 36 | 12290800/0 | 1 | DADO | NUT | ECROU | MUTTER |
| 41 | 25722453/1 | 1 | SEDILE | SEAT | SIEGE | SITZ |
| 43 | 25547033/1 | 1 | PIASTRA | PLATE | PLAQUE | PLATTE |
| 44 | 12793101/0 | 4 | VITE | SCREW | VIS | SCHRAUBE |
| 45 | 12583500/0 | 4 | GROWER | GROWER | GROWER | GROWER |
| 46 | 12523060/0 | 4 | RONDELLA | WASHER | RONDELLE | SCHEIBE |
| 47 | 25430223/2 | 1 | MOLLA | SPRING | RESSORT | FEDER |
| 48 | 12789000/0 | 1 | VITE | SCREW | VIS | SCHRAUBE |
| 49 | 12154330/0 | 1 | DADO | NUT | ECROU | MUTTER |
| 51 | 25961201/0 | 1 | VOLANTE | STEERING WHEEL | VOLANT | LENKRAD |
| 52 | 12620299/0 | 1 | SPINA | PIN | GOUPILLE | STIFT |
| 53 | 25120230/0 | 1 | TAPPO | CAP | BOUCHON | STOPFEN |
| 54 | 27063021/1 | 1 | CAMMA | CAM | CAME | NOCKEN |
| 55 | 12789100/0 | 2 | VITE | SCREW | VIS | SCHRAUBE |
| 56 | 12523020/0 | 2 | RONDELLA | WASHER | RONDELLE | SCHEIBE |
| 57 | 12154330/0 | 2 | DADO | NUT | ECROU | MUTTER |
| 61 | 25110179/1 | 1 | COPERTURA ROSSO | COVER RED | COUVRE ROUGE | KAPPE ROT |
| | 25110199/1 | | VERDE | GREEN | VERT | GRÜN |
| | 25110300/0 | | NERO | BLACK | NOIR | SCHWARZ |
| 62 | 25600033/0 | 1 | PROTEZIONE DESTRA, NERA | RIGHT GUARD, BLACK | PROTECTION DROITE, NOIR | RECHTE SCHUTZE, SCHWARZ |
| 63 | 25600034/0 | 1 | PROTEZIONE SINISTRA, NERA | LEFT GUARD, BLACK | PROTECTION GAUCHE, NOIR | LINKE SCHUTZE, SCHWARZ |
| 64 | 12735402/0 | 6 | VITE | SCREW | VIS | SCHRAUBE |
| 65 | 12734995/0 | 2 | VITE | SCREW | VIS | SCHRAUBE |
| 66 | 12735402/0 | 3 | VITE | SCREW | VIS | SCHRAUBE |
| 67 | 12735402/0 | 6 | VITE | SCREW | VIS | SCHRAUBE |
| 71 | 25110178/2 | 1 | COPERTURA SACCO ROSSO | GRASS-CATCHER COVER RED | COUVRE-BAC ROUGE | SACKKAPPE ROT |
| | 25110196/1 | | VERDE | GREEN | VERT | GRÜN |
| | 25110299/0 | | NERO | BLACK | NOIR | SCHWARZ |
| 72 | 12729601/1 | 4 | VITE | SCREW | VIS | SCHRAUBE |
| 73 | 12521331/0 | 4 | RONDELLA | WASHER | RONDELLE | SCHEIBE |
| 81 | 25600020/0 | 1 | PROTEZIONE SUPERIORE | UPPER GUARD | PROTECTION SUPERIEUR | OBERSCHUTZ |
| 82 | 25600021/1 | 1 | PROTEZIONE INFERIORE | LOWER GUARD | PROTECTION INFERIEUR | UNTERSCHUTZ |
| 83 | 12728460/0 | 2 | VITE | SCREW | VIS | SCHRAUBE |
| 84 | 12521320/0 | 2 | ROSETTA | WASHER | RONDELLE | SCHEIBE |
| 85 | 12437502/0 | 2 | PIASTRINA | PLATE | PLAQUE | PLÄTTE |
| 91 | 25735116/2 | 1 | SERBATOIO | TANK | RESERVOIR | TANK |
| 92 | 25795000/1 | 1 | TAPPO | CAP | BOUCHON | TANKVERSCHLUSS |
| 93 | 25774258/0 | 1 | SUPPORTO | SUPPORT | SUPPORT | HALTER |
| 94 | 12735110/0 | 1 | VITE | SCREW | VIS | SCHRAUBE |
| 101 | 82869011/0 | 1 | PROTEZIONE SILENZIATORE | MUFFLER PROTECTION | PROTECTION SILENCIEUX | AUSPUFFSCHUTZ |
| 102 | 18566110/0 | 2 | PUNTALE | CAP | BOUCHON | PFRÖPFEN |
| 103 | 12734995/0 | 4 | VITE | SCREW | VIS | SCHRAUBE |
| 104 | 25547089/0 | 1 | PIASTRINA DESTRA | RIGHT PLATE | PLAQUE DROITE | RECHTE PLATTE |
| 105 | 25547091/0 | 1 | PIASTRINA SINISTRA | LEFT PLATE | PLAQUE GAUCHE | LINKE PLATTE |
| 106 | 12731580/0 | 4 | VITE | SCREW | VIS | SCHRAUBE |

J JP JT JR JTP JB JX

92

92 hydro

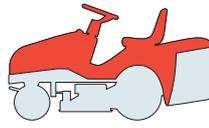

CARROZZERIA
BODY
CARROSSERIE
KARROSSERIE

2006

002d.0

1 / 2

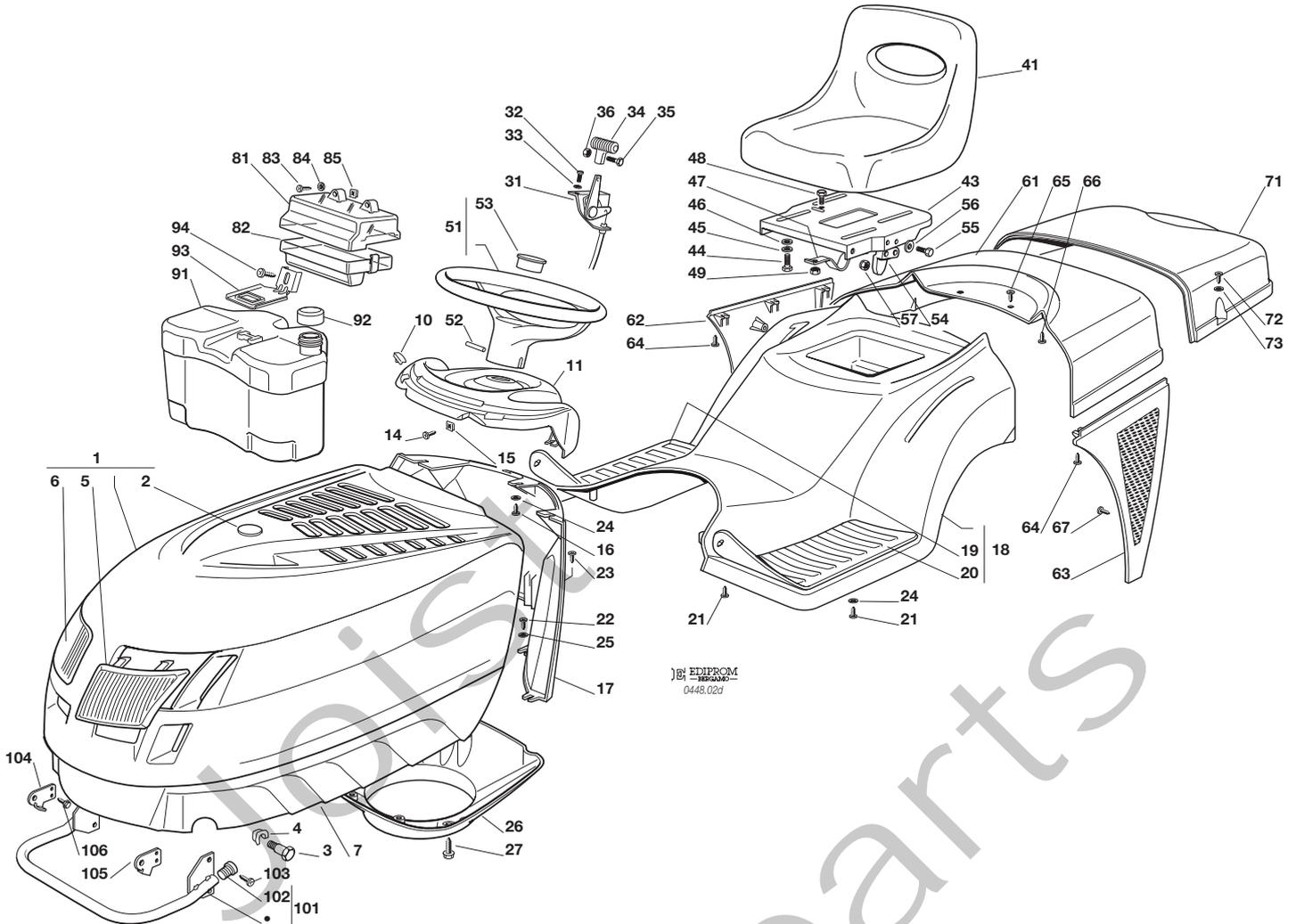

| N. | CODE | Q.TY | DESCRIZIONE | DESCRIPTION | DESCRIPTION | BESCHREIBUNG |
|----|----------------------------------------|------|--------------------------------------------------|----------------------------------------------|-----------------------------------------------|-------------------------------------------|
| 1 | 82076841/3 82076843/2 82076847/2 | 1 | COFANO SUPERIORE ROSSO VERDE BLU | UPPER ENGINE HOOD RED GREEN BLUE | CAPOT SUPERIEURE ROUGE VERT BLEU | OBERHAUBESATZ ROT GRÜN BLAU |
| 2 | 25547025/1 25547026/0 25547028/0 | 1 | PIASTRINA ROSSA VERDE BLU | PLATE RED GREEN BLUE | PLAQUE ROUGE VERT BLEU | PLATTE ROT GRÜN BLAU |
| 3 | 25510023/1 | 2 | PERNO | PIN | PIVOT | BOLZEN |
| 4 | 12436050/0 | 2 | PIASTRINA | PLATE | PLAQUE | PLATTE |
| 5 | 25410861/0 | 1 | MASCHERINA SINISTRA | LEFT GRILL | PANNEAU GAUCHE | LINKE SCHUTZ |
| 6 | 25410860/0 | 1 | MASCHERINA DESTRA | RIGHT GRILL | PANNEAU DROITE | RECHTE SCHUTZ |
| 7 | 25076808/0 | 1 | COFANO INFERIORE | LOWER ENGINE HOOD | CAPOT INFERIEURE | UNTERHAUBESATZ |
| 10 | 25260000/0 | 2 | GOMMINO | GROMMET | PROTECTION | SCHUTZ |
| 11 | 25120179/0 | 1 | CRUSCOTTO | DASHBOARD | TABLEAU COMMANDES | KONSOLE |
| 14 | 12735110/0 | 2 | VITE | SCREW | VIS | SCHRAUBE |
| 15 | 12437502/0 | 2 | PIASTRINA | PLATE | PLAQUE | PLATTE |
| 16 | 12735402/0 | 3 | VITE | SCREW | VIS | SCHRAUBE |
| 17 | 25785053/1 | 1 | SUPPORTO CRUSCOTTO | DASHBOARD SUPPORT | SUPPORT TABLEAU COMM. | KONSOLEHALTER |
| 18 | 82110001/3 82110002/2 82110004/2 | 1 | COPERTURA RUOTE ROSSO VERDE BLU | WHEELS COVER RED GREEN BLUE | COUVRE-ROUES ROUGE VERT BLEU | RADENKAPPE ROT GRÜN BLAU |
| 18 | 82110007/3 82110008/2 82110010/2 | 1 | COPERTURA RUOTE (hydro) ROSSO VERDE BLU | WHEELS COVER (hydro) RED GREEN BLUE | COUVRE-ROUES (hydro) ROUGE VERT BLEU | RADENKAPPE (hydro) ROT GRÜN BLAU |
| 19 | 25110264/1 | 1 | COPRIPEDANA DESTRA | RIGHT FOOTBOARDCOVER | COUVRE MARCHEPIED DRO. | RECHTE FUSSBRETTDECKEL |
| 20 | 25110263/1 | 1 | COPRIPEDANA SINISTRA | LEFT FOOTBOARD COVER | COUVRE MARCHEPIED GAU. | LINKE FUSSBRETTDECKEL |
| 21 | 12735410/0 | 6 | VITE | SCREW | VIS | SCHRAUBE |
| 22 | 12735402/0 | 4 | VITE | SCREW | VIS | SCHRAUBE |





| N. | CODE | Q.TY | DESCRIZIONE | DESCRIPTION | DESCRIPTION | BESCHREIBUNG |
|-----|------------|------|---------------------------|---------------------|-------------------------|-------------------------|
| 23 | 12728680/0 | 1 | VITE | SCREW | VIS | SCHRAUBE |
| 24 | 12523040/0 | 5 | ROSETTA | WASHER | RONDELLE | SCHEIBE |
| 25 | 12523050/0 | 4 | ROSETTA | WASHER | RONDELLE | SCHEIBE |
| 26 | 25108024/0 | 1 | CONVOGLIATORE (4) | CONVEYOR (4) | CONVOYEUR (4) | KONVEYOR (4) |
| | 25108028/0 | 1 | CONVOGLIATORE (126) | CONVEYOR (126) | CONVOYEUR (126) | KONVEYOR (126) |
| 27 | 12728686/0 | 3 | VITE | SCREW | VIS | SCHRAUBE |
| 31 | 82000207/0 | 1 | ACCELERATORE | ACCELERATOR | ACCELERATEUR | GAS ZUG |
| 32 | 12788512/0 | 2 | VITE | SCREW | VIS | SCHRAUBE |
| 33 | 12581200/0 | 2 | GROWER | GROWER | GROWER | GROWER |
| 34 | 25394501/0 | 1 | MANOPOLINA | HANDLE | POIGNE | GRIFF |
| 35 | 12726388/0 | 1 | VITE | SCREW | VIS | SCHRAUBE |
| 36 | 12290800/0 | 1 | DADO | NUT | ECROU | MUTTER |
| 41 | 25722453/1 | 1 | SEDILE | SEAT | SIEGE | SITZ |
| 43 | 25547033/1 | 1 | PIASTRA | PLATE | PLAQUE | PLATTE |
| 44 | 12793101/0 | 4 | VITE | SCREW | VIS | SCHRAUBE |
| 45 | 12583500/0 | 4 | GROWER | GROWER | GROWER | GROWER |
| 46 | 12523060/0 | 4 | RONDELLA | WASHER | RONDELLE | SCHEIBE |
| 47 | 25430223/2 | 1 | MOLLA | SPRING | RESSORT | FEDER |
| 48 | 12789000/0 | 1 | VITE | SCREW | VIS | SCHRAUBE |
| 49 | 12154330/0 | 1 | DADO | NUT | ECROU | MUTTER |
| 51 | 25961201/0 | 1 | VOLANTE | STEERING WHEEL | VOLANT | LENKRAD |
| 52 | 12620299/0 | 1 | SPINA | PIN | GOUPILLE | STIFT |
| 53 | 25120230/0 | 1 | TAPPO | CAP | BOUCHON | STOPFEN |
| 54 | 27063021/1 | 1 | CAMMA | CAM | CAME | NOCKEN |
| 55 | 12789100/0 | 2 | VITE | SCREW | VIS | SCHRAUBE |
| 56 | 12523020/0 | 2 | RONDELLA | WASHER | RONDELLE | SCHEIBE |
| 57 | 12154330/0 | 2 | DADO | NUT | ECROU | MUTTER |
| 61 | • | 1 | COPERTURA | COVER | COUVRE | KAPPE |
| | 25110179/1 | | ROSSO | RED | ROUGE | ROT |
| | 25110199/1 | | VERDE | GREEN | VERT | GRÜN |
| | 25110201/1 | | BLU | BLUE | BLEU | SCHWARZ |
| | 25110300/0 | | NERO | BLACK | NOIR | SCHWARZ |
| 62 | 25600033/0 | 1 | PROTEZIONE DESTRA, NERA | RIGHT GUARD, BLACK | PROTECTION DROITE, NOIR | RECHTE SCHUTZE, SCHWARZ |
| 63 | 25600034/0 | 1 | PROTEZIONE SINISTRA, NERA | LEFT GUARD, BLACK | PROTECTION GAUCHE, NOIR | LINKE SCHUTZE, SCHWARZ |
| 64 | 12735402/0 | 6 | VITE | SCREW | VIS | SCHRAUBE |
| 65 | 12734995/0 | 2 | VITE | SCREW | VIS | SCHRAUBE |
| 66 | 12735402/0 | 3 | VITE | SCREW | VIS | SCHRAUBE |
| 67 | 12735402/0 | 6 | VITE | SCREW | VIS | SCHRAUBE |
| 71 | • | 1 | COPERTURA SACCO | GRASS-CATCHER COVER | COUVRE-BAC | SACKKAPPE |
| | 25110178/2 | | ROSSO | RED | ROUGE | ROT |
| | 25110196/1 | | VERDE | GREEN | VERT | GRÜN |
| | 25110198/1 | | BLU | BLUE | BLEU | BLAU |
| | 25110299/0 | | NERO | BLACK | NOIR | SCHWARZ |
| 72 | 12729601/1 | 4 | VITE | SCREW | VIS | SCHRAUBE |
| 73 | 12521331/0 | 4 | RONDELLA | WASHER | RONDELLE | SCHEIBE |
| 81 | 25600020/0 | 1 | PROTEZIONE SUPERIORE | UPPER GUARD | PROTECTION SUPERIEUR | OBERSCHUTZ |
| 82 | 25600021/1 | 1 | PROTEZIONE INFERIORE | LOWER GUARD | PROTECTION INFERIEUR | UNTERSCHUTZ |
| 83 | 12728460/0 | 2 | VITE | SCREW | VIS | SCHRAUBE |
| 84 | 12521320/0 | 2 | ROSETTA | WASHER | RONDELLE | SCHEIBE |
| 85 | 12437502/0 | 2 | PIASTRINA | PLATE | PLAQUE | PLATTE |
| 91 | 25735116/2 | 1 | SERBATOIO | TANK | RESERVOIR | TANK |
| 92 | 25795000/1 | 1 | TAPPO | CAP | BOUCHON | TANKVERSCHLUSS |
| 93 | 25774258/0 | 1 | SUPPORTO | SUPPORT | SUPPORT | HALTER |
| 94 | 12735110/0 | 1 | VITE | SCREW | VIS | SCHRAUBE |
| 101 | 82869006/1 | 1 | PROTEZIONE SILENZIATORE | MUFFLER PROTECTION | PROTECTION SILENCIEUX | AUSPUFFSCHUTZ |
| 102 | 18566110/0 | 2 | PUNTALE | CAP | BOUCHON | PFROPFEN |
| 103 | 12734995/0 | 4 | VITE | SCREW | VIS | SCHRAUBE |
| 104 | 25547089/0 | 1 | PIASTRINA DESTRA | RIGHT PLATE | PLAQUE DROITE | RECHTE PLATTE |
| 105 | 25547091/0 | 1 | PIASTRINA SINISTRA | LEFT PLATE | PLAQUE GAUCHE | LINKE PLATTE |
| 106 | 12731580/0 | 4 | VITE | SCREW | VIS | SCHRAUBE |

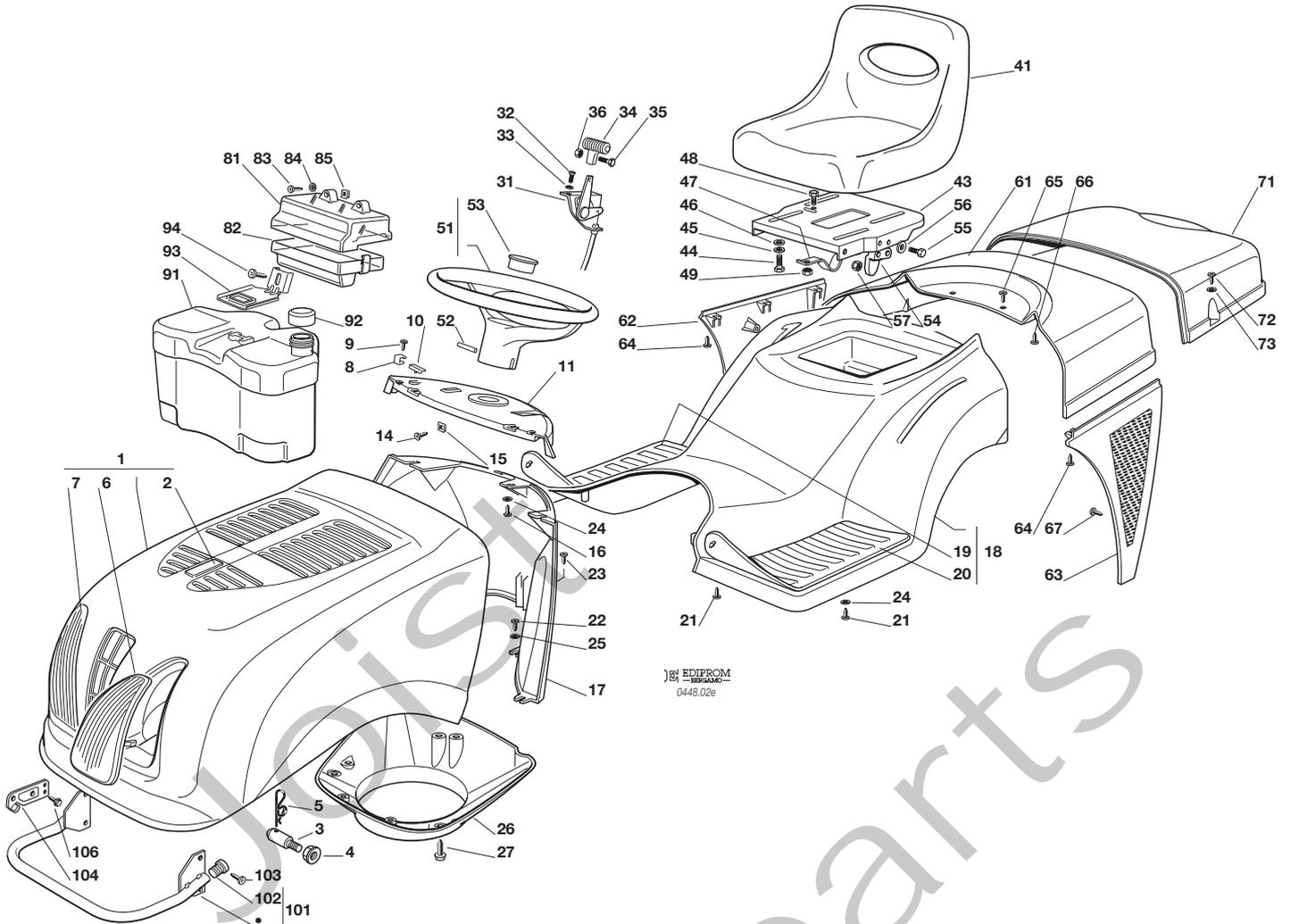
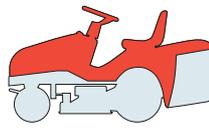

EDIPROM
0448.02e

| N. | CODE | Q.TY | DESCRIZIONE | DESCRIPTION | DESCRIPTION | BESCHREIBUNG |
|----|------------|------|--------------------------|----------------------|------------------------|------------------------|
| 1 | 82076917/1 | 1 | COFANO ROSSO | ENGINE HOOD RED | CAPOT ROUGE | HAUBESATZ ROT |
| | 82076918/0 | | VERDE | GREEN | VERT | GRÜN |
| | 82076919/0 | | BLU | BLUE | BLEU | BLAU |
| 2 | 25547016/2 | 1 | PIASTRINA ROSSA | PLATE RED | PLAQUE ROUGE | PLATTE ROT |
| | 25547015/0 | | VERDE | GREEN | VERT | GRÜN |
| | 25547024/0 | | BLU | BLUE | BLEU | BLAU |
| 3 | 25510068/0 | 2 | PERNO | PIN | PIVOT | BOLZEN |
| 4 | 12293201/0 | 2 | DADO | NUT | ECROU | MUTTER |
| 5 | 24487998/0 | 1 | COPPIGLIA | COTTER PIN | GOUPILLE | SPLIT |
| 6 | 25410869/0 | 1 | MASCHERINA SINISTRA | LEFT GRILL | PANNEAU GAUCHE | LINKE SCHUTZ |
| 7 | 25410868/0 | 1 | MASCHERINA DESTRA | RIGHT GRILL | PANNEAU DROITE | RECHTE SCHUTZ |
| 8 | 25430215/0 | 2 | MOLLA AGGANCIO | COUPLING SPRING | RESSORT ACCROCHAGE | KUPPLUNGSFEDER |
| 9 | 12728450/0 | 2 | VITE | SCREW | VIS | SCHRAUBE |
| 10 | 25260000/0 | 2 | GOMMINO | GROMMET | PROTECTION | SCHUTZ |
| 11 | 25120151/0 | 1 | CRUSCOTTO | DASHBOARD | TABEUAU COMMANDES | KONSOLE |
| 14 | 12735110/0 | 2 | VITE | SCREW | VIS | SCHRAUBE |
| 15 | 12437502/0 | 2 | PIASTRINA | PLATE | PLAQUE | PLATTE |
| 16 | 12735402/0 | 3 | VITE | SCREW | VIS | SCHRAUBE |
| 17 | 25785053/1 | 1 | SUPPORTO CRUSCOTTO | DASHBOARD SUPPORT | SUPPORT TABLEAU COMM. | KONSOLEHALTER |
| 18 | 82110001/3 | 1 | COPERTURA RUOTE ROSSO | WHEELS COVER RED | COUVRE-ROUES ROUGE | RADENKAPPE ROT |
| | 82110002/2 | | VERDE | GREEN | VERT | GRÜN |
| | 82110004/2 | | BLU | BLUE | BLEU | BLAU |
| 18 | 82110007/3 | 1 | COPERTURA RUOTE (hydro) | WHEELS COVER (hydro) | COUVRE-ROUES (hydro) | RADENKAPPE (hydro) |
| | 82110008/2 | | ROSSO | RED | ROUGE | ROT |
| | 82110010/2 | | VERDE | GREEN | VERT | GRÜN |
| | 82110010/2 | | BLU | BLUE | BLEU | BLAU |
| 19 | 25110264/1 | 1 | COPRIPEDANA DESTRA | RIGHT FOOTBOARDCOVER | COUVRE MARCHEPIED DRO. | RECHTE FUSSBRETTDECKEL |
| 20 | 25110263/1 | 1 | COPRIPEDANA SINISTRA | LEFT FOOTBOARD COVER | COUVRE MARCHEPIED GAU. | LINKE FUSSBRETTDECKEL |





| N. | CODE | Q.TY | DESCRIZIONE | DESCRIPTION | DESCRIPTION | BESCHREIBUNG |
|-----|------------|------|---------------------------|---------------------|-------------------------|-------------------------|
| 21 | 12735410/0 | 6 | VITE | SCREW | VIS | SCHRAUBE |
| 22 | 12735402/0 | 4 | VITE | SCREW | VIS | SCHRAUBE |
| 23 | 12728680/0 | 1 | VITE | SCREW | VIS | SCHRAUBE |
| 24 | 12523040/0 | 5 | ROSETTA | WASHER | RONDELLE | SCHEIBE |
| 25 | 12523050/0 | 4 | ROSETTA | WASHER | RONDELLE | SCHEIBE |
| 26 | 25108024/0 | 1 | CONVOGLIATORE (4) | CONVEYOR (4) | CONVOYEUR (4) | KONVEYOR (4) |
| | 25108028/0 | 1 | CONVOGLIATORE (126) | CONVEYOR (126) | CONVOYEUR (126) | KONVEYOR (126) |
| 27 | 12728686/0 | 3 | VITE | SCREW | VIS | SCHRAUBE |
| 31 | 82000207/0 | 1 | ACCELERATORE | ACCELERATOR | ACCELERATEUR | GAS ZUG |
| 32 | 12788512/0 | 2 | VITE | SCREW | VIS | SCHRAUBE |
| 33 | 12581200/0 | 2 | GROWER | GROWER | GROWER | GROWER |
| 34 | 25394501/0 | 1 | MANOPOLINA | HANDLE | POIGNE | GRIFF |
| 35 | 12726388/0 | 1 | VITE | SCREW | VIS | SCHRAUBE |
| 36 | 12290800/0 | 1 | DADO | NUT | ECROU | MUTTER |
| 41 | 25722453/1 | 1 | SEDILE | SEAT | SIEGE | SITZ |
| 43 | 25547033/1 | 1 | PIASTRA | PLATE | PLAQUE | PLATTE |
| 44 | 12793101/0 | 4 | VITE | SCREW | VIS | SCHRAUBE |
| 45 | 12583500/0 | 4 | GROWER | GROWER | GROWER | GROWER |
| 46 | 12523060/0 | 4 | RONDELLA | WASHER | RONDELLE | SCHEIBE |
| 47 | 25430223/2 | 1 | MOLLA | SPRING | RESSORT | FEDER |
| 48 | 12789000/0 | 1 | VITE | SCREW | VIS | SCHRAUBE |
| 49 | 12154330/0 | 1 | DADO | NUT | ECROU | MUTTER |
| 51 | 25961201/0 | 1 | VOLANTE | STEERING WHEEL | VOLANT | LENKRAD |
| 52 | 12620299/0 | 1 | SPINA | PIN | GOUPILLE | STIFT |
| 53 | 25120230/0 | 1 | TAPPO | CAP | BOUCHON | STOPFEN |
| 54 | 27063021/1 | 1 | CAMMA | CAM | CAME | NOCKEN |
| 55 | 12789100/0 | 2 | VITE | SCREW | VIS | SCHRAUBE |
| 56 | 12523020/0 | 2 | RONDELLA | WASHER | RONDELLE | SCHEIBE |
| 57 | 12154330/0 | 2 | DADO | NUT | ECROU | MUTTER |
| 61 | • | 1 | COPERTURA | COVER | COUVRE | KAPPE |
| | 25110179/1 | | ROSSO | RED | ROUGE | ROT |
| | 25110199/1 | | VERDE | GREEN | VERT | GRÜN |
| | 25110201/1 | | BLU | BLUE | BLEU | BLAU |
| | 25110300/0 | | NERO | BLACK | NOIR | SCHWARZ |
| 62 | 25600033/0 | 1 | PROTEZIONE DESTRA, NERA | RIGHT GUARD, BLACK | PROTECTION DROITE, NOIR | RECHTE SCHUTZE, SCHWARZ |
| 63 | 25600034/0 | 1 | PROTEZIONE SINISTRA, NERA | LEFT GUARD, BLACK | PROTECTION GAUCHE, NOIR | LINKE SCHUTZE, SCHWARZ |
| 64 | 12735402/0 | 6 | VITE | SCREW | VIS | SCHRAUBE |
| 65 | 12734995/0 | 2 | VITE | SCREW | VIS | SCHRAUBE |
| 66 | 12735402/0 | 3 | VITE | SCREW | VIS | SCHRAUBE |
| 67 | 12735402/0 | 6 | VITE | SCREW | VIS | SCHRAUBE |
| 71 | • | 1 | COPERTURA SACCO | GRASS-CATCHER COVER | COUVRE-BAC | SACKKAPPE |
| | 25110178/2 | | ROSSO | RED | ROUGE | ROT |
| | 25110196/1 | | VERDE | GREEN | VERT | GRÜN |
| | 25110198/1 | | BLU | BLUE | BLEU | BLAU |
| | 25110299/0 | | NERO | BLACK | NOIR | SCHWARZ |
| 72 | 12729601/1 | 4 | VITE | SCREW | VIS | SCHRAUBE |
| 73 | 12521331/0 | 4 | RONDELLA | WASHER | RONDELLE | SCHEIBE |
| 81 | 25600020/0 | 1 | PROTEZIONE SUPERIORE | UPPER GUARD | PROTECTION SUPERIEUR | OBERSCHUTZ |
| 82 | 25600021/1 | 1 | PROTEZIONE INFERIORE | LOWER GUARD | PROTECTION INFERIEUR | UNTERSCHUTZ |
| 83 | 12728460/0 | 2 | VITE | SCREW | VIS | SCHRAUBE |
| 84 | 12521320/0 | 2 | ROSETTA | WASHER | RONDELLE | SCHEIBE |
| 85 | 12437502/0 | 2 | PIASTRINA | PLATE | PLAQUE | PLÄTTE |
| 91 | 25735116/2 | 1 | SERBATOIO | TANK | RESERVOIR | TANK |
| 92 | 25795000/1 | 1 | TAPPO | CAP | BOUCHON | TANKVERSCHLUSS |
| 93 | 25774258/0 | 1 | SUPPORTO | SUPPORT | SUPPORT | HALTER |
| 94 | 12735110/0 | 1 | VITE | SCREW | VIS | SCHRAUBE |
| 101 | 82869011/0 | 1 | PROTEZIONE SILENZIATORE | MUFFLER PROTECTION | PROTECTION SILENCIEUX | AUSPUFFSCHUTZ |
| 102 | 18566110/0 | 2 | PUNTALE | CAP | BOUCHON | PFROPFEN |
| 103 | 12734995/0 | 4 | VITE | SCREW | VIS | SCHRAUBE |
| 104 | 25547109/1 | 2 | PIASTRINA | PLATE | PLAQUE | PLATTE |
| 106 | 12731580/0 | 4 | VITE | SCREW | VIS | SCHRAUBE |

J JP JT JR JTP JB JX

92

92 hydro

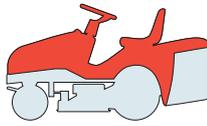

CARROZZERIA
BODY
CARROSSERIE
KARROSSERIE

2006

002f.0

1 / 2

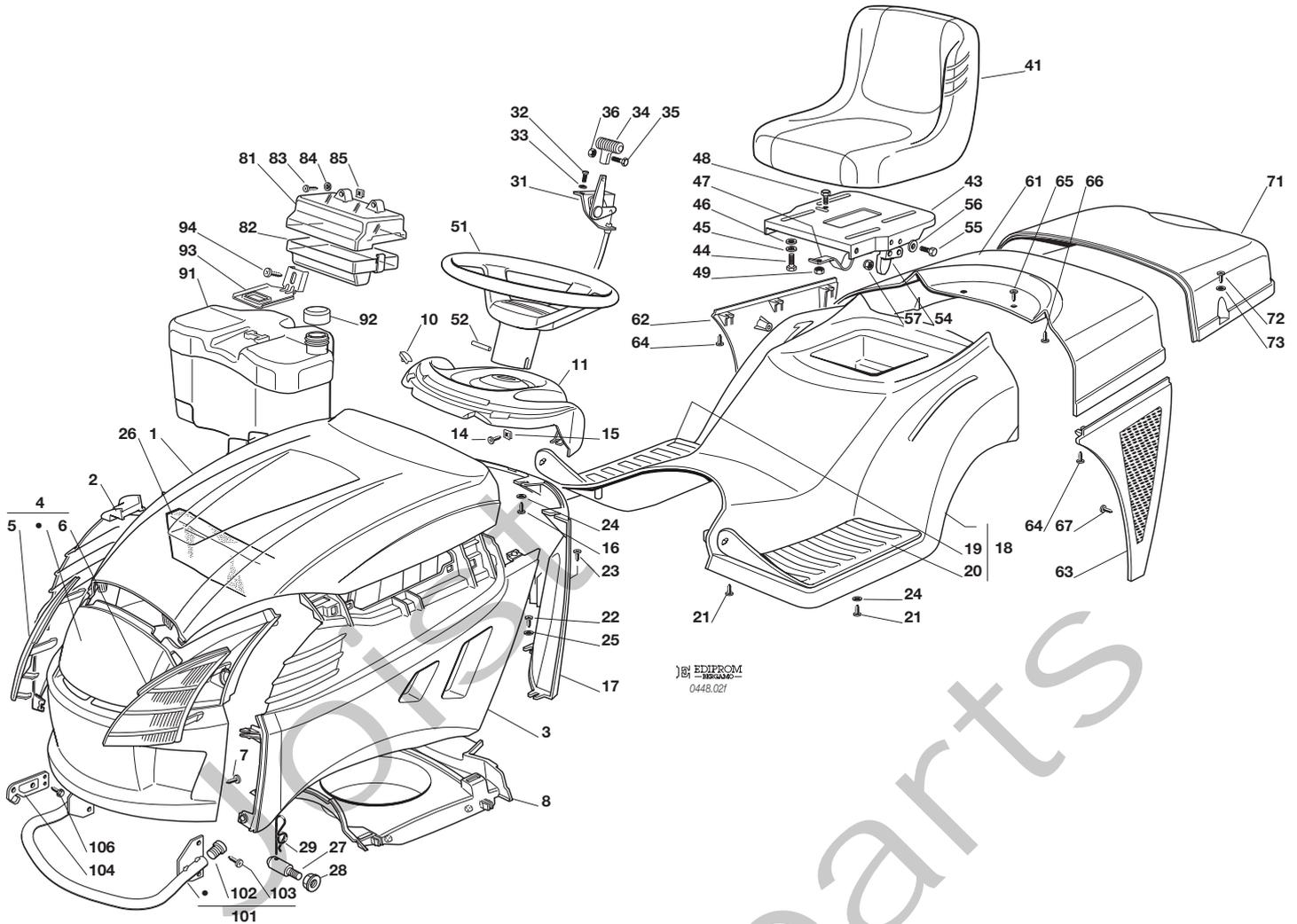

| N. | CODE | Q.TY | DESCRIZIONE | DESCRIPTION | DESCRIPTION | BESCHREIBUNG |
|----|------------|------|-------------------------|-----------------------|------------------------|------------------------|
| 1 | 25076858/0 | 1 | COFANO SUPERIORE | UPPER ENGINE HOOD | CAPOT SUPERIEURE | OBERHAUBESATZ |
| 2 | 25207120/0 | 1 | COFANO DX | HOOD, RIGHT | CAPOT DROITE | RECHTE HAUBE |
| 3 | 25207121/0 | 1 | COFANO SX | HOOD, LEFT | CAPOT GAUCHE | LINKE HAUBE |
| 4 | 82394607/0 | 1 | COFANO FRONTALE | HOOD, FRONT | CAPOT AVANT | VORDE HAUBE |
| 5 | 25410874/0 | 1 | MASCHERINA DESTRA | RIGHT GRILL | PANNEAU DROITE | RECHTE SCHUTZ |
| 6 | 25410875/0 | 1 | MASCHERINA SINISTRA | LEFT GRILL | PANNEAU GAUCHE | LINKE SCHUTZ |
| 7 | 12735405/0 | 6 | VITE | SCREW | VIS | SCHRAUBE |
| 8 | 25108025/0 | 1 | CONVOGLIATORE (4) | CONVEYOR (4) | CONVOYEUR (4) | KONVEYOR (4) |
| 10 | 25260000/0 | 2 | GOMMINO | GROMMET | PROTECTION | SCHUTZ |
| 11 | 25120179/0 | 1 | CRUSCOTTO | DASHBOARD | TABLEAU COMMANDES | KONSOLE |
| 14 | 12735110/0 | 2 | VITE | SCREW | VIS | SCHRAUBE |
| 15 | 12437502/0 | 2 | PIASTRINA | PLATE | PLAQUE | PLATTE |
| 16 | 12735402/0 | 3 | VITE | SCREW | VIS | SCHRAUBE |
| 17 | 25785053/1 | 1 | SUPPORTO CRUSCOTTO | DASHBOARD SUPPORT | SUPPORT TABLEAU COMM. | KONSOLEHALTER |
| 18 | 82110001/3 | 1 | COPERTURA RUOTE | WHEELS COVER | COUVRE-ROUES | RADENKAPPE |
| 18 | 82110007/3 | 1 | COPERTURA RUOTE (hydro) | WHEELS COVER (hydro) | COUVRE-ROUES (hydro) | RADENKAPPE (hydro) |
| 19 | 25110264/1 | 1 | COPRIPEDANA DESTRA | RIGHT FOOTBOARD COVER | COUVRE MARCHEPIED DRO. | RECHTE FUSSBRETTDECKEL |
| 20 | 25110263/1 | 1 | COPRIPEDANA SINISTRA | LEFT FOOTBOARD COVER | COUVRE MARCHEPIED GAU. | LINKE FUSSBRETTDECKEL |
| 21 | 12735410/0 | 6 | VITE | SCREW | VIS | SCHRAUBE |
| 22 | 12735402/0 | 4 | VITE | SCREW | VIS | SCHRAUBE |
| 23 | 12728680/0 | 1 | VITE | SCREW | VIS | SCHRAUBE |
| 24 | 12523040/0 | 5 | ROSETTA | WASHER | RONDELLE | SCHEIBE |
| 25 | 12523050/0 | 4 | ROSETTA | WASHER | RONDELLE | SCHEIBE |
| 26 | 25730016/0 | 1 | SEPARATORE ASPIR. (4) | INTAKE SEPARATOR (4) | SEPARATEUR ASPIR. (4) | AUGENABSCHIEDER (4) |
| 27 | 25510068/0 | 2 | PERNO | PIN | PIVOT | BOLZEN |
| 28 | 12293201/0 | 2 | DADO | NUT | ECROU | MUTTER |
| 29 | 24487998/0 | 1 | COPPIGLIA | COTTER PIN | GOUPILLE | SPLIT |
| 31 | 82000207/0 | 1 | ACCELERATORE (12335) | ACCELERATOR (12335) | ACCELERATEUR (12335) | GAS ZUG (12335) |
| | 82000210/1 | 1 | ACCELERATORE (4) | ACCELERATOR (4) | ACCELERATEUR (4) | GAS ZUG (4) |





| N. | CODE | Q.TY | DESCRIZIONE | DESCRIPTION | DESCRIPTION | BESCHREIBUNG |
|-----|------------|------|--------------------------|----------------------------|-------------------------|----------------------|
| 32 | 12788512/0 | 2 | VITE | SCREW | VIS | SCHRAUBE |
| 33 | 12581200/0 | 2 | GROWER | GROWER | GROWER | GROWER |
| 34 | 25394501/0 | 1 | MANOPOLINA | HANDLE | POIGNE | GRIFF |
| 35 | 12726388/0 | 1 | VITE | SCREW | VIS | SCHRAUBE |
| 36 | 12290800/0 | 1 | DADO | NUT | ECROU | MUTTER |
| 41 | 25722463/0 | 1 | SEDILE | SEAT | SIEGE | SITZ |
| 43 | 25547033/1 | 1 | PIASTRA | PLATE | PLAQUE | PLATTE |
| 44 | 12793101/0 | 4 | VITE | SCREW | VIS | SCHRAUBE |
| 45 | 12583500/0 | 4 | GROWER | GROWER | GROWER | GROWER |
| 46 | 12523060/0 | 4 | RONDELLA | WASHER | RONDELLE | SCHEIBE |
| 47 | 25430223/2 | 1 | MOLLA | SPRING | RESSORT | FEDER |
| 48 | 12789000/0 | 1 | VITE | SCREW | VIS | SCHRAUBE |
| 49 | 12154330/0 | 1 | DADO | NUT | ECROU | MUTTER |
| 51 | 25961212/0 | 1 | VOLANTE | STEERING WHEEL | VOLANT | LENKRAD |
| 52 | 12620299/0 | 1 | SPINA | PIN | GOUPILLE | STIFT |
| 54 | 27063021/1 | 1 | CAMMA | CAM | CAME | NOCKEN |
| 55 | 12789100/0 | 2 | VITE | SCREW | VIS | SCHRAUBE |
| 56 | 12523020/0 | 2 | RONDELLA | WASHER | RONDELLE | SCHEIBE |
| 57 | 12154330/0 | 2 | DADO | NUT | ECROU | MUTTER |
| 61 | 25110179/1 | 1 | COPERTURA ROSSO | COVER RED | COUVRE ROUGE | KAPPE ROT |
| | 25110300/0 | | NERO | BLACK | NOIR | SCHWARZ |
| 62 | 25600061/0 | 1 | PROTEZ. DESTRA, GRIGIA | RIGHT GUARD, GREY | PROTECTION DROITE, GRIS | RECHTE SCHUTZE, GRAU |
| 63 | 25600065/0 | 1 | PROTEZ. SINISTRA, GRIGIA | LEFT GUARD, GREY | PROTECTION GAUCHE, GRIS | LINKE SCHUTZE, GRAU |
| 64 | 12735402/0 | 6 | VITE | SCREW | VIS | SCHRAUBE |
| 65 | 12734995/0 | 2 | VITE | SCREW | VIS | SCHRAUBE |
| 66 | 12735402/0 | 3 | VITE | SCREW | VIS | SCHRAUBE |
| 67 | 12735402/0 | 6 | VITE | SCREW | VIS | SCHRAUBE |
| 71 | 25110178/2 | 1 | COPERTURA SACCO ROSSO | GRASS-CATCHER COVER RED | COUVRE-BAC ROUGE | SACKKAPPE ROT |
| | 25110299/0 | | NERO | BLACK | NOIR | SCHWARZ |
| 72 | 12729601/1 | 4 | VITE | SCREW | VIS | SCHRAUBE |
| 73 | 12521331/0 | 4 | RONDELLA | WASHER | RONDELLE | SCHEIBE |
| 81 | 25600020/0 | 1 | PROTEZIONE SUPERIORE | UPPER GUARD | PROTECTION SUPERIEUR | OBERSCHUTZ |
| 82 | 25600021/1 | 1 | PROTEZIONE INFERIORE | LOWER GUARD | PROTECTION INFERIEUR | UNTERSCHUTZ |
| 83 | 12728460/0 | 2 | VITE | SCREW | VIS | SCHRAUBE |
| 84 | 12521320/0 | 2 | ROSETTA | WASHER | RONDELLE | SCHEIBE |
| 85 | 12437502/0 | 2 | PIASTRINA | PLATE | PLAQUE | PLÄTTE |
| 91 | 25735116/2 | 1 | SERBATOIO | TANK | RESERVOIR | TANK |
| 92 | 25795000/1 | 1 | TAPPO | CAP | BOUCHON | TANKVERSCHLUSS |
| 93 | 25774258/0 | 1 | SUPPORTO | SUPPORT | SUPPORT | HALTER |
| 94 | 12735110/0 | 1 | VITE | SCREW | VIS | SCHRAUBE |
| 101 | 82869019/0 | 1 | PROTEZIONE SILENZIATORE | MUFFLER PROTECTION | PROTECTION SILENCIEUX | AUSPUFFSCHUTZ |
| 102 | 18737857/0 | 2 | PUNTALE | CAP | BOUCHON | PFROPFEN |
| 103 | 12734995/0 | 4 | VITE | SCREW | VIS | SCHRAUBE |
| 104 | 25547109/1 | 2 | PIASTRINA | PLATE | PLAQUE | PLATTE |
| 106 | 12731580/0 | 4 | VITE | SCREW | VIS | SCHRAUBE |

J JP JT JR JTP JB JX

92

92 hydro

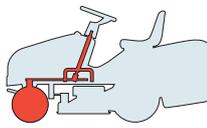

STERZO
STEERING
BARRE DE DIRECTION
LENKGETRIEBE

2006

003.0

1 / 2

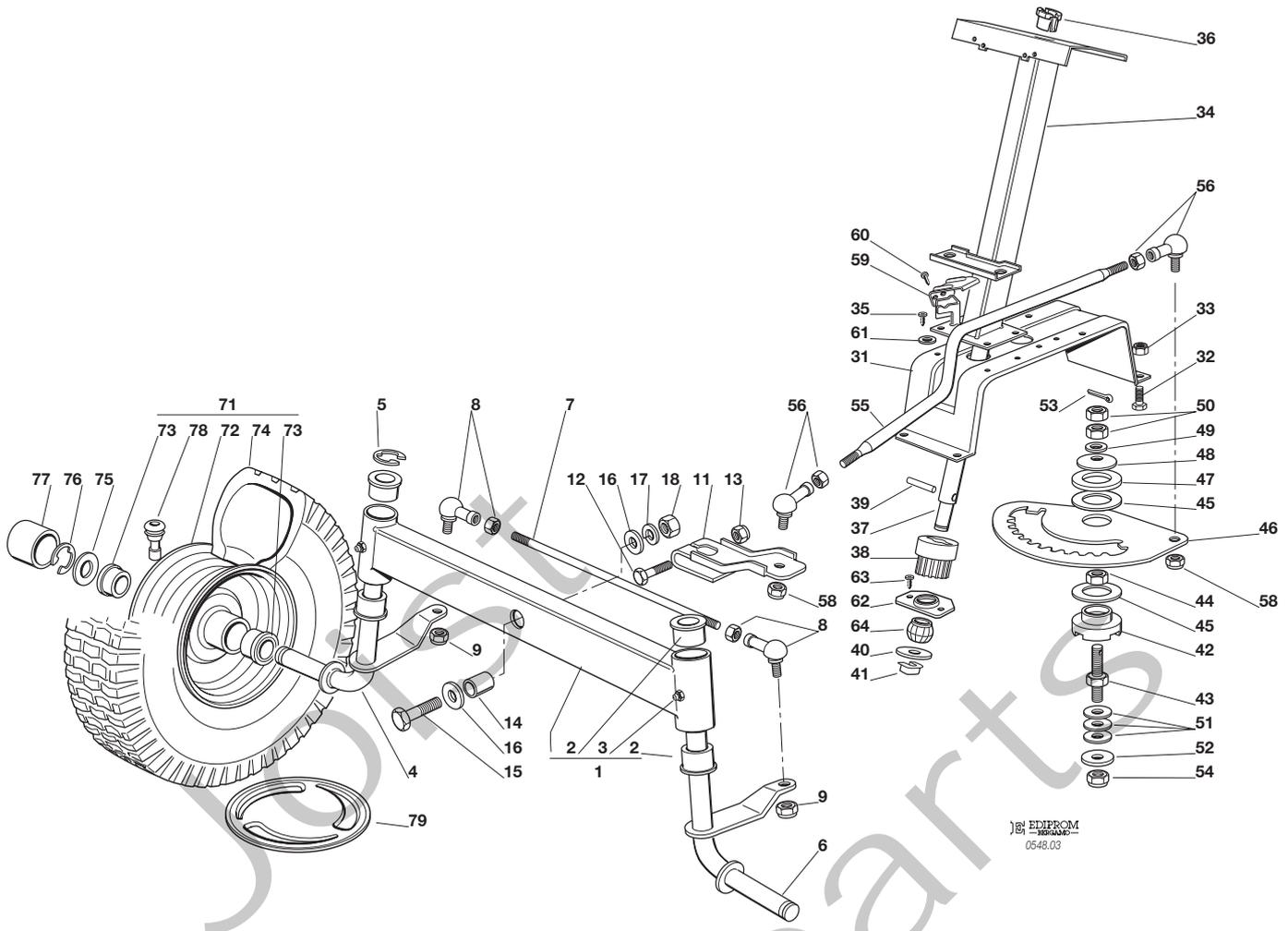

EDIPROM
0548.03

| N. | CODE | Q.TY | DESCRIZIONE | DESCRIPTION | DESCRIPTION | BESCHREIBUNG |
|----|------------|------|----------------------------------------|------------------------------------|-------------------------------------|------------------------------------|
| 1 | 82034008/0 | 1 | BILANCIERE CON BOCCOLA ED INGRASSATORE | EQUALIZER WITH BUSH AND LUBRICATOR | BALANCIER AVEC DOUILLE ET GRAISSEUR | KIPPEBEL MIT BÜCHSE UND FETTBÜCHSE |
| 2 | 25034002/1 | 4 | BOCCOLA | BUSH | DOUILLE | BÜCHSE |
| 3 | 12379511/0 | 2 | INGRASSATORE | GREASE DISPENSER | GRAISSEUR | FETTBÜCHSE |
| 4 | 82230355/0 | 1 | FUSELLO DESTRO | RIGHT STUB AXLE | FUSEAU DROITE | RECHTER ACHSSCHENKEL |
| 5 | 12001000/0 | 1 | ANELLO ELASTICO | SNAP RING | ANNEAU RESSORT | SPRENGRING |
| 6 | 82230357/0 | 1 | FUSELLO SINISTRO | LEFT STUB AXLE | FUSEAU GAUCHE | LINKER ACHSSCHENKEL |
| 7 | 25840006/0 | 1 | TIRANTE COLLEG. FUSELLI | TIE ROD | TIRANT | SPANNSTANGE |
| 8 | 22746600/0 | 2 | SNODO | JOINT | JOINT | GELENK |
| 9 | 12156602/0 | 2 | DADO | NUT | ECROU | MUTTER |
| 11 | 25318142/0 | 1 | LEVA | LEVER | LEVIER | HEBEL |
| 12 | 12692390/0 | 1 | VITE | SCREW | VIS | SCHRAUBE |
| 13 | 12156602/0 | 1 | DADO | NUT | ECROU | MUTTER |
| 14 | 25160016/0 | 1 | DISTANZIALE | SPACER | ENTRETOISE | ENTFERNUNGSSTÜCK |
| 15 | 12692695/0 | 1 | VITE | SCREW | VIS | SCHRAUBE |
| 16 | 12523100/0 | 2 | RONDELLA | WASHER | RONDELLE | SCHEIBE |
| 17 | 12587100/0 | 1 | GROWER | GROWER | GROWER | GROWER |
| 18 | 12295300/0 | 1 | DADO | NUT | ECROU | MUTTER |
| 31 | 25785101/0 | 1 | SUPPORTO | SUPPORT | SUPPORT | HALTER |
| 32 | 12792611/0 | 4 | VITE | SCREW | VIS | SCHRAUBE |
| 33 | 12155000/0 | 4 | DADO | NUT | ECROU | MUTTER |
| 34 | 82785135/0 | 1 | SUPPORTO | SUPPORT | SUPPORT | HALTER |
| 35 | 12735120/0 | 4 | VITE | SCREW | VIS | SCHRAUBE |
| 36 | 25038004/0 | 1 | BOCCOLA | BUSH | DOUILLE | BÜCHSE |
| 37 | 25520004/0 | 1 | PIANTONE | STEERING COLUMN | TUBE DE DIRECTION | LENKUNGSÄULE |
| 38 | 25570000/2 | 1 | PIGNONE | PINION | PIGNON | RITZEL |
| 39 | 12622650/0 | 1 | SPINA | PIN | GOUPILLE | STIFT |
| 40 | 12521370/0 | 1 | RONDELLA | WASHER | RONDELLE | SCHEIBE |
| 41 | 12436030/0 | 1 | PIASTRINA | PLATE | PLAQUETTE | PLATTECHEN |





| N. | CODE | Q.TY | DESCRIZIONE | DESCRIPTION | DESCRIPTION | BESCHREIBUNG |
|----|------------|------|---------------------|---------------------------|------------------------------|---------------------|
| 42 | 25040617/0 | 1 | BUSSOLA | BUSH | DOUILLE | BÜCHSE |
| 43 | 25510065/1 | 1 | PERNO | PIN | PIVOT | BOLZEN |
| 44 | 12295200/0 | 1 | DADO | NUT | ECROU | MUTTER |
| 45 | 25670012/0 | 2 | RONDELLA | WASHER | RONDELLE | SCHEIBE |
| 46 | 25735507/0 | 1 | SETTORE | STEERING SHAFT | ARBRE DIRECTION | LENKUNGSWELLE |
| 47 | 25670014/0 | 1 | RONDELLA | WASHER | RONDELLE | SCHEIBE |
| 48 | 22160400/0 | 1 | DISCO ELASTICO | ELASTIC WASHER | DISQUE ELASTIQUE | FEDERSCHEIBE |
| 49 | 12521360/0 | 1 | ROSETTA | WASHER | RONDELLE | SCHEIBE |
| 50 | 12295200/0 | 2 | DADO | NUT | ECROU | MUTTER |
| 51 | 22672150/0 | 3 | RONDELLA | WASHER | RONDELLE | SCHEIBE |
| 52 | 12523080/0 | 1 | RONDELLA | WASHER | RONDELLE | SCHEIBE |
| 53 | 12141418/0 | 1 | COPPIGLIA | COTTER PIN | GOUPILLE | SPLIT |
| 54 | 12156602/0 | 1 | DADO | NUT | ECROU | MUTTER |
| 55 | 25033025/0 | 1 | ASTA COM. STERZO | STEERING ROD DIRECTION | LEVIER BARRE DE DIRECTION | LENKUNGSSTAB |
| 56 | 22746600/0 | 2 | SNODO | JOINT | JOINT | GELENK |
| 58 | 12156602/0 | 2 | DADO | NUT | ECROU | MUTTER |
| 59 | 25600036/0 | 1 | PROTEZIONE MICRO | MICRO PROTECTION | PROTECTION MICRO | SCHUTZ |
| 60 | 12727810/0 | 2 | VITE | SCREW | VIS | SCHRAUBE |
| 61 | 12521330/0 | 2 | RONDELLA (J - JP) | WASHER (J - JP) | RONDELLE (J - JP) | SCHEIBE (J - JP) |
| 62 | 25785213/0 | 1 | SUPPORTO | SUPPORT | SUPPORT | HALTER |
| 63 | 12729601/1 | 2 | VITE | SCREW | VIS | SCHRAUBE |
| 64 | 25743000/0 | 1 | SNODO | JOINT | JOINT | GELENK |
| 71 | • | 2 | RUOTA ANTERIORE | FRONT WHEEL | ROUE AVANT | VORDERRAD |
| | 82680002/2 | | TURF SAVER CARLISLE | TURF SAVER CARLISLE | TURF SAVER CARLISLE | TURF SAVER CARLISLE |
| | 82680005/1 | | DELI TIRE | DELI TIRE | DELI TIRE | DELI TIRE |
| 72 | 82000590/0 | 2 | CERCHIO RUOTA | RIMM | BANDAGE ROUE | VORDERRAD FELGER |
| 73 | 25122200/2 | 4 | CUSCINETTO | BEARING | ROULEMENT | LAGER |
| 74 | • | 2 | PNEUMATICO | SHOE | PNEU | REIFEN |
| | 25590000/0 | | TURF SAVER CARLISLE | TURF SAVER CARLISLE | TURF SAVER CARLISLE | TURF SAVER CARLISLE |
| | 25590002/0 | | DELI TIRE | DELI TIRE | DELI TIRE | DELI TIRE |
| 75 | 25670005/1 | 2 | RONDELLA | WASHER | RONDELLE | SCHEIBE |
| 76 | 12001000/0 | 2 | ANELLO ELASTICO | SNAP RING | ANNEAU RESSORT | SPRENGRING |
| 77 | 22110230/0 | 2 | COPRIMOZZO | HUB COVER | COUVRE MOYEU | NABEDECKEL |
| 78 | 25950000/0 | 2 | VALVOLA | VALVE | SOUPAPE | VENTIL |
| 79 | 82110252/0 | 2 | COPRIMOZZO | HUB COVER | COUVRE MOYEU | NABEDECKEL |

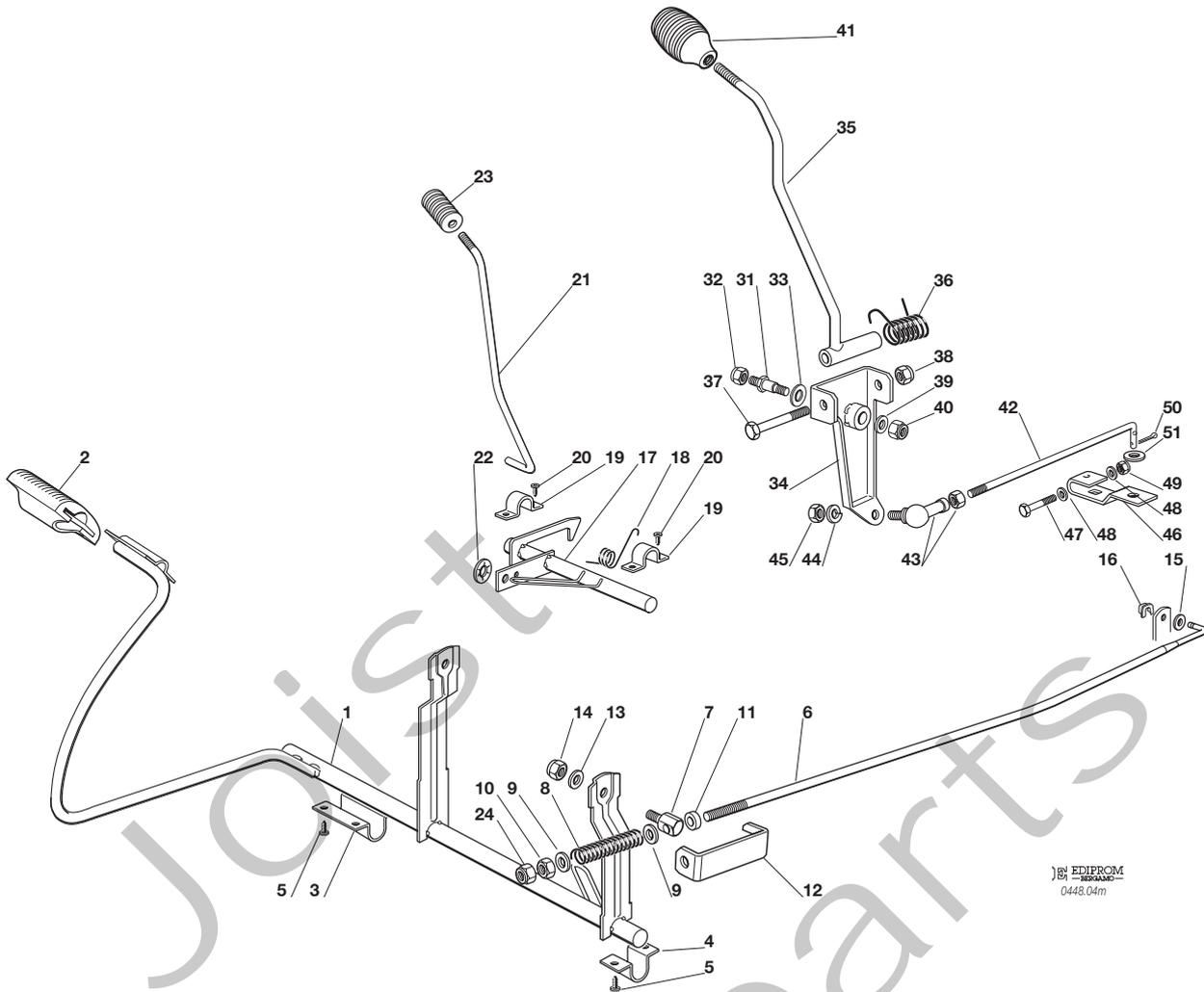
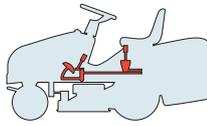

EDIPROM
0448,04m

| N. | CODE | Q.TY | DESCRIZIONE | DESCRIPTION | DESCRIPTION | BESCHREIBUNG |
|----|------------|------|---------------------|----------------|---------------------|------------------|
| 1 | 82500002/1 | 1 | PEDALE | PEDAL | PEDAL | PEDAL |
| 2 | 25110269/0 | 1 | COPRISTAFFA | CLAMP COVER | COUVRE ETRIER | BRIDEDECKEL |
| 3 | 25547039/0 | 1 | PIASTRINA DESTRA | RIGHT PLATE | PLAQUE DROITE | RECHTE PLATTE |
| 4 | 25547041/0 | 1 | PIASTRINA SINISTRA | LEFT PLATE | PLATE GAUCHE | LINKE PLATTE |
| 5 | 12731601/0 | 6 | VITE | SCREW | VIS | SCHRAUBE |
| 6 | 25033036/0 | 1 | ASTA | ROD | BARRE | STANGE |
| 7 | 25510060/0 | 1 | PERNO | PIN | PIVOT | BOLZEN |
| 8 | 25430236/0 | 1 | MOLLA | SPRING | RESSORT | FEDER |
| 9 | 12521360/0 | 2 | ROSETTA | WASHER | RONDELLE | SCHEIBE |
| 10 | 12295200/0 | 1 | DADO | NUT | ECROU | MUTTER |
| 11 | 25160026/0 | 1 | DISTANZIALE | SPACER | ENTRETOISE | ENTFERNUNGSSTÜCK |
| 12 | 25774275/0 | 1 | STAFFA | CLAMP | ETRIER | BRIDE |
| 13 | 12523040/0 | 1 | RONDELLA | WASHER | RONDELLE | SCHEIBE |
| 14 | 12154510/0 | 1 | DADO | NUT | ECROU | MUTTER |
| 15 | 12521350/0 | 1 | RONDELLA | WASHER | RONDELLE | SCHEIBE |
| 16 | 12436050/0 | 1 | PIASTRINA | PLATE | PLAQUE | PLATTE |
| 17 | 82000361/0 | 1 | ASSE AZIONAM. MICRO | AXLE | AXE | ACHSE |
| 18 | 25430234/0 | 1 | MOLLA | SPRING | RESSORT | FEDER |
| 19 | 25547049/0 | 2 | PIASTRINA | PLATE | PLAQUE | PLATTE |
| 20 | 12731601/0 | 4 | VITE | SCREW | VIS | SCHRAUBE |
| 21 | 25033043/0 | 1 | ASTA | ROD | BARRE | STANGE |
| 22 | 12604898/0 | 1 | FISSATORE A CORONA | CROWN FASTENER | FIXATEUR A COURONNE | KRONESCHEIBE |
| 23 | 27395050/1 | 1 | MANOPOLA | KNOB | POIGNEE | KNOPF |
| 24 | 12156602/0 | 1 | DADO | NUT | ECROU | MUTTER |
| 31 | 25510035/0 | 1 | PERNO | PIN | PIVOT | BOLZEN |
| 32 | 12155010/0 | 1 | DADO | NUT | ECROU | MUTTER |
| 33 | 22672151/0 | 1 | RONDELLA | WASHER | RONDELLE | SCHEIBE |
| 34 | 82774206/0 | 1 | STAFFA | CLAMP | ETRIER | BRIDE |
| 35 | 82318134/0 | 1 | LEVA | GEARSHIFT | LEVIER | HEBEL |





| N. | CODE | Q.TY | DESCRIZIONE | DESCRIPTION | DESCRIPTION | BESCHREIBUNG |
|----|------------|------|------------------------|-----------------------|-------------------------|--------------------------|
| 36 | 25430226/0 | 1 | MOLLA | SPRING | RESSORT | FEDER |
| 37 | 12692050/0 | 1 | VITE | SCREW | VIS | SCHRAUBE |
| 38 | 12155000/0 | 1 | DADO | NUT | ECROU | MUTTER |
| 39 | 12523060/0 | 1 | RONDELLA | WASHER | RONDELLE | SCHEIBE |
| 40 | 12155010/0 | 1 | DADO | NUT | ECROU | MUTTER |
| 41 | 25394510/0 | 1 | MANOPOLA | KNOB | POIGNEE | WECHSEL |
| 42 | 25033012/0 | 1 | ASTA (Peerless) | ROD (Peerless) | BARRE (Peerless) | STANGE (Peerless) |
| | 25840020/0 | 1 | ASTA (Dana) | ROD (Dana) | BARRE (Dana) | STANGE (Dana) |
| 43 | 22746601/0 | 1 | SNODO | JOINT | JOINT | GELENK |
| 44 | 12583500/0 | 1 | GROWER | GROWER | GROWER | GROWER |
| 45 | 12293200/0 | 1 | DADO | NUT | ECROU | MUTTER |
| 46 | 25318128/0 | 1 | LEVA | GEARSHIFT | LEVIER | HEBEL |
| 47 | 12689500/0 | 1 | VITE | SCREW | VIS | SCHRAUBE |
| 48 | 12521330/0 | 2 | RONDELLA | WASHER | RONDELLE | SCHEIBE |
| 49 | 12154510/0 | 1 | DADO | NUT | ECROU | MUTTER |
| 50 | 12141418/0 | 1 | COPPIGLIA | COTTER PIN | GOUPILLE | SPLIT |
| 51 | 12521340/0 | 1 | RONDELLA (Dana) | WASHER (Dana) | RONDELLE (Dana) | SCHEIBE (Dana) |

Joist
Spareparts
Joist

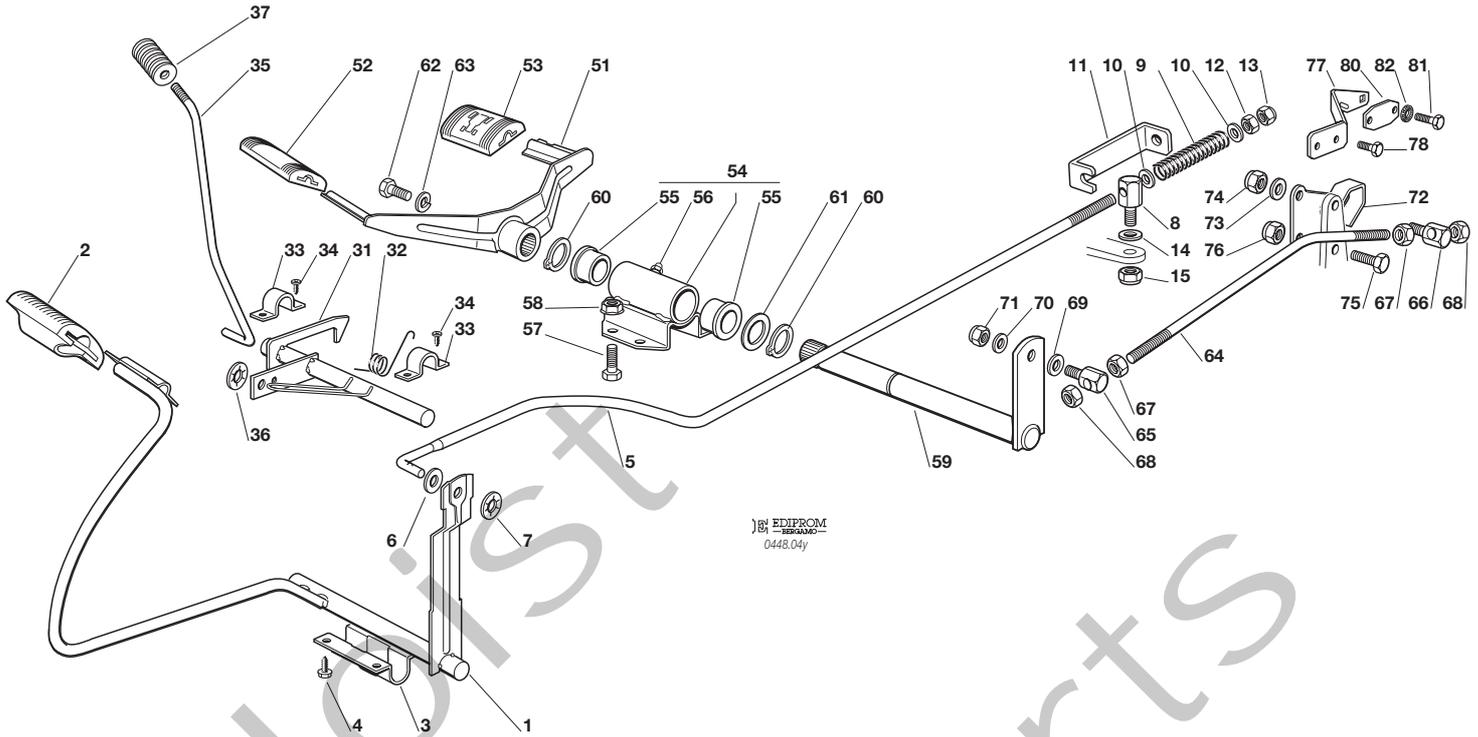
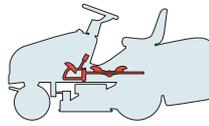

EDIPROM
0448.04y

| N. | CODE | Q.TY | DESCRIZIONE | DESCRIPTION | DESCRIPTION | BESCHREIBUNG |
|----|------------|------|------------------------|-------------------|-----------------------|--------------------|
| 1 | 82500017/0 | 1 | PEDALE | PEDAL | PEDAL | PEDAL |
| 2 | 25110267/0 | 1 | COPRISTAFFA | CLAMP COVER | COUVRE ETRIER | BRIDEDECKEL |
| 3 | 25547039/0 | 1 | PIASTRINA | PLATE | PLAQUE | PLATTE |
| 4 | 12731601/0 | 4 | VITE | SCREW | VIS | SCHRAUBE |
| 5 | 25033041/0 | 1 | ASTA | ROD | BARRE | STANGE |
| 6 | 12521350/0 | 1 | ROSETTA | WASHER | RONDELLE | SCHEIBE |
| 7 | 12604899/0 | 1 | FISSATORE A CORONA | CROWN FASTENER | FIXATEUR A COURONNE | KRONESCHEIBE |
| 8 | 25510067/1 | 1 | PERNO | PIN | PIVOT | BOLZEN |
| 9 | 25430236/0 | 1 | MOLLA | SPRING | RESSORT | FEDER |
| 10 | 12521360/0 | 2 | ROSETTA | WASHER | RONDELLE | SCHEIBE |
| 11 | 25774275/0 | 1 | STAFFA | CLAMP | ETRIER | BRIDE |
| 12 | 12295200/0 | 1 | DADO | NUT | ECROU | MUTTER |
| 13 | 12156602/0 | 1 | DADO | NUT | ECROU | MUTTER |
| 14 | 12521350/0 | 1 | RONDELLA | WASHER | RONDELLE | SCHEIBE |
| 15 | 12155000/0 | 1 | DADO | NUT | ECROU | MUTTER |
| 31 | 82000361/0 | 1 | ASSE AZIONAM. MICRO | AXLE | AXE | ACHSE |
| 32 | 25430234/0 | 1 | MOLLA | SPRING | RESSORT | FEDER |
| 33 | 25547049/0 | 2 | PIASTRINA | PLATE | PLAQUE | PLATTE |
| 34 | 12731601/0 | 4 | VITE | SCREW | VIS | SCHRAUBE |
| 35 | 25033043/0 | 1 | ASTA | ROD | BARRE | STANGE |
| 36 | 12604898/0 | 1 | FISSATORE A CORONA | CROWN FASTENER | FIXATEUR A COURONNE | KRONESCHEIBE |
| 37 | 27395050/1 | 1 | MANOPOLA | KNOB | POIGNEE | KNOPF |
| 51 | 82500008/0 | 1 | PEDALE AVANZAMENTO | DRIVE PEDAL | PEDALE TRANSMISSION | GETRIEBEPEDAL |
| 52 | 25110265/0 | 1 | COPRISTAFFA ANTERIORE | CLAMP COVER FRONT | COUVRE ETRIER AVANT | BRIDEDECKEL VORDE |
| 53 | 25110266/0 | 1 | COPRISTAFFA POSTERIORE | CLAMP COVER REAR | COUVRE ETRIER ARRIERE | BRIDEDECKEL HINTER |
| 54 | 82785110/0 | 1 | SUPPORTO | SUPPORT | SUPPORT | HALTER |
| 55 | 25034002/1 | 2 | BRONZINA | BUSH | DOUILLE | BÜCHSE |





| N. | CODE | Q.TY | DESCRIZIONE | DESCRIPTION | DESCRIPTION | BESCHREIBUNG |
|----|------------|------|--------------|------------------|-------------|--------------|
| 56 | 12379511/0 | 1 | INGRASSATORE | GREASE DISPENSER | GRAISSEUR | FETTBÜCHSE |
| 57 | 12791011/0 | 2 | VITE | SCREW | VIS | SCHRAUBE |
| 58 | 12292102/0 | 2 | DADO | NUT | ECROU | MUTTER |
| 59 | 82318183/0 | 1 | LEVA | GEARSHIFT | LEVIER | HEBEL |
| 60 | 12609260/0 | 2 | SEEGER | SEEGER | SEEGER | SEEGER |
| 61 | 22672153/0 | 1 | RONDELLA | WASHER | RONDELLE | SCHEIBE |
| 62 | 12792612/0 | 1 | VITE | SCREW | VIS | SCHRAUBE |
| 63 | 12583501/0 | 1 | GROWER | GROWER | GROWER | GROWER |
| 64 | 25033042/0 | 1 | ASTA | ROD | BARRE | STANGE |
| 65 | 25510054/0 | 1 | PERNO | PIN | PIVOT | BOLZEN |
| 66 | 25510066/0 | 1 | PERNO | PIN | PIVOT | BOLZEN |
| 67 | 12293200/0 | 2 | DADO | NUT | ECROU | MUTTER |
| 68 | 12155000/0 | 2 | DADO | NUT | ECROU | MUTTER |
| 69 | 12521360/0 | 1 | RONDELLA | WASHER | RONDELLE | SCHEIBE |
| 70 | 12523040/0 | 1 | RONDELLA | WASHER | RONDELLE | SCHEIBE |
| 71 | 12154510/0 | 1 | DADO | NUT | ECROU | MUTTER |
| 72 | 82774231/0 | 1 | CAMMA | CAM | CAME | KAMM |
| 73 | 12523040/0 | 1 | RONDELLA | WASHER | RONDELLE | SCHEIBE |
| 74 | 12154510/0 | 1 | DADO | NUT | ECROU | MUTTER |
| 75 | 12791213/1 | 1 | VITE | SCREW | VIS | SCHRAUBE |
| 76 | 12154510/0 | 1 | DADO | NUT | ECROU | MUTTER |
| 77 | 25774289/0 | 1 | STAFFA | CLAMP | ETRIER | BRIDE |
| 78 | 12735110/0 | 2 | VITE | SCREW | VIS | SCHRAUBE |
| 80 | 27546019/0 | 1 | PIASTRINA | PLATE | PLAQUETTE | PLATTE |
| 81 | 12735602/0 | 2 | VITE | SCREW | VIS | SCHRAUBE |
| 82 | 12540020/0 | 2 | RONDELLA | WASHER | RONDELLE | SCHEIBE |

Joist Spareparts Joist

J JP JT JR JTP JB JX

92

92 hydro

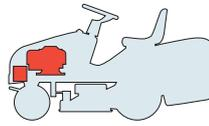

MOTORE
ENGINE
MOTEUR
MOTOR

B&S 11,5 - 12 - 12,5 - 13,5 HP

BRIGGS & STRATTON

2006

005.0

1 / 1

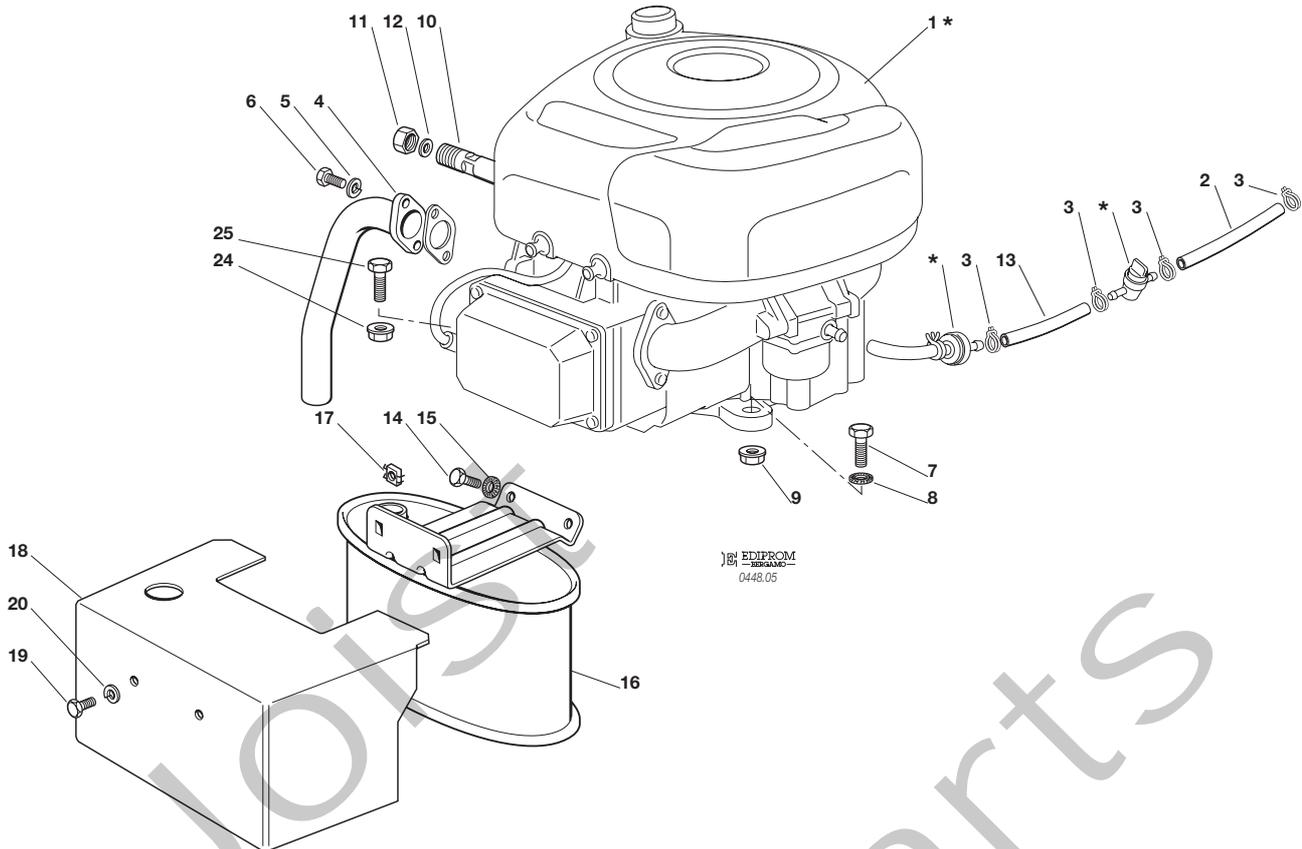

EDIPROM
- BERGAMO -
0448.05

| N. | CODE | Q.TY | DESCRIZIONE | DESCRIPTION | DESCRIPTION | BESCHREIBUNG |
|----|------------|------|-----------------------|-------------------------|-----------------------|------------------|
| 1* | — | 1 | MOTORE | ENGINE | MOTEUR | MOTOR |
| 2 | 25869009/1 | 1 | TUBO COLLEGAMENTO | CONNECTING TUBE | TUBE DE CONNEXION | VERBINDUNGSROHR |
| 3 | 18375051/1 | 4 | FASCETTA | FAIR LED | FIXATION DE CABLE | KABELBEFESTIGUNG |
| 4 | 18738224/0 | 1 | TUBO SCARICO | EXHAUST TUBE | TUBE ECHAPPEMENT | ABGASUNGROHR |
| 5 | 12583500/0 | 2 | GROWER | GROWER | GROWER | GROWER |
| 6 | 12735530/0 | 2 | VITE | SCREW | VIS | SCHRAUBE |
| 7 | 12691115/0 | 1 | VITE | SCREW | VIS | SCHRAUBE |
| 8 | 12540260/0 | 1 | RONDELLA | WASHER | RONDELLE | SCHEIBE |
| 9 | 12154210/0 | 1 | DADO | NUT | ECROU | MUTTER |
| 10 | 25598050/0 | 1 | PROLUNGA SCARICO OLIO | OIL DISCHARGE EXTENSION | EXTENSION DECH. HUILE | ÖL ABFLUSS |
| 11 | 18737849/0 | 1 | TAPPO PROLUNGA | OIL CAP | BOUCHON HUILE | OELVERSCHLUSS |
| 12 | 18401001/1 | 1 | GUARNIZIONE | OIL SEAL | GARNITURE | DICHTUNG |
| 13 | 25869006/1 | 1 | TUBO COLLEGAMENTO | CONNECTING TUBE | TUBE DE CONNEXION | VERBINDUNGSROHR |
| 14 | 12793102/0 | 2 | VITE | SCREW | VIS | SCHRAUBE |
| 15 | 12540260/0 | 2 | RONDELLA | WASHER | RONDELLE | SCHEIBE |
| 16 | 82750004/0 | 1 | SILENZIATORE | MUFFLER | SILENCEUX | AUSPUFF |
| 17 | 12360425/0 | 2 | DADO | NUT | ECROU | MUTTER |
| 18 | 82598009/2 | 1 | PROTEZIONE | GUARD | PROTECTION | SCHUTZE |
| 19 | 12792611/0 | 2 | VITE | SCREW | VIS | SCHRAUBE |
| 20 | 12583500/0 | 2 | GROWER | GROWER | GROWER | GROWER |
| 24 | 12154210/0 | 3 | DADO | NUT | ECROU | MUTTER |
| 25 | 12691100/0 | 3 | VITE | SCREW | VIS | SCHRAUBE |

PER LA SOSTITUZIONE DELLE PARTI CONTRASSEGNALE CON «*» RIVOLGERSI AL SERVIZIO ASSISTENZA DEL COSTRUTTORE DEL MOTORE.
 TO REPLACE THE PARTS MARKED «*» SEEK ASSISTANCE FROM THE ENGINE MANUFACTURER'S AFTER SALES SERVICE.
 POUR LE REMPLACEMENT DES PIÈCES MARQUÉES AVEC «*» S'ADRESSER AU SERVICE APRÈS VENTES DU CONSTRUCTEUR DU MOTEUR.
 ZUM AUSTAUSCH DER MIT «*» GEKENNZEICHNETEN TEILE, WENDEN SIE SICH AN DEN KUNDENDIENST DES HERSTELLERS DES MOTOR.

| | | | | | | |
|----|----|----|----|----------|----|----|
| J | JP | JT | JR | JTP | JB | JX |
| 92 | | | | 92 hydro | | |

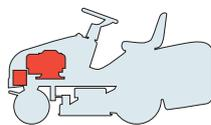

**MOTORE
ENGINE
MOTEUR
MOTOR**
B&S 15,5 HP



2006
005a.0
1 / 1

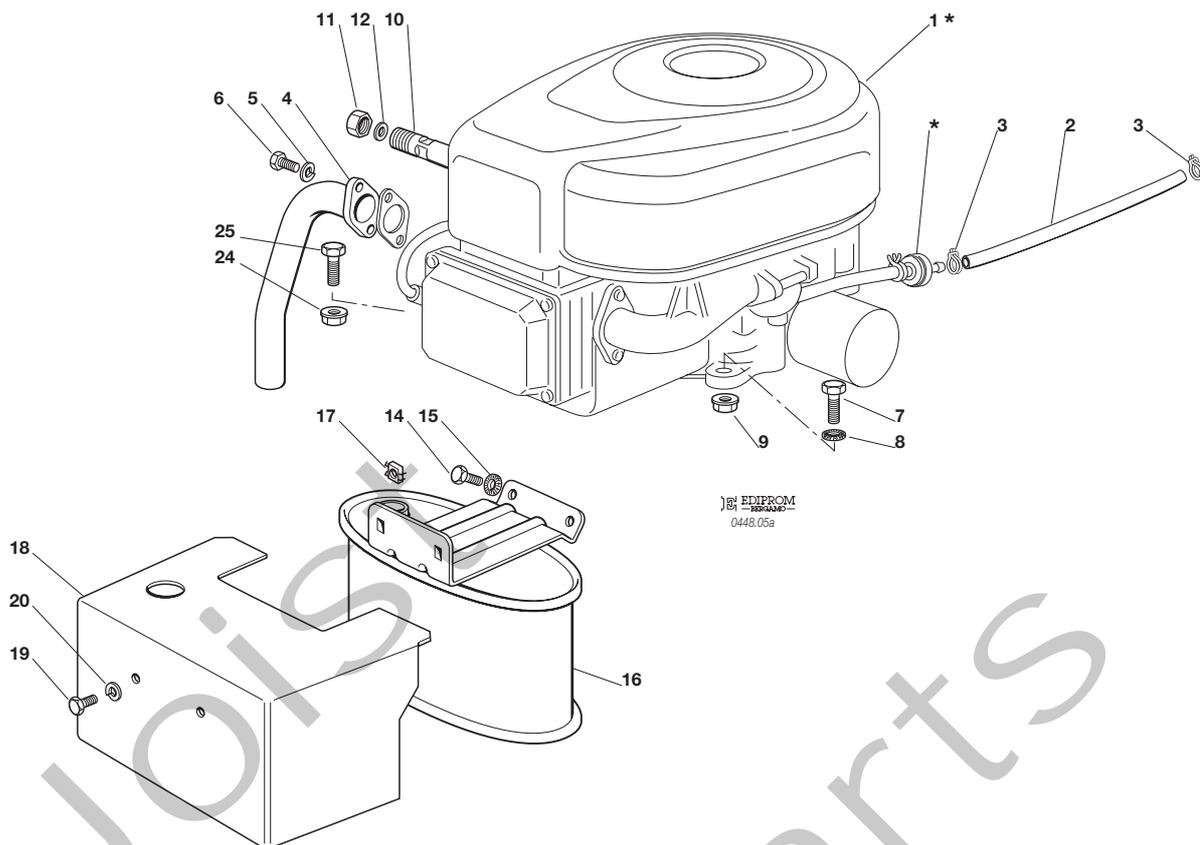

EDIPROM
0448.05a

| N. | CODE | Q.TY | DESCRIZIONE | DESCRIPTION | DESCRIPTION | BESCHREIBUNG |
|----|------------|------|-----------------------|-------------------------|-----------------------|------------------|
| 1* | — | 1 | MOTORE | ENGINE | MOTEUR | MOTOR |
| 2 | 25869016/1 | 1 | TUBO COLLEGAMENTO | CONNECTING TUBE | TUBE DE CONNEXION | VERBINDUNGSROHR |
| 3 | 18375051/1 | 2 | FASCETTA | FAIR LED | FIXATION DE CABLE | KABELBEFESTIGUNG |
| 4 | 18738206/0 | 1 | TUBO SCARICO | EXHAUST TUBE | TUBE ECHAPPEMENT | ABGASUNGROHR |
| 5 | 12583500/0 | 2 | GROWER | GROWER | GROWER | GROWER |
| 6 | 12735530/0 | 2 | VITE | SCREW | VIS | SCHRAUBE |
| 7 | 12691115/0 | 1 | VITE | SCREW | VIS | SCHRAUBE |
| 8 | 12540260/0 | 1 | RONDELLA | WASHER | RONDELLE | SCHEIBE |
| 9 | 12154210/0 | 1 | DADO | NUT | ECROU | MUTTER |
| 10 | 25598050/0 | 1 | PROLUNGA SCARICO OLIO | OIL DISCHARGE EXTENSION | EXTENSION DECH. HUILE | ÖL ABFLUSS |
| 11 | 18737849/0 | 1 | TAPPO PROLUNGA | OIL CAP | BOUCHON HUILE | OELVERSCHLUSS |
| 12 | 18401001/1 | 1 | GUARNIZIONE | OIL SEAL | GARNITURE | DICHTUNG |
| 14 | 12793102/0 | 2 | VITE | SCREW | VIS | SCHRAUBE |
| 15 | 12540260/0 | 2 | RONDELLA | WASHER | RONDELLE | SCHEIBE |
| 16 | 82750004/0 | 1 | SILENZIATORE | MUFFLER | SILENCEUX | AUSPUFF |
| 17 | 12360425/0 | 2 | DADO | NUT | ECROU | MUTTER |
| 18 | 82598009/2 | 1 | PROTEZIONE | GUARD | PROTECTION | SCHUTZE |
| 19 | 12792611/0 | 2 | VITE | SCREW | VIS | SCHRAUBE |
| 20 | 12583500/0 | 2 | GROWER | GROWER | GROWER | GROWER |
| 24 | 12154210/0 | 3 | DADO | NUT | ECROU | MUTTER |
| 25 | 12691100/0 | 3 | VITE | SCREW | VIS | SCHRAUBE |

PER LA SOSTITUZIONE DELLE PARTI CONTRASSEGNALE CON «*» RIVOLGERSI AL SERVIZIO ASSISTENZA DEL COSTRUTTORE DEL MOTORE.
TO REPLACE THE PARTS MARKED «*» SEEK ASSISTANCE FROM THE ENGINE MANUFACTURER'S AFTER SALES SERVICE.
POUR LE REMPLACEMENT DES PIÈCES MARQUÉES AVEC «*» S'ADRESSER AU SERVICE APRÈS VENTES DU CONSTRUCTEUR DU MOTEUR.
ZUM AUSTAUSCH DER MIT «*» GEKENNZEICHNETEN TEILE, WENDEN SIE SICH AN DEN KUNDENDIENST DES HERSTELLERS DES MOTOR.

J JP JT JR JTP JB JX

92

92 hydro

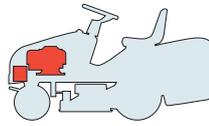

MOTORE
ENGINE
MOTEUR
MOTOR
TECUMSEH 11,5 - 13 - 13,5 HP



2006

005b.0

1 / 1

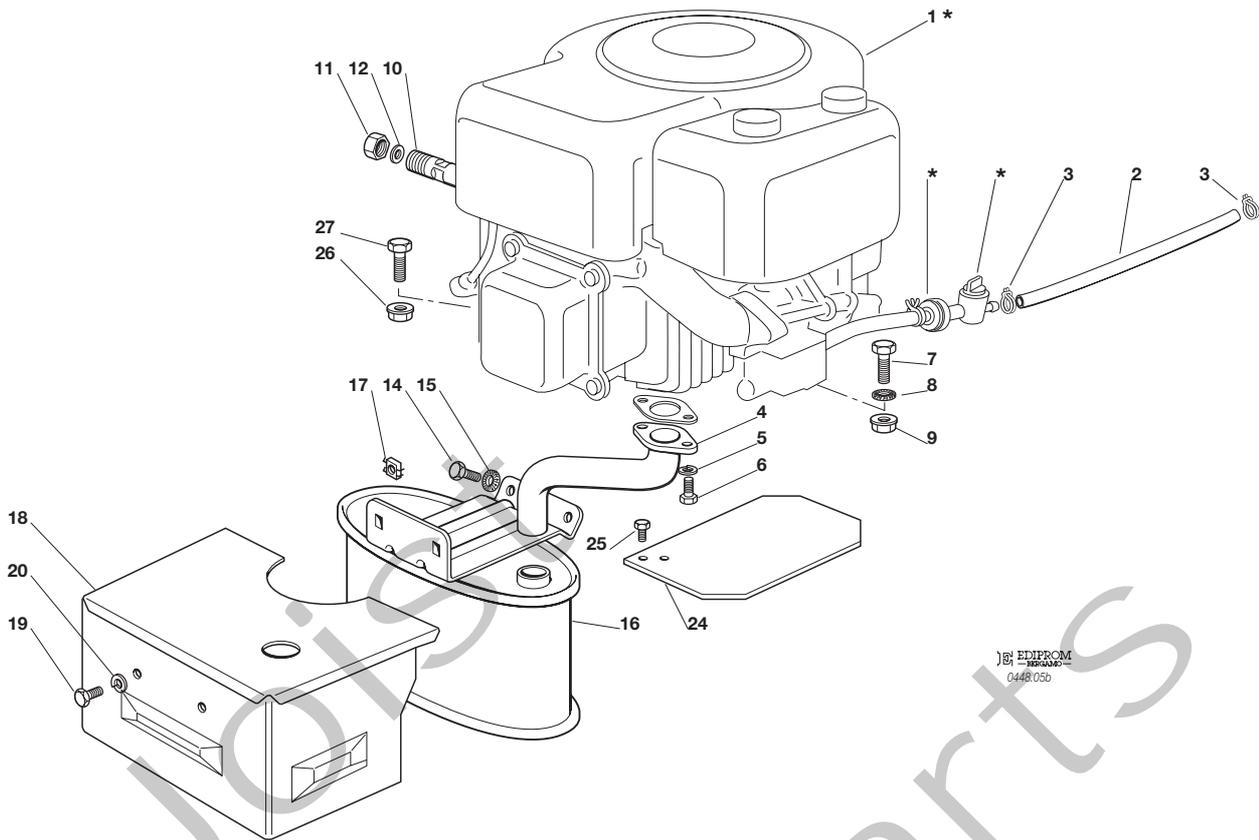

EDIPROM
0448.C50

| N. | CODE | Q.TY | DESCRIZIONE | DESCRIPTION | DESCRIPTION | BESCHREIBUNG |
|----|------------|------|-------------------------|-------------------------|-----------------------|------------------|
| 1* | — | 1 | MOTORE | ENGINE | MOTEUR | MOTOR |
| 2 | 25869010/1 | 1 | TUBO COLLEGAMENTO | CONNECTING TUBE | TUBE DE CONNEXION | VERBINDUNGSROHR |
| 3 | 18375051/1 | 5 | FASCETTA | FAIR LED | FIXATION DE CABLE | KABELBEFESTIGUNG |
| 4 | 18738211/0 | 1 | TUBO SCARICO | EXHAUST TUBE | TUBE ECHAPPEMENT | ABGASUNGROHR |
| 5 | 12583500/0 | 2 | GROWER | GROWER | GROWER | GROWER |
| 6 | 12735530/0 | 2 | VITE | SCREW | VIS | SCHRAUBE |
| 7 | 12691115/0 | 1 | VITE | SCREW | VIS | SCHRAUBE |
| 8 | 12540260/0 | 1 | RONDELLA | WASHER | RONDELLE | SCHEIBE |
| 9 | 12154210/0 | 1 | DADO | NUT | ECROU | MUTTER |
| 10 | 25598050/0 | 1 | PROLUNGA SCARICO OLIO | OIL DISCHARGE EXTENSION | EXTENSION DECH. HUILE | ÖL ABFLUSS |
| 11 | 18737849/0 | 1 | TAPPO PROLUNGA | OIL CAP | BOUCHON HUILE | OELVERSCHLUSS |
| 12 | 18401001/1 | 1 | GUARNIZIONE | OIL SEAL | GARNITURE | DICHTUNG |
| 14 | 12793102/0 | 2 | VITE | SCREW | VIS | SCHRAUBE |
| 15 | 12540260/0 | 2 | RONDELLA | WASHER | RONDELLE | SCHEIBE |
| 16 | 82750005/0 | 1 | SILENZIATORE | MUFFLER | SILENCEUX | AUSPUFF |
| 17 | 12360425/0 | 2 | DADO | NUT | ECROU | MUTTER |
| 18 | 82598017/0 | 1 | PROTEZIONE | GUARD | PROTECTION | SCHUTZE |
| 19 | 12792611/0 | 2 | VITE | SCREW | VIS | SCHRAUBE |
| 20 | 12583500/0 | 2 | GROWER | GROWER | GROWER | GROWER |
| 24 | 25600031/0 | 1 | PROTEZIONE SILENZIATORE | MUFFLER PROTECTION | PROTECTION SILENCIEUX | AUSPUFFSCHUTZ |
| 25 | 12735106/0 | 2 | VITE | SCREW | VIS | SCHRAUBE |
| 26 | 12154210/0 | 3 | DADO | NUT | ECROU | MUTTER |
| 27 | 12691100/0 | 3 | VITE | SCREW | VIS | SCHRAUBE |

PER LA SOSTITUZIONE DELLE PARTI CONTRASSEGNALE CON «*» RIVOLGERSI AL SERVIZIO ASSISTENZA DEL COSTRUTTORE DEL MOTORE.
 TO REPLACE THE PARTS MARKED «*» SEEK ASSISTANCE FROM THE ENGINE MANUFACTURER'S AFTER SALES SERVICE.
 POUR LE REMPLACEMENT DES PIÈCES MARQUÉES AVEC «*» S'ADRESSER AU SERVICE APRÈS VENTES DU CONSTRUCTEUR DU MOTEUR.
 ZUM AUSTAUSCH DER MIT «*» GEKENNZEICHNETEN TEILE, WENDEN SIE SICH AN DEN KUNDENDIENST DES HERSTELLERS DES MOTOR.

| | | | | | | |
|----|----|----|----|----------|----|----|
| J | JP | JT | JR | JTP | JB | JX |
| 92 | | | | 92 hydro | | |

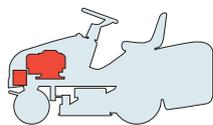

MOTORE
ENGINE
MOTEUR
MOTOR

POWERED by
HONDA

HONDA GCV 520 - 14 HP

2006

005c.0

1 / 1

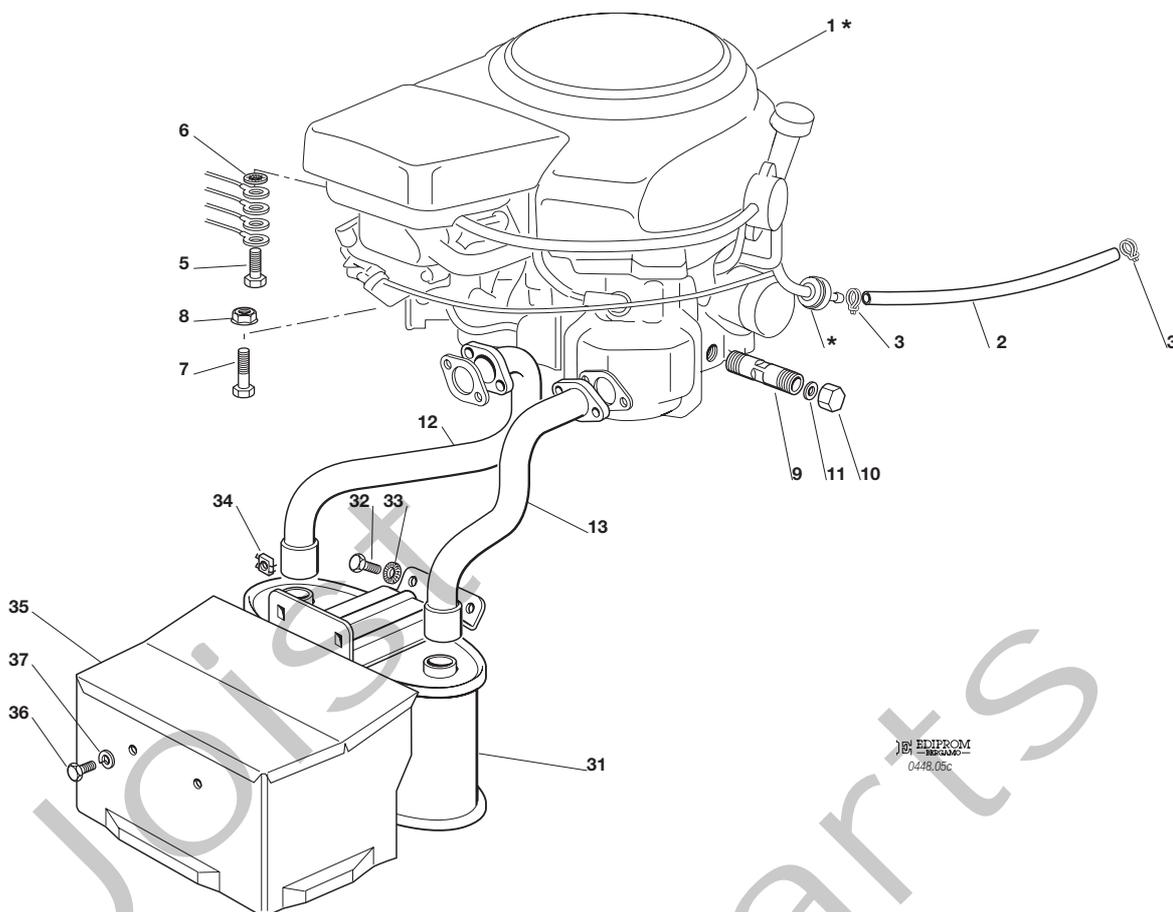

| N. | CODE | Q.TY | DESCRIZIONE | DESCRIPTION | DESCRIPTION | BESCHREIBUNG |
|----|------------|------|-----------------------|-------------------------|------------------------|----------------------|
| 1* | — | 1 | MOTORE | ENGINE | MOTEUR | MOTOR |
| 2 | 25869027/1 | 1 | TUBO COLLEGAMENTO | CONNECTING TUBE | TUBE DE CONNEXION | VERBINDUNGSRÖHR |
| 3 | 18375051/1 | 2 | FASCETTA | FAIR LED | FIXATION DE CABLE | KABELBEFESTIGUNG |
| 5 | 12735599/0 | 1 | VITE | SCREW | VIS | SCHRAUBE |
| 6 | 12540260/0 | 1 | RONDELLA | WASHER | RONDELLE | SCHEIBE |
| 7 | 12691115/0 | 4 | VITE | SCREW | VIS | SCHRAUBE |
| 8 | 12154210/0 | 4 | DADO | NUT | ECROU | MUTTER |
| 9 | 25598051/0 | 1 | PROLUNGA SCARICO OLIO | OIL DISCHARGE EXTENSION | EXTENSION DECH. HUILE | ÖL ABFLUSS |
| 10 | 18737849/0 | 1 | TAPPO PROLUNGA | OIL CAP | BOUCHON HUILE | OELVERSCHLUSS |
| 11 | 18401001/1 | 1 | GUARNIZIONE | OIL SEAL | GARNITURE | DICHTUNG |
| 12 | 18738221/0 | 1 | TUBO SCARICO DESTRO | EXHAUST TUBE RIGHT | TUBE ECHAPPEMENT DROIT | ABGASUNGROHR, RECHTE |
| 13 | 18738222/0 | 1 | TUBO SCARICO SINISTRO | EXHAUST TUBE LEFT | TUBE ECHAPPEMENT GAU. | ABGASUNGROHR, LINKE |
| 31 | 82750003/0 | 1 | SILENZIATORE | MUFFLER | SILENCEUX | AUSPUFF |
| 32 | 12793102/0 | 2 | VITE | SCREW | VIS | SCHRAUBE |
| 33 | 12540260/0 | 2 | RONDELLA | WASHER | RONDELLE | SCHEIBE |
| 34 | 12360425/0 | 2 | DADO | NUT | ECROU | MUTTER |
| 35 | 82598005/2 | 1 | PROTEZIONE | GUARD | PROTECTION | SCHUTZE |
| 36 | 12792611/0 | 2 | VITE | SCREW | VIS | SCHRAUBE |
| 37 | 12583500/0 | 2 | GROWER | GROWER | GROWER | GROWER |

PER LA SOSTITUZIONE DELLE PARTI CONTRASSEGNALE CON «*» RIVOLGERSI AL SERVIZIO ASSISTENZA DEL COSTRUTTORE DEL MOTORE.
TO REPLACE THE PARTS MARKED «*» SEEK ASSISTANCE FROM THE ENGINE MANUFACTURER'S AFTER SALES SERVICE.
POUR LE REMPLACEMENT DES PIÈCES MARQUÉES AVEC «*» S'ADRESSER AU SERVICE APRÈS VENTES DU CONSTRUCTEUR DU MOTEUR.
ZUM AUSTAUSCH DER MIT «*» GEKENNZEICHNETEN TEILE, WENDEN SIE SICH AN DEN KUNDENDIENST DES HERSTELLERS DES MOTOR.

J JP JT JR JTP JB JX

92

92 hydro

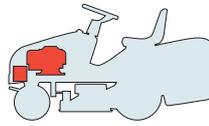

MOTORE
ENGINE
MOTEUR
MOTOR

KOHLER®

KOHLER 16 - 18 HP

2006

005d.0

1 / 1

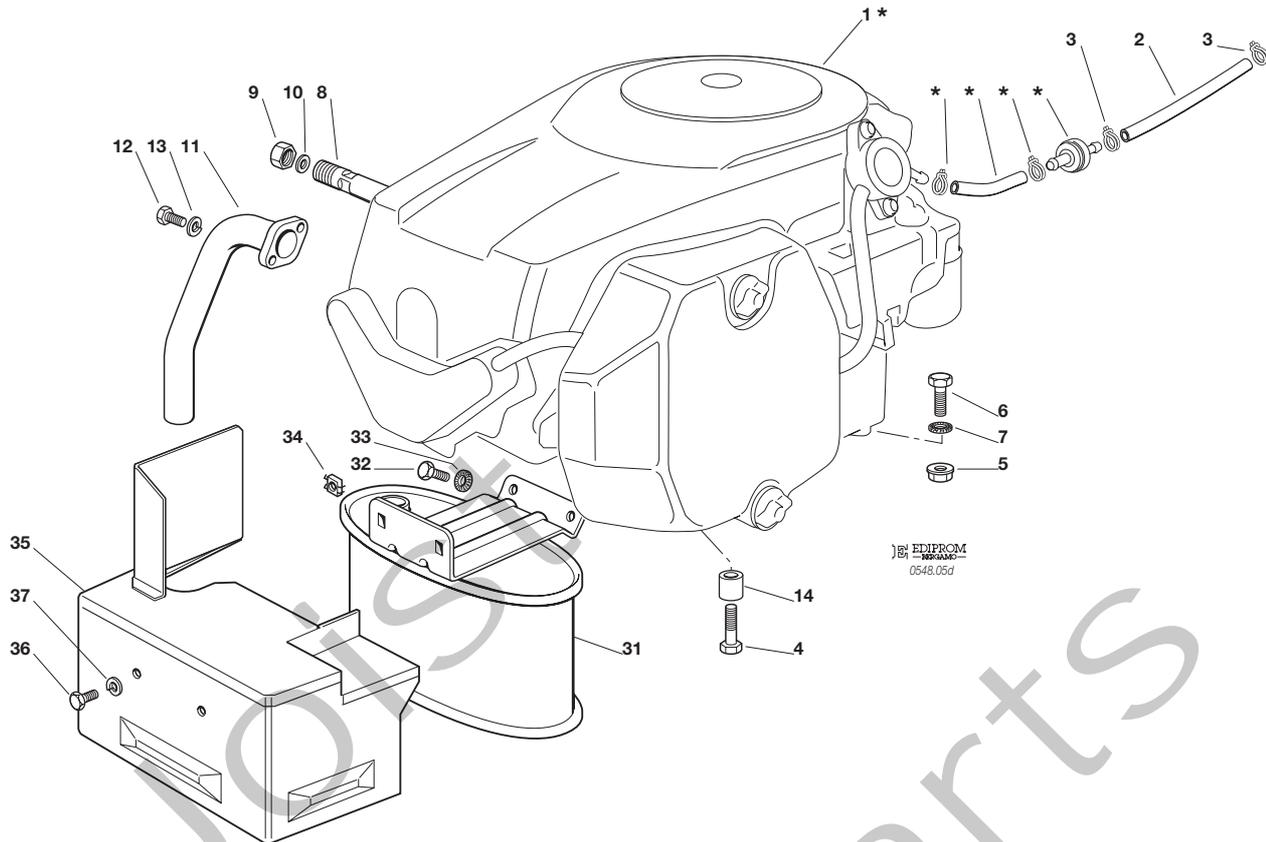

EDIPROM
0548.05d

| N. | CODE | Q.TY | DESCRIZIONE | DESCRIPTION | DESCRIPTION | BESCHREIBUNG |
|----|------------|------|-----------------------|-------------------------|-----------------------|------------------|
| 1* | — | 1 | MOTORE | ENGINE | MOTEUR | MOTOR |
| 2 | 25869016/1 | 1 | TUBO | TUBE | TUBE | ROHR |
| 3 | 18375051/1 | 2 | FASCETTA | FAIR LED | FIXATION DE CABLE | KABELBEFESTIGUNG |
| 4 | 12735108/0 | 3 | VITE | SCREW | VIS | SCHRAUBE |
| 5 | 12154210/0 | 1 | DADO | NUT | ECROU | MUTTER |
| 6 | 12691115/0 | 1 | VITE | SCREW | VIS | SCHRAUBE |
| 7 | 12540260/0 | 1 | RONDELLA | WASHER | RONDELLE | SCHEIBE |
| 8 | 27598060/0 | 1 | PROLUNGA SCARICO OLIO | OIL DISCHARGE EXTENSION | EXTENSION DECH. HUILE | ÖL ABFLUSS |
| 9 | 18737849/0 | 1 | TAPPO PROLUNGA | OIL CAP | BOUCHON HUILE | OELVERSCHLUSS |
| 10 | 18401001/1 | 1 | GUARNIZIONE | OIL SEAL | GARNITURE | DICHTUNG |
| 11 | 18738227/0 | 1 | TUBO SCARICO | EXHAUST TUBE | TUBE ECHAPPEMENT | ABGASUNGROHR |
| 12 | 12735530/0 | 2 | VITE | SCREW | VIS | SCHRAUBE |
| 13 | 12583500/0 | 2 | GROWER | GROWER | GROWER | GROWER |
| 14 | 25160035/0 | 3 | DISTANZIALE | SPACER | ENTRETOISE | ENTFERNUNGSSTÜCK |
| 31 | 82750004/0 | 1 | SILENZIATORE | MUFFLER | SILENCEUX | AUSPUFF |
| 32 | 12793102/0 | 2 | VITE | SCREW | VIS | SCHRAUBE |
| 33 | 12540260/0 | 2 | RONDELLA | WASHER | RONDELLE | SCHEIBE |
| 34 | 12360425/0 | 2 | DADO | NUT | ECROU | MUTTER |
| 35 | 82598029/0 | 1 | PROTEZIONE | GUARD | PROTECTION | SCHUTZE |
| 36 | 12792611/0 | 2 | VITE | SCREW | VIS | SCHRAUBE |
| 37 | 12583500/0 | 2 | GROWER | GROWER | GROWER | GROWER |

PER LA SOSTITUZIONE DELLE PARTI CONTRASSEGNALE CON «*» RIVOLGERSI AL SERVIZIO ASSISTENZA DEL COSTRUTTORE DEL MOTORE.
 TO REPLACE THE PARTS MARKED «*» SEEK ASSISTANCE FROM THE ENGINE MANUFACTURER'S AFTER SALES SERVICE.
 POUR LE REMPLACEMENT DES PIÈCES MARQUÉES AVEC «*» S'ADRESSER AU SERVICE APRÈS VENTES DU CONSTRUCTEUR DU MOTEUR.
 ZUM AUSTAUSCH DER MIT «*» GEKENNZEICHNETEN TEILE, WENDEN SIE SICH AN DEN KUNDENDIENST DES HERSTELLERS DES MOTOR.

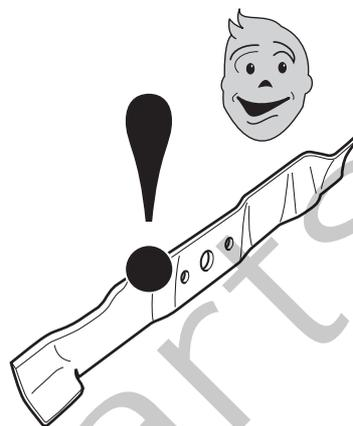
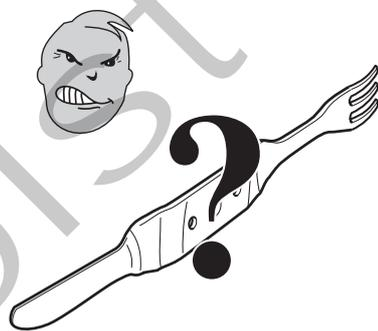

USARE SOLO RICAMBI ORIGINALI!
USE ONLY GENUINE SPARE PARTS!
UTILISER DES PIÈCES DE RECHANGE D'ORIGINE!
NUR ORIGINALERSATZTEILE VERWENDEN!

J JP JT JR JTP JB JX

92

92 hydro

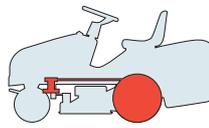

TRASMISSIONE
TRANSMISSION
TRANSMISSION
GETRIEBE

2006

006M.0

1 / 2

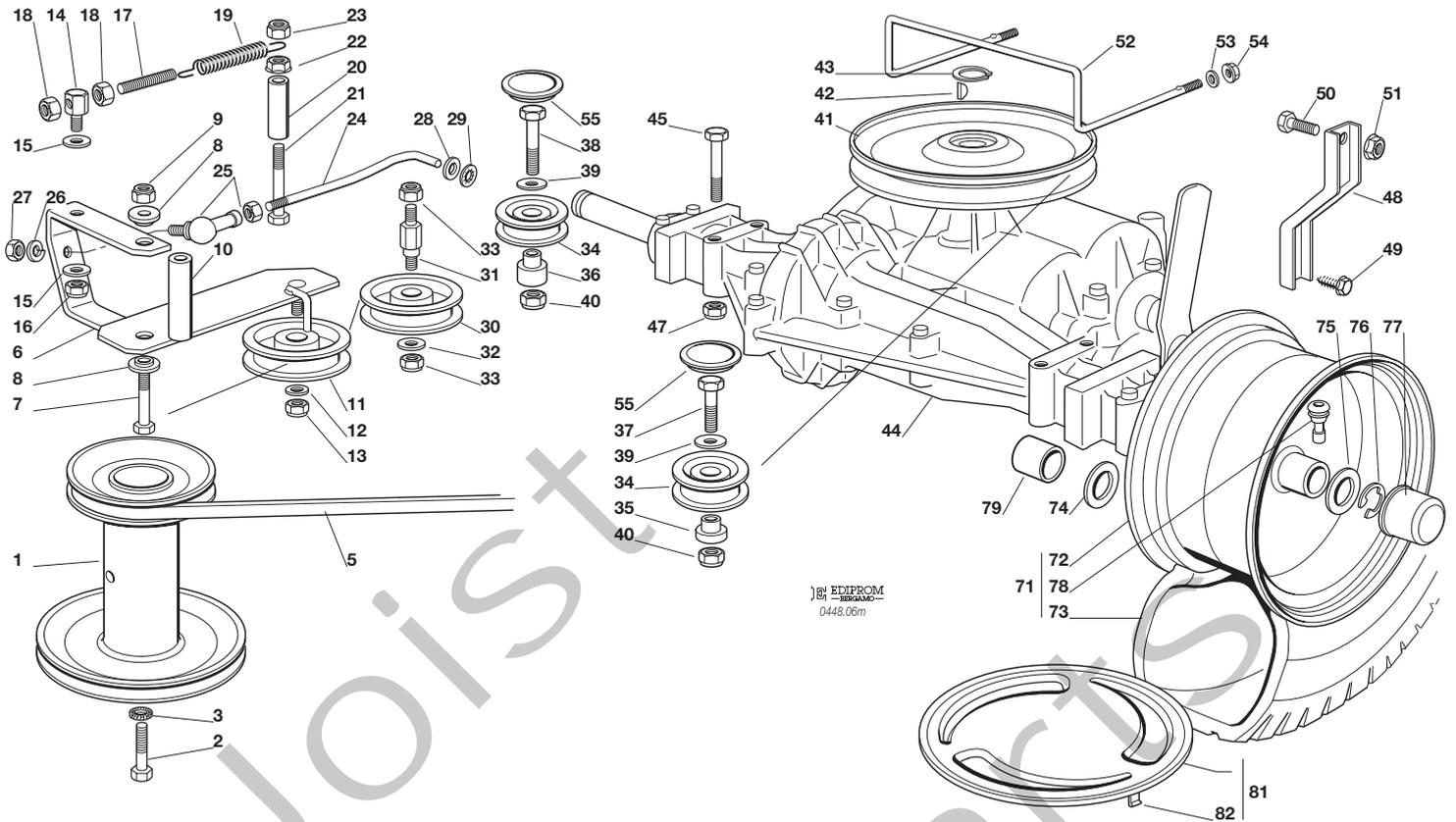

EDIPROM
0448.06m

| N. | CODE | Q.TY | DESCRIZIONE | DESCRIPTION | DESCRIPTION | BESCHREIBUNG |
|----|------------|------|--------------------|----------------|---------------------|------------------|
| 1 | 25601547/1 | 1 | PULEGGIA | PULLEY | POULIE | RIEMENSCHLEIBE |
| 2 | 12737310/0 | 1 | VITE | SCREW | VIS | SCHRAUBE |
| 3 | 12543000/0 | 1 | ROSETTA | WASHER | RONDELLE | SCHLEIBE |
| 5 | 35062000/1 | 1 | CINGHIA | BELT | COURROIE | RIEMEN |
| 6 | 82318133/0 | 1 | LEVA | LEVER | LEVIER | HEBEL |
| 7 | 12692080/0 | 1 | VITE | SCREW | VIS | SCHRAUBE |
| 8 | 25038002/1 | 2 | BOCCOLA | BUSH | DOUILLE | BÜCHSE |
| 9 | 12155000/0 | 1 | DADO | NUT | ECROU | MUTTER |
| 10 | 25160017/0 | 1 | DISTANZIALE | SPACER | ENTRETOISE | ENTFERNUNGSSTÜCK |
| 11 | 25601554/0 | 1 | PULEGGIA | PULLEY | POULIE | RIEMENSCHLEIBE |
| 12 | 12523060/0 | 1 | RONDELLA | WASHER | RONDELLE | SCHLEIBE |
| 13 | 12155000/0 | 1 | DADO | NUT | ECROU | MUTTER |
| 14 | 25510040/1 | 1 | PERNO | PIN | PIVOT | BOLZEN |
| 15 | 25670011/0 | 2 | RONDELLA | WASHER | RONDELLE | SCHLEIBE |
| 16 | 12155000/0 | 1 | DADO | NUT | ECROU | MUTTER |
| 17 | 25840005/0 | 1 | TIRANTE | TIE ROD | TIRANT | SPANNSTANGE |
| 18 | 12293200/0 | 2 | DADO | NUT | ECROU | MUTTER |
| 19 | 25430219/0 | 1 | MOLLA | SPRING | RESSORT | FEDER |
| 20 | 25160008/0 | 1 | DISTANZIALE | SPACER | ENTRETOISE | ENTFERNUNGSSTÜCK |
| 21 | 12692050/0 | 1 | VITE | SCREW | VIS | SCHRAUBE |
| 22 | 12293201/0 | 1 | DADO | NUT | ECROU | MUTTER |
| 23 | 12155000/0 | 1 | DADO | NUT | ECROU | MUTTER |
| 24 | 25840002/0 | 1 | TIRANTE | TIE ROD | TIRANT | SPANNSTANGE |
| 25 | 22746601/0 | 1 | SNODO | JOINT | JOINT | GELENK |
| 26 | 12583500/0 | 1 | GROWER | GROWER | GROWER | GROWER |
| 27 | 12293200/0 | 1 | DADO | NUT | ECROU | MUTTER |
| 28 | 12521350/0 | 1 | RONDELLA | WASHER | RONDELLE | SCHLEIBE |
| 29 | 12604899/0 | 1 | FISSATORE A CORONA | CROWN FASTENER | FIXATEUR A COURONNE | KRONESCHLEIBE |
| 30 | 25601555/0 | 1 | PULEGGIA | PULLEY | POULIE | RIEMENSCHLEIBE |
| 31 | 25510036/1 | 1 | PERNO | PIN | PIVOT | BOLZEN |
| 32 | 12523060/0 | 1 | RONDELLA | WASHER | RONDELLE | SCHLEIBE |





| N. | CODE | Q.TY | DESCRIZIONE | DESCRIPTION | DESCRIPTION | BESCHREIBUNG |
|-----|------------|------|----------------------------------------|----------------------------------------|----------------------------------------|----------------------------------------|
| 33 | 12155000/0 | 2 | DADO | NUT | ECROU | MUTTER |
| 34 | 25601570/0 | 2 | PULEGGIA | PULLEY | POULIE | RIEMENSCHLEIBE |
| 35 | 25160018/0 | 1 | DISTANZIALE SINISTRO | LEFT SPACER | ENTRETOISE GAUCHE | LINKER ENTFERNUNGSSTÜCK |
| 36 | 25160014/0 | 1 | DISTANZIALE DESTRO | RIGHT SPACER | ENTRETOISE DROITE | RECHTER ENTFERNUNGSSTÜCK |
| 37 | 12691100/0 | 1 | VITE SINISTRA | LEFT SCREW | VIS GAUCHE | LINKE SCHRAUBE |
| 38 | 12691200/0 | 1 | VITE DESTRA | RIGHT SCREW | VIS DROITE | RECHTE SCHRAUBE |
| 39 | 12523060/0 | 2 | RONDELLA | WASHER | RONDELLE | SCHEIBE |
| 40 | 12155000/0 | 2 | DADO | NUT | ECROU | MUTTER |
| 41 | 82601503/0 | 1 | PULEGGIA | PULLEY | POULIE | RIEMENSCHLEIBE |
| 42 | 12139430/0 | 1 | LINGUETTA | KEY | CLAVETTE | KEIL |
| 43 | 12608950/0 | 1 | ANELLO ELASTICO | SNAP RING | ANNEAU RESSORT | SPRENGRING |
| 44* | 18400910/2 | 1 | ASSE POSTERIORE | REAR AXLE | AXE ARRIERE | HINTERACHSE |
| | | | Tecumseh-Peerless MST 205-535 E | Tecumseh-Peerless MST 205-535 E | Tecumseh-Peerless MST 205-535 E | Tecumseh-Peerless MST 205-535 E |
| | 18400912/0 | 1 | ASSE POSTERIORE | REAR AXLE | AXE ARRIERE | HINTERACHSE |
| | | | Dana 4360-211 | Dana 4360-211 | Dana 4360-211 | Dana 4360-211 |
| 45 | 12691800/0 | 4 | VITE (Peerless) | SCREW (Peerless) | VIS (Peerless) | SCHRAUBE (Peerless) |
| | 12691900/0 | 4 | VITE (Dana) | SCREW (Dana) | VIS (Dana) | SCHRAUBE (Dana) |
| 47 | 12154210/0 | 4 | DADO | NUT | ECROU | MUTTER |
| 48 | 25774247/0 | 2 | STAFFA | CLAMP | ETRIER | BRIDE |
| 49 | 12735150/0 | 2 | VITE | SCREW | VIS | SCHRAUBE |
| 50 | 12792611/0 | 2 | VITE | SCREW | VIS | SCHRAUBE |
| 51 | 12293201/0 | 2 | DADO | NUT | ECROU | MUTTER |
| 52 | 25270303/2 | 1 | GUIDACINGHIA | BELT GUIDE | GUIDE DE COURROIRE | RIEMENFÜHRUNG |
| 53 | 12521330/0 | 2 | RONDELLA | WASHER | RONDELLE | SCHEIBE |
| 54 | 12292102/0 | 2 | DADO | NUT | ECROU | MUTTER |
| 55 | 25109521/1 | 2 | COPERCHIO | COVER | COUVERCLE | DECKEL |
| 71 | 82680003/0 | 2 | RUOTA POSTERIORE | REAR WHEEL | ROUE ARRIERE | HINTERRAD |
| | 82680006/0 | | TURF SAVER CARLISLE | TURF SAVER CARLISLE | TURF SAVER CARLISLE | TURF SAVER CARLISLE |
| | | | DELI TIRE | DELI TIRE | DELI TIRE | DELI TIRE |
| 72 | 82000592/0 | 2 | CERCHIO RUOTA | RIMM | BANDAGE ROUE | HINTERRAD FELGER |
| 73 | 25590001/0 | 2 | PNEUMATICO | SHOE | PNEU | REIFEN |
| | 25590003/0 | | TURF SAVER CARLISLE | TURF SAVER CARLISLE | TURF SAVER CARLISLE | TURF SAVER CARLISLE |
| | | | DELI TIRE | DELI TIRE | DELI TIRE | DELI TIRE |
| 74 | 12521410/0 | 2-4 | RONDELLA | WASHER | RONDELLE | SCHEIBE |
| 75 | 25670005/1 | 2 | RONDELLA | WASHER | RONDELLE | SCHEIBE |
| 76 | 12001010/0 | 2 | ANELLO ELASTICO | SNAP RING | ANNEAU RESSORT | SPRENGRING |
| 77 | 22110230/0 | 2 | COPRIMOZZO | HUB COVER | COUVRE MOYEU | NABEDECKEL |
| 78 | 25950000/0 | 2 | VALVOLA | VALVE | SOUPAPE | VENTIL |
| 79 | 25160034/0 | 2 | DISTANZIALE (Dana) | SPACER (Dana) | ENTRETOISE (Dana) | ENTFERNUNGSSTÜCK (Dana) |
| 81 | 82110253/0 | 2 | COPRIRUOTA POST. | REAR WHEEL DECK | COUVRE ROUE POST. | HINTERRADDECKEL |
| 82 | 25430209/0 | 8 | MOLLA AGGANCI | SPRING | RESSORT | FEDER |

PER LA SOSTITUZIONE DELLE PARTI CONTRASSEGNALE CON «*» RIVOLGERSI AL SERVIZIO ASSISTENZA DEL COSTRUTTORE DELLA TRASMISSIONE.
 TO REPLACE THE PARTS MARKED «*» SEEK ASSISTANCE FROM THE TRANSMISSION MANUFACTURER'S AFTER SALES SERVICE.
 POUR LE REMPLACEMENT DES PIÈCES MARQUÉES AVEC «*» S'ADRESSER AU SERVICE APRÈS VENTES DU CONSTRUCTEUR DE LA TRANSMISSION.
 ZUM AUSTAUSCH DER MIT «*» GEKENNZEICHNETEN TEILE, WENDEN SIE SICH AN DEN KUNDENDIENST DES HERSTELLERS DES ANTRIEBS.

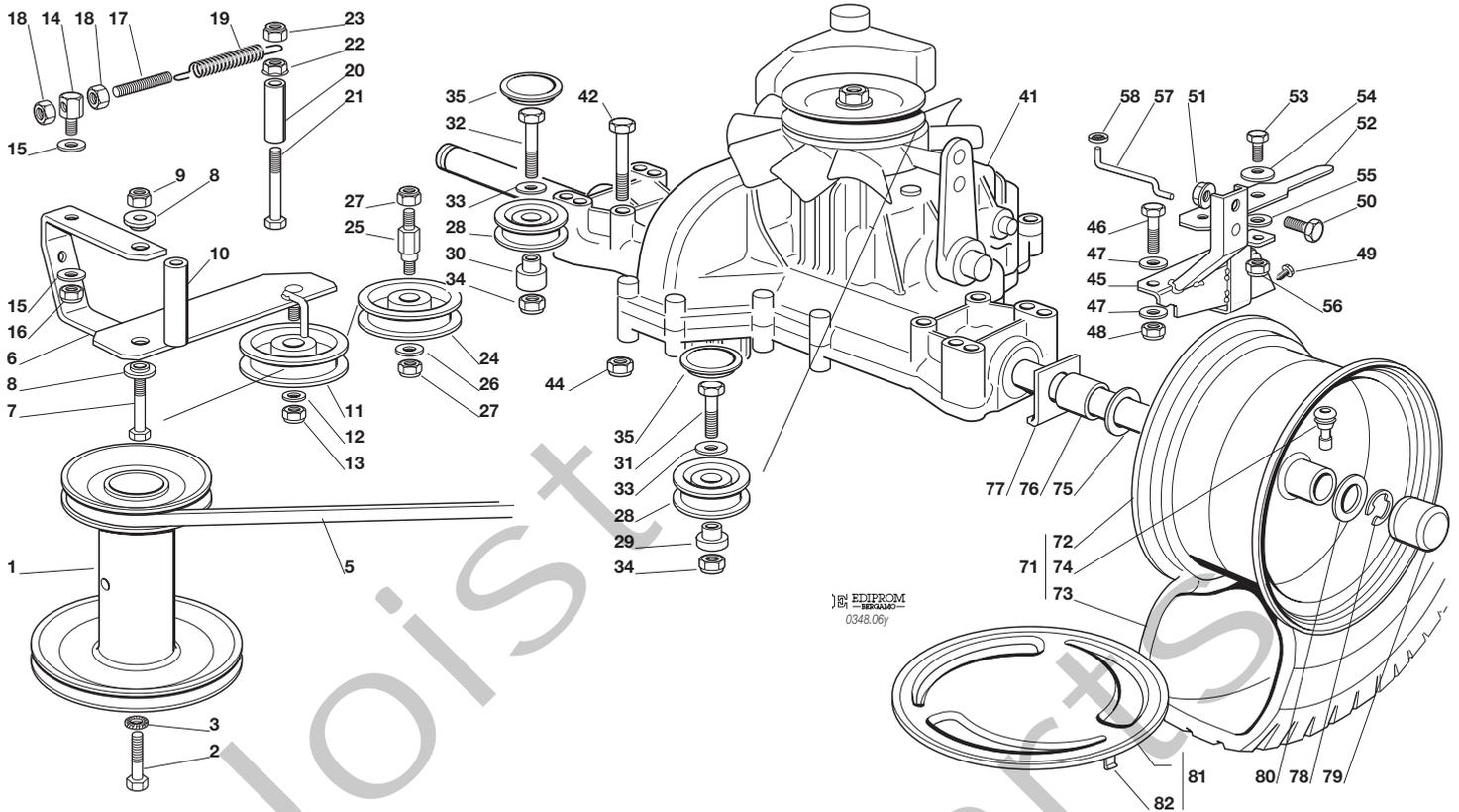
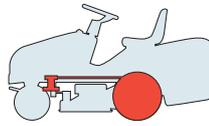

EDIPROM
SERVIZIO
0348.06y

| N. | CODE | Q.TY | DESCRIZIONE | DESCRIPTION | DESCRIPTION | BESCHREIBUNG |
|----|------------|------|----------------------|--------------|-------------------|--------------------------|
| 1 | 25601548/1 | 1 | PULEGGIA | PULLEY | POULIE | RIEMENSCHLEIBE |
| 2 | 12737310/0 | 1 | VITE | SCREW | VIS | SCHRAUBE |
| 3 | 12543000/0 | 1 | ROSETTA | WASHER | RONDELLE | SCHEIBE |
| 5 | 35061980/0 | 1 | CINGHIA | BELT | COURROIE | RIEMEN |
| 6 | 82318133/0 | 1 | LEVA | LEVER | LEVIER | HEBEL |
| 7 | 12692080/0 | 1 | VITE | SCREW | VIS | SCHRAUBE |
| 8 | 25038002/1 | 2 | BOCCOLA | BUSH | DOUILLE | BÜCHSE |
| 9 | 12155000/0 | 1 | DADO | NUT | ECROU | MUTTER |
| 10 | 25160017/0 | 1 | DISTANZIALE | SPACER | ENTRETOISE | ENTFERNUNGSSTÜCK |
| 11 | 25601554/0 | 1 | PULEGGIA | PULLEY | POULIE | RIEMENSCHLEIBE |
| 12 | 12523060/0 | 1 | RONDELLA | WASHER | RONDELLE | SCHEIBE |
| 13 | 12155000/0 | 1 | DADO | NUT | ECROU | MUTTER |
| 14 | 25510040/1 | 1 | PERNO | PIN | PIVOT | BOLZEN |
| 15 | 25670011/0 | 2 | RONDELLA | WASHER | RONDELLE | SCHEIBE |
| 16 | 12155000/0 | 1 | DADO | NUT | ECROU | MUTTER |
| 17 | 25840005/0 | 1 | TIRANTE | TIE ROD | TIRANT | SPANNSTANGE |
| 18 | 12293200/0 | 2 | DADO | NUT | ECROU | MUTTER |
| 19 | 25430219/0 | 1 | MOLLA | SPRING | RESSORT | FEDER |
| 20 | 25160008/0 | 1 | DISTANZIALE | SPACER | ENTRETOISE | ENTFERNUNGSSTÜCK |
| 21 | 12692050/0 | 1 | VITE | SCREW | VIS | SCHRAUBE |
| 22 | 12293201/0 | 1 | DADO | NUT | ECROU | MUTTER |
| 23 | 12155000/0 | 1 | DADO | NUT | ECROU | MUTTER |
| 24 | 25601555/0 | 1 | PULEGGIA | PULLEY | POULIE | RIEMENSCHLEIBE |
| 25 | 25510036/1 | 1 | PERNO | PIN | PIVOT | BOLZEN |
| 26 | 12523060/0 | 1 | RONDELLA | WASHER | RONDELLE | SCHEIBE |
| 27 | 12155000/0 | 2 | DADO | NUT | ECROU | MUTTER |
| 28 | 25601570/0 | 2 | PULEGGIA | PULLEY | POULIE | RIEMENSCHLEIBE |
| 29 | 25160030/0 | 1 | DISTANZIALE SINISTRO | LEFT SPACER | ENTRETOISE GAUCHE | LINKER ENTFERNUNGSSTÜCK |
| 30 | 25160024/1 | 1 | DISTANZIALE DESTRO | RIGHT SPACER | ENTRETOISE DROITE | RECHTER ENTFERNUNGSSTÜCK |





| N. | CODE | Q.TY | DESCRIZIONE | DESCRIPTION | DESCRIPTION | BESCHREIBUNG |
|-----|------------|------|------------------------------------------|------------------------------------|--------------------------------------|--------------------------------------|
| 31 | 12691115/0 | 1 | VITE SINISTRA | LEFT SCREW | VIS GAUCHE | LINKE SCHRAUBE |
| 32 | 12691400/0 | 1 | VITE DESTRA | RIGHT SCREW | VIS DROITE | RECHTE SCHRAUBE |
| 33 | 12523060/0 | 2 | RONDELLA | WASHER | RONDELLE | SCHEIBE |
| 34 | 12155000/0 | 2 | DADO | NUT | ECROU | MUTTER |
| 35 | 25109521/1 | 2 | COPERCHIO | COVER | COUVERCLE | DECKEL |
| 41* | 18400960/0 | 1 | ASSE POSTERIORE Tuff Torq K46S | REAR AXLE Tuff Torq K46S | AXE ARRIERE Tuff Torq K46S | HINTERACHSE Tuff Torq K46S |
| 42 | 12691800/0 | 4 | VITE | SCREW | VIS | SCHRAUBE |
| 44 | 12154210/0 | 4 | DADO | NUT | ECROU | MUTTER |
| 45 | 82785117/0 | 1 | SUPPORTO | SUPPORT | SUPPORT | HALTER |
| 46 | 12691200/0 | 1 | VITE | SCREW | VIS | SCHRAUBE |
| 47 | 12521350/0 | 2 | RONDELLA | WASHER | RONDELLE | SCHEIBE |
| 48 | 12155000/0 | 1 | DADO | NUT | ECROU | MUTTER |
| 49 | 12735120/0 | 2 | VITE | SCREW | VIS | SCHRAUBE |
| 50 | 12792611/0 | 1 | VITE | SCREW | VIS | SCHRAUBE |
| 51 | 12293201/0 | 1 | DADO | NUT | ECROU | MUTTER |
| 52 | 25318157/0 | 1 | LEVA | LEVER | LEVIER | HEBEL |
| 53 | 12793102/0 | 1 | VITE | SCREW | VIS | SCHRAUBE |
| 54 | 12369500/0 | 1 | DISCO ELASTICO | ELASTIC WASHER | DISQUE ELASTIQUE | FEDERSCHEIBE |
| 55 | 25670011/0 | 1 | RONDELLA | WASHER | RONDELLE | SCHEIBE |
| 56 | 12155000/0 | 1 | DADO | NUT | ECROU | MUTTER |
| 57 | 25033033/0 | 1 | ASTA | ROD | BARRE | STANGE |
| 58 | 12604896/0 | 1 | FISSATORE A CORONA | CROWN FASTENER | FIXATEUR A COURONNE | KRONESCHEIBE |
| 71 | 82680003/0 | 2 | RUOTA POSTERIORE TURF SAVER CARLISLE | REAR WHEEL TURF SAVER CARLISLE | ROUE ARRIERE TURF SAVER CARLISLE | HINTERRAD TURF SAVER CARLISLE |
| | 82680006/0 | | DELI TIRE | DELI TIRE | DELI TIRE | DELI TIRE |
| 72 | 82000592/0 | 2 | CERCHIO RUOTA | RIMM | BANDAGE ROUE | HINTRERRAD FELGER |
| 73 | 25590001/0 | 2 | PNEUMATICO TURF SAVER CARLISLE | SHOE TURF SAVER CARLISLE | PNEU TURF SAVER CARLISLE | REIFEN TURF SAVER CARLISLE |
| | 25590003/0 | | DELI TIRE | DELI TIRE | DELI TIRE | DELI TIRE |
| 74 | 25950000/0 | 2 | VALVOLA | VALVE | SOUPAPE | VENTIL |
| 75 | 12521410/0 | 2-4 | RONDELLA | WASHER | RONDELLE | SCHEIBE |
| 76 | 25160031/0 | 2 | DISTANZIALE | SPACER | ENTRETOISE | ENTFERNUNGSSTÜCK |
| 77 | 25670017/0 | 2 | RONDELLA | WASHER | RONDELLE | SCHEIBE |
| 78 | 12001010/0 | 2 | ANELLO ELASTICO | SNAP RING | ANNEAU RESSORT | SPRENGRING |
| 79 | 22110230/0 | 2 | COPRIMOZZO | HUB COVER | COUVRE MOYEU | NABEDECKEL |
| 80 | 25670005/1 | 2 | RONDELLA | WASHER | RONDELLE | SCHEIBE |
| 81 | 82110253/0 | 2 | COPRIRUOTA POST. | REAR WHEEL DECK | COUVRE ROUE POST. | HINTERRADDECKEL |
| 82 | 25430209/0 | 8 | MOLLA AGGANCI | SPRING | RESSORT | FEDER |

PER LA SOSTITUZIONE DELLE PARTI CONTRASSEGNAE CON «*» RIVOLGERSI AL SERVIZIO ASSISTENZA DEL COSTRUTTORE DELLA TRASMISSIONE.
 TO REPLACE THE PARTS MARKED «*» SEEK ASSISTANCE FROM THE TRANSMISSION MANUFACTURER'S AFTER SALES SERVICE.
 POUR LE REMPLACEMENT DES PIÈCES MARQUÉES AVEC «*» S'ADRESSER AU SERVICE APRÈS VENTES DU CONSTRUCTEUR DE LA TRANSMISSION.
 ZUM AUSTAUSCH DER MIT «*» GEKENNZEICHNETEN TEILE, WENDEN SIE SICH AN DEN KUNDENDIENST DES HERSTELLERS DES ANTRIEBS.

J JP JT JR JTP JB JX

92

92 hydro

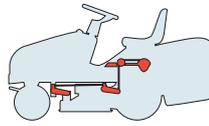

SOLLEVAMENTO PIATTO DI TAGLIO
CUTTING PLATE LIFTING
SOULEVEMENT PLATEAU DE COUPE
SCHNEIDWERKZEUG AUFHEBESATZ

2006

007.0

1 / 2

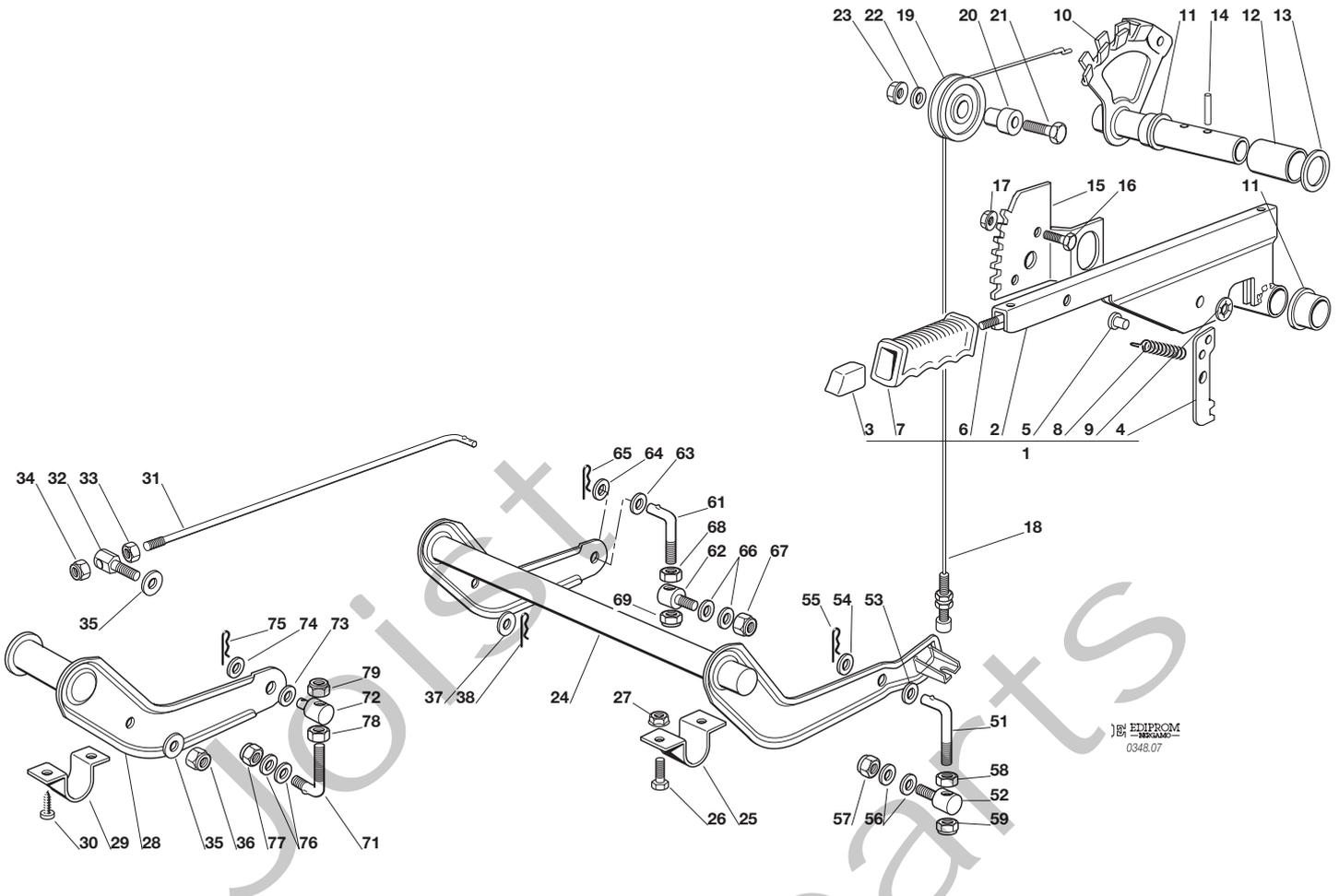

EDIPROM
0348.07

| N. | CODE | Q.TY | DESCRIZIONE | DESCRIPTION | DESCRIPTION | BESCHREIBUNG |
|----|------------|------|--------------------|-------------------|-------------------|-------------------------------------|
| 1 | 82300002/1 | 1 | ASSIEME LEVA (2÷9) | LEVER ASS.Y (2÷9) | ENS. LEVIER (2÷9) | SCHNEIDWERKZEUG AUFHEBENHEBEL (2÷9) |
| 2 | 82318139/0 | 1 | LEVA | LEVER | LEVIER | HEBEL |
| 3 | 25605000/1 | 1 | PULSANTE | BUTTON | POUSSOIR | DRUCKKNOPF |
| 4 | 25470901/0 | 1 | NASELLO | DOG | DECLIC | NASE |
| 5 | 25510011/0 | 1 | PERNO | PIN | PIVOT | BOLZEN |
| 6 | 25033002/0 | 1 | ASTA | ROD | TIGE | STAB |
| 7 | 25394504/1 | 1 | MANOPOLA | KNOB | POIGNEE | GRIFF |
| 8 | 25430208/0 | 1 | MOLLA | SPRING | RESSORT | FEDER |
| 9 | 12604899/0 | 1 | RONDELLA | WASHER | RONDELLE | SCHEIBE |
| 10 | 82000403/0 | 1 | ASSE | AXLE | AXE | ACHSE |
| 11 | 22034523/0 | 2 | BOCCOLA | BUSH | DOUILLE | BÜCHSE |
| 12 | 25160013/0 | 1 | DISTANZIALE | SPACER | ENTRETOISE | ENTFERNUNGSSTÜCK |
| 13 | 12521410/0 | 1 | RONDELLA | WASHER | RONDELLE | SCHEIBE |
| 14 | 12620206/0 | 2 | SPINA | PIN | GOUPILLE | STIFT |
| 15 | 25735506/1 | 1 | SETTORE | SECTOR | SECTEUR | SEKTOR |
| 16 | 12792611/0 | 2 | VITE | SCREW | VIS | SCHRAUBE |
| 17 | 12293201/0 | 2 | DADO | NUT | ECROU | MUTTER |
| 18 | 82004603/0 | 1 | FILO | WIRE | FIL | KABEL |
| 19 | 25601557/0 | 1 | PULEGGIA | PULLLEY | POULIE | RIEMENSCHIEBE |
| 20 | 25510032/0 | 1 | PERNO | PIN | PIVOT | BOLZEN |
| 21 | 12691400/0 | 1 | VITE | SCREW | VIS | SCHRAUBE |
| 22 | 12523060/0 | 1 | RONDELLA | WASHER | RONDELLE | SCHEIBE |
| 23 | 12293201/0 | 1 | DADO | NUT | ECROU | MUTTER |
| 24 | 82000381/2 | 1 | ASSE SOLLEVAMENTO | AXLE | AXE | ACHSE |
| 25 | 25547037/1 | 2 | PIASTRINA | PLATE | PLAQUE | PLATTE |
| 26 | 12791011/0 | 4 | VITE | SCREW | VIS | SCHRAUBE |
| 27 | 12292102/0 | 4 | DADO | NUT | ECROU | MUTTER |
| 28 | 82318137/0 | 1 | LEVA | LEVER | LEVIER | HEBEL |
| 29 | 25547041/0 | 2 | PIASTRINA | PLATE | PLAQUE | PLATTE |
| 30 | 12731601/0 | 4 | VITE | SCREW | VIS | SCHRAUBE |





| N. | CODE | Q.TY | DESCRIZIONE | DESCRIPTION | DESCRIPTION | BESCHREIBUNG |
|----|------------|------|-------------|-------------|-------------|--------------|
| 31 | 25033013/0 | 1 | ASTA | ROD | TIGE | STAB |
| 32 | 25510040/1 | 1 | PERNO | PIN | PIVOT | BOLZEN |
| 33 | 12293200/0 | 1 | DADO | NUT | ECROU | MUTTER |
| 34 | 12155000/0 | 1 | DADO | NUT | ECROU | MUTTER |
| 35 | 25670011/0 | 2 | RONDELLA | WASHER | RONDELLE | SCHEIBE |
| 36 | 12155000/0 | 1 | DADO | NUT | ECROU | MUTTER |
| 37 | 12521350/0 | 1 | RONDELLA | WASHER | RONDELLE | SCHEIBE |
| 38 | 24487997/0 | 1 | COPPIGLIA | COTTER PIN | GOUPILLE | SPLIT |
| 51 | 25840003/2 | 1 | TIRANTE | TIE ROD | TIRANT | SPANNSTANGE |
| 52 | 25510024/0 | 1 | PERNO | PIN | PIVOT | BOLZEN |
| 53 | 12521360/0 | 1 | RONDELLA | WASHER | RONDELLE | SCHEIBE |
| 54 | 25670008/1 | 1 | RONDELLA | WASHER | RONDELLE | SCHEIBE |
| 55 | 24487997/0 | 1 | COPPIGLIA | COTTER PIN | GOUPILLE | SPLIT |
| 56 | 25670008/1 | 2 | RONDELLA | WASHER | RONDELLE | SCHEIBE |
| 57 | 12156602/0 | 1 | DADO | NUT | ECROU | MUTTER |
| 58 | 12295200/0 | 1 | DADO | NUT | ECROU | MUTTER |
| 59 | 12156602/0 | 1 | DADO | NUT | ECROU | MUTTER |
| 61 | 25840003/2 | 1 | TIRANTE | TIE ROD | TIRANT | SPANNSTANGE |
| 62 | 25510024/0 | 1 | PERNO | PIN | PIVOT | BOLZEN |
| 63 | 12521360/0 | 1 | RONDELLA | WASHER | RONDELLE | SCHEIBE |
| 64 | 25670008/1 | 1 | RONDELLA | WASHER | RONDELLE | SCHEIBE |
| 65 | 24487997/0 | 1 | COPPIGLIA | COTTER PIN | GOUPILLE | SPLIT |
| 66 | 25670008/1 | 2 | RONDELLA | WASHER | RONDELLE | SCHEIBE |
| 67 | 12156602/0 | 1 | DADO | NUT | ECROU | MUTTER |
| 68 | 12295200/0 | 1 | DADO | NUT | ECROU | MUTTER |
| 69 | 12156602/0 | 1 | DADO | NUT | ECROU | MUTTER |
| 71 | 25840014/0 | 1 | TIRANTE | TIE ROD | TIRANT | SPANNSTANGE |
| 72 | 25510069/0 | 1 | PERNO | PIN | PIVOT | BOLZEN |
| 73 | 25670008/1 | 1 | RONDELLA | WASHER | RONDELLE | SCHEIBE |
| 74 | 12521360/0 | 1 | RONDELLA | WASHER | RONDELLE | SCHEIBE |
| 75 | 24487997/0 | 1 | COPPIGLIA | COTTER PIN | GOUPILLE | SPLIT |
| 76 | 25670008/1 | 2 | RONDELLA | WASHER | RONDELLE | SCHEIBE |
| 77 | 12156602/0 | 1 | DADO | NUT | ECROU | MUTTER |
| 78 | 12295200/0 | 1 | DADO | NUT | ECROU | MUTTER |
| 79 | 12156602/0 | 1 | DADO | NUT | ECROU | MUTTER |

J JP JT JR JTP JB JX

92

92 hydro

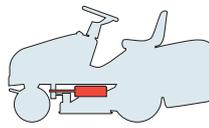

PIATTO DI TAGLIO (1)
CUTTING PLATE (1)
PLATEAU DE COUPE (1)
SCHNEIDWERKZEUG (1)

2006

008.0

1 / 2

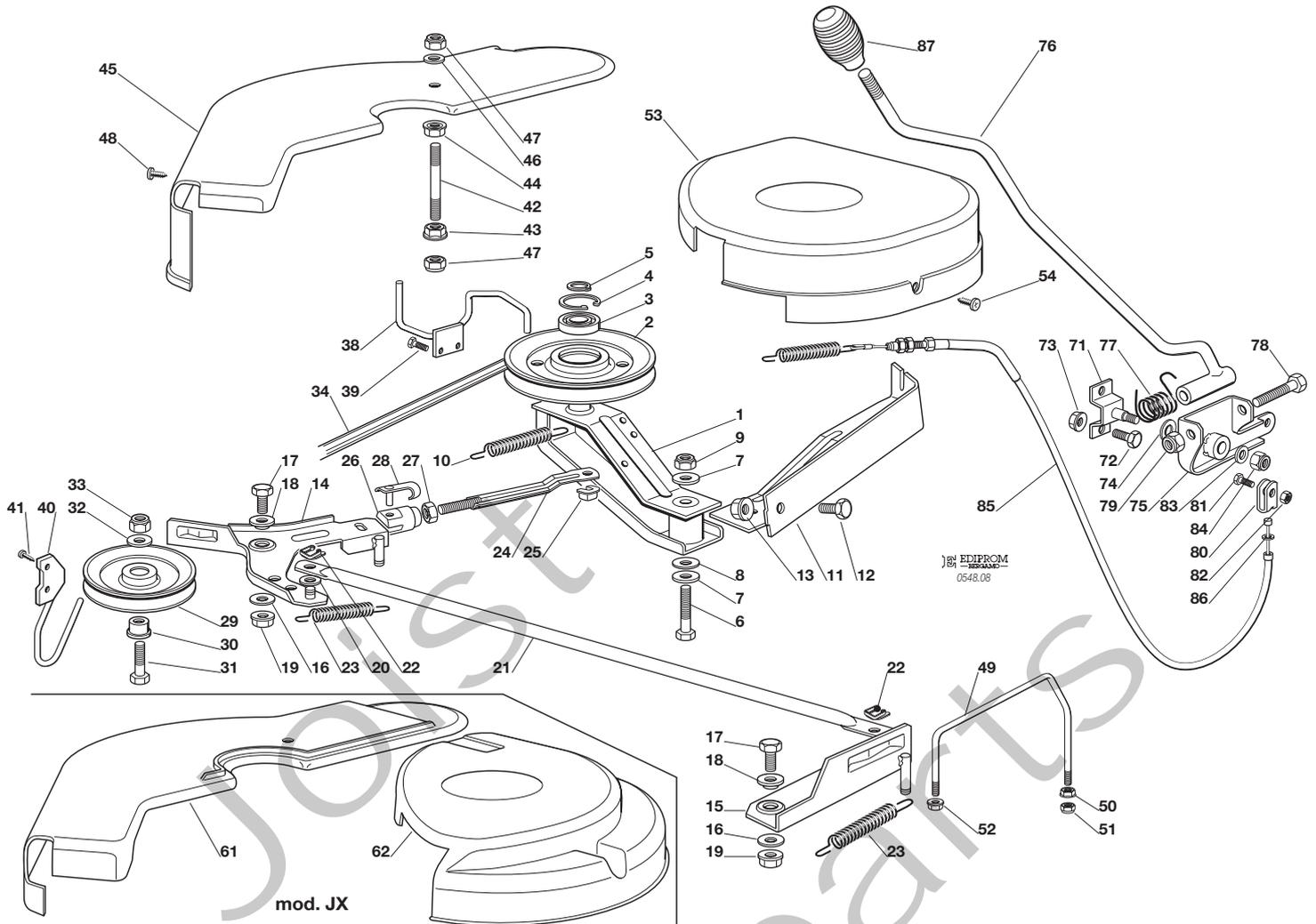

| N. | CODE | Q.TY | DESCRIZIONE | DESCRIPTION | DESCRIPTION | BESCHREIBUNG |
|----|------------|------|-----------------|-------------|----------------|------------------|
| 1 | 82318141/2 | 1 | LEVA | LEVER | LEVIER | HEBEL |
| 2 | 25601564/0 | 1 | PULEGGIA | PULLEY | POULIE | RIEMENSCHLEIBE |
| 3 | 19216033/1 | 1 | CUSCINETTO | BEARING | ROULEMENT | KUEGELLAGER |
| 4 | 12610800/0 | 1 | ANELLO ELASTICO | SNAP RING | ANNEAU RESSORT | SPRENGRING |
| 5 | 12609200/0 | 1 | ANELLO ELASTICO | SNAP RING | ANNEAU RESSORT | SPRENGRING |
| 6 | 12691700/0 | 1 | VITE | SCREW | VIS | SCHRAUBE |
| 7 | 12523070/0 | 2 | RONDELLA | WASHER | RONDELLE | SCHEIBE |
| 8 | 22672152/0 | 1 | RONDELLA | WASHER | RONDELLE | SCHEIBE |
| 9 | 12155000/0 | 1 | DADO | NUT | ECROU | MUTTER |
| 10 | 22450500/0 | 1 | MOLLA | SPRING | RESSORT | FEDER |
| 11 | 82774215/2 | 1 | STAFFA | CLAMP | BRIDE | BRIDE |
| 12 | 12792611/0 | 1 | VITE | SCREW | VIS | SCHRAUBE |
| 13 | 12293201/0 | 1 | DADO | NUT | ECROU | MUTTER |
| 14 | 82318143/2 | 1 | LEVA DESTRA | RIGHT LEVER | LEVIER DROITE | RECHTE HEBEL |
| 15 | 82318148/0 | 1 | LEVA SINISTRA | LEFT LEVER | LEVIER GAUCHE | LINKE HEBEL |
| 16 | 22672152/0 | 2 | RONDELLA | WASHER | RONDELLE | SCHEIBE |
| 17 | 12792611/0 | 2 | VITE | SCREW | VIS | SCHRAUBE |
| 18 | 22041980/0 | 2 | BUSSOLA | BUSH | DOUILLE | BÜCHSE |
| 19 | 12293201/0 | 2 | DADO | NUT | ECROU | MUTTER |
| 20 | 25670011/0 | 1 | RONDELLA | WASHER | RONDELLE | SCHEIBE |
| 21 | 25033024/0 | 1 | ASTA | ROD | TIGE | TAB |
| 22 | 12436050/0 | 2 | PIASTRINA | PLATE | PLAQUE | PLATTE |
| 23 | 25430229/1 | 2 | MOLLA | SPRING | RESSORT | FEDER |
| 24 | 82000499/0 | 1 | ASTA | ROD | TIGE | STAB |
| 25 | 12436050/0 | 1 | PIASTRINA | PLATE | PLAQUE | PLATTE |
| 26 | 18399000/0 | 1 | FORCELLA | FORK | FOURCHE | GABEL |
| 27 | 12292100/0 | 1 | DADO | NUT | ECROU | MUTTER |
| 28 | 18210200/0 | 1 | CLIP | CLIP | CLIP | SPERRBOLZEN |
| 29 | 25601555/0 | 1 | PULEGGIA | PULLEY | POULIE | RIEMENSCHLEIBE |
| 30 | 25160007/0 | 1 | DISTANZIALE | SPACER | ENTRETOISE | ENTFERNUNGSSTÜCK |
| 31 | 12691100/0 | 1 | VITE | SCREW | VIS | SCHRAUBE |





| N. | CODE | Q.TY | DESCRIZIONE | DESCRIPTION | DESCRIPTION | BESCHREIBUNG |
|----|------------|------|--------------|-------------|--------------------|---------------|
| 32 | 12523060/0 | 1 | RONDELLA | WASHER | RONDELLE | SCHEIBE |
| 33 | 12155000/0 | 1 | DADO | NUT | ECROU | MUTTER |
| 34 | 35065700/0 | 1 | CINGHIA | BELT | COURROIRE | KEILRIEMEN |
| 38 | 25270301/0 | 1 | GUIDACINGHIA | BELT GUIDE | GUIDE DE COURROIRE | RIEMENFÜHRUNG |
| 39 | 12729601/1 | 2 | VITE | SCREW | VIS | SCHRAUBE |
| 40 | 25270304/1 | 1 | GUIDACINGHIA | BELT GUIDE | GUIDE DE COURROIRE | RIEMENFÜHRUNG |
| 41 | 12731601/0 | 2 | VITE | SCREW | VIS | SCHRAUBE |
| 42 | 25580007/0 | 1 | PRIGIONIERO | STUD SCREW | PRISONNIER | STIFTSCHIEBE |
| 43 | 12293201/0 | 1 | DADO | NUT | ECROU | MUTTER |
| 44 | 12293201/0 | 1 | DADO | NUT | ECROU | MUTTER |
| 45 | 25060102/0 | 1 | CARTER | GUARD | CARTER | BLECH |
| 46 | 12523060/0 | 1 | RONDELLA | WASHER | RONDELLE | SCHEIBE |
| 47 | 12155000/0 | 2 | DADO | NUT | ECROU | MUTTER |
| 48 | 12735110/0 | 2 | VITE | SCREW | VIS | SCHRAUBE |
| 49 | 25270316/0 | 1 | GUIDACINGHIA | BELT GUIDE | GUIDE DE COURROIRE | RIEMENFÜHRUNG |
| 50 | 12293201/0 | 1 | DADO | NUT | ECROU | MUTTER |
| 51 | 12155000/0 | 1 | DADO | NUT | ECROU | MUTTER |
| 52 | 12292102/0 | 1 | DADO | NUT | ECROU | MUTTER |
| 53 | 25060103/0 | 1 | CARTER | GUARD | CARTER | BLECH |
| 54 | 12735110/0 | 2 | VITE | SCREW | VIS | SCHRAUBE |

Nei modelli JX:**For models JX:****Dans les modèles JX:****Bei Modellen JX:**

| | | | | | | |
|----|------------|---|------------|------------------|--------------------|--------------|
| 61 | 25060111/0 | 1 | CARTER | GUARD | CARTER | BLECH |
| 62 | 25060112/0 | 1 | CARTER | GUARD | CARTER | BLECH |
| 71 | 82785073/0 | 1 | SUPPORTO | SUPPORT | SUPPORT | HALTER |
| 72 | 12792611/0 | 2 | VITE | SCREW | VIS | SCHRAUBE |
| 73 | 12293201/0 | 2 | DADO | NUT | ECROU | MUTTER |
| 74 | 22672151/0 | 1 | RONDELLA | WASHER | RONDELLE | SCHEIBE |
| 75 | 82774204/1 | 1 | STAFFA | CLAMP | BRIDE | BRIDE |
| 76 | 82318135/0 | 1 | LEVA | LEVER | LEVIER | HEBEL |
| 77 | 25430227/0 | 1 | MOLLA | SPRING | RESSORT | FEDER |
| 78 | 12692050/0 | 1 | VITE | SCREW | VIS | SCHRAUBE |
| 79 | 12155000/0 | 1 | DADO | NUT | ECROU | MUTTER |
| 80 | 22061337/0 | 1 | CAVALLOTTO | CONNECTING PLATE | PAQUE DE CONNEXION | BUGEL BOLZEN |
| 81 | 12791213/1 | 1 | VITE | SCREW | VIS | SCHRAUBE |
| 82 | 12154510/0 | 1 | DADO | NUT | ECROU | MUTTER |
| 83 | 12523060/0 | 1 | RONDELLA | WASHER | RONDELLE | SCHEIBE |
| 84 | 12155010/0 | 1 | DADO | NUT | ECROU | MUTTER |
| 85 | 82004604/3 | 1 | FILO | WIRE | FIL | KABEL |
| 86 | 12523060/0 | 1 | RONDELLA | WASHER | RONDELLE | SCHEIBE |
| 87 | 25394510/0 | 1 | MANOPOLA | KNOB | POIGNEE | GRIFF |

J JP JT JR JTP JB JX

92

92 hydro

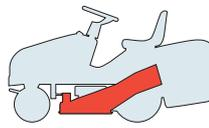

PIATTO DI TAGLIO (2)
CUTTING PLATE (2)
PLATEAU DE COUPE (2)
SCHNEIDWERKZEUG (2)

2006

009.0

1 / 2

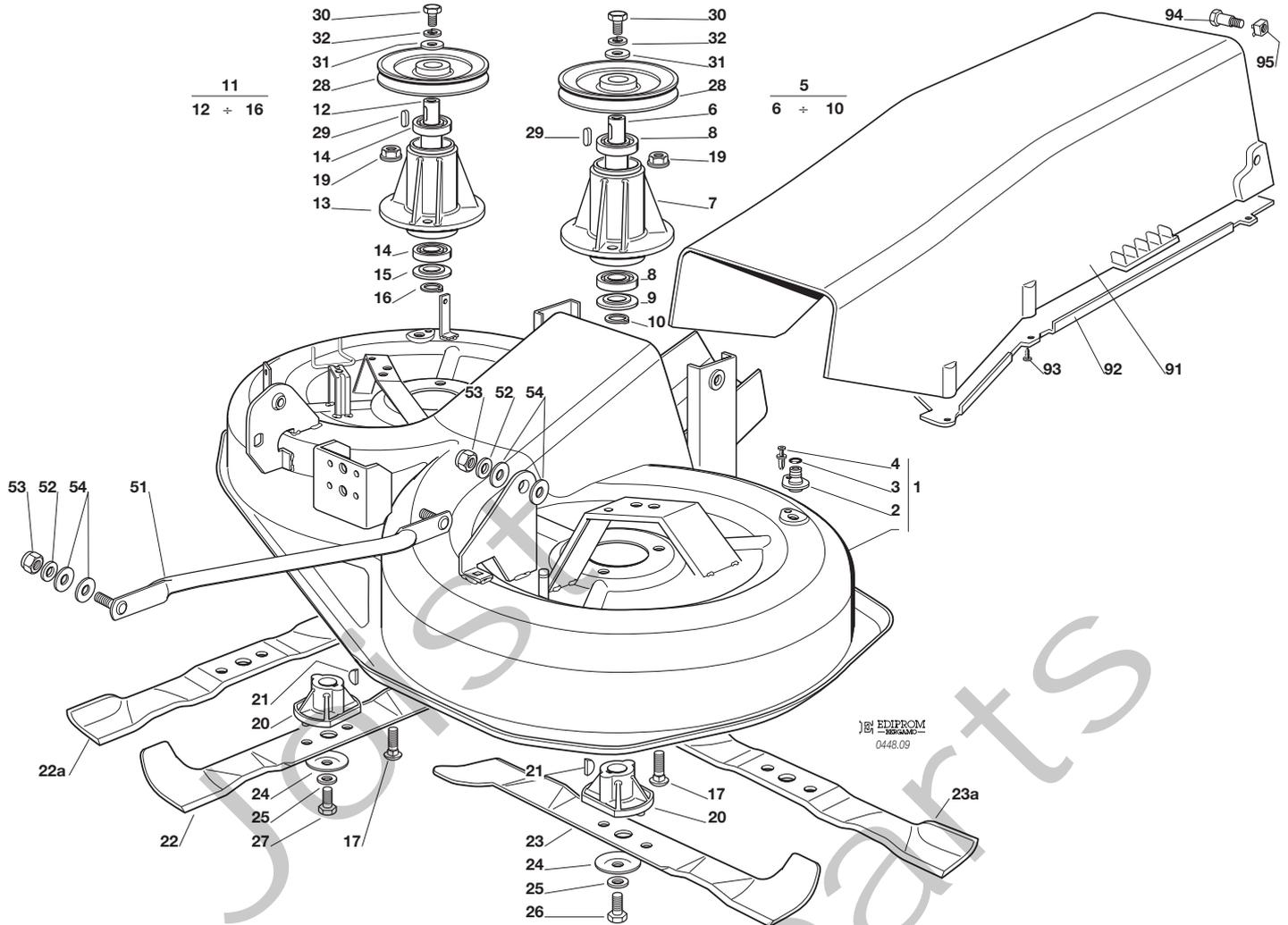

| N. | CODE | Q.TY | DESCRIZIONE | DESCRIPTION | DESCRIPTION | BESCHREIBUNG |
|-----|------------|------|-----------------------------------------|---------------------------------|------------------------------------|------------------------------------|
| 1 | 82564048/0 | 1 | PIATTO | PLATE | PLATEAU | SCHNEID |
| 2 | 25033060/0 | 2 | ATTACCO | WATER HOSE CONNECTION | RACCORD TUYAU D'EAU | WASSERANSCHLUSS |
| 3 | 19035000/0 | 2 | ANELLO OR | O RING | O RING | O RING |
| 4 | 12500030/0 | 2 | RIVETTO | RIVET | RIVET | NIET |
| 5 | 82207202/0 | 1 | ASS. FLANGIA SINISTRA (6÷10) | LEFT FLANGE ASS.Y (6÷10) | ENS. BRIDE GAUCHE (6÷10) | LINKE NABE, KOMPLETT (6÷10) |
| 6 | 25020802/0 | 1 | ALBERO | SHAFT | ARBRE | WELLE |
| 7 | 25207200/0 | 1 | FLANGIA | FLANGE | BRIDE | FLANSCH |
| 8 | 19216032/0 | 2 | CUSCINETTO | BEARING | ROULEMENT | KUEGELLAGER |
| 9 | 25160501/0 | 1 | DISCO PARAPOLVERE | DUST COVER | PROTEGE-POUSSIERE | STAUBSCHUTTSCHIEBE |
| 10 | 12609260/0 | 1 | SEEGER | SEEGER | SEEGER | SEEGER |
| 11 | 82207203/0 | 1 | ASS. FLANGIA DESTRA (12÷16) | RIGHT FLANGE ASS.Y (12÷16) | ENS. BRIDE DROITE (12÷16) | RECHTE NABE, KOMPLETT (12÷16) |
| 12 | 25020803/0 | 1 | ALBERO | SHAFT | ARBRE | WELLE |
| 13 | 25207200/0 | 1 | FLANGIA | FLANGE | BRIDE | FLANSCH |
| 14 | 19216032/0 | 2 | CUSCINETTO | BEARING | ROULEMENT | KÜGELLAGER |
| 15 | 25160501/0 | 1 | DISCO PARAPOLVERE | DUST COVER | PROTEGE-POUSSIERE | STAUBSCHUTTSCHIEBE |
| 16 | 12609260/0 | 1 | SEEGER | SEEGER | SEEGER | SEEGER |
| 17 | 12818700/0 | 6 | VITE | SCREW | VIS | SCHRAUBE |
| 19 | 12154210/0 | 6 | DADO | NUT | ECROU | MUTTER |
| 20 | 25463200/0 | 2 | MOZZO COLTELLO | BLADE HUB | MOYEU LAME | MESSERHALTER |
| 21 | 12139100/0 | 2 | LINGUETTA | KEY | CLAVETTE | KEIL |
| 22 | 82004354/0 | 1 | COLTELLO DESTRO MULCHING, ALETTATO | RIGHT BLADE MULCHING, WINGED | LAME DROITE MULCHING, AILLETTEE | RECHTER MESSER MULCHING, FLÜGEL |
| 22a | 82004352/0 | 1 | COLTELLO DESTRO MULCHING | RIGHT BLADE MULCHING | LAME DROITE MULCHING | RECHTER MESSER MULCHING |
| 23 | 82004353/0 | 1 | COLTELLO SINISTRO MULCHING, ALETTATO | LEFT BLADE MULCHING, WINGED | LAME GAUCHE MULCHING, AILLETTEE | LINKER MESSER MULCHING, FLÜGEL |
| 23a | 81004346/3 | 1 | COLTELLO SINISTRO MULCHING | LEFT BLADE MULCHING | LAME GAUCHE MULCHING | LINKER MESSER MULCHING |
| 24 | 22160400/0 | 2 | DISCO PARAPOLVERE | DUST COVER | PROTEGE-POUSSIERE | STAUBSCHUTTSCHIEBE |





| N. | CODE | Q.TY | DESCRIZIONE | DESCRIPTION | DESCRIPTION | BESCHREIBUNG |
|----|------------|------|----------------------------------------------------------------------|-------------------------------------------------------------------|---------------------------------------------------------------------|--------------------------------------------------------------------|
| 25 | 12523080/0 | 2 | RONDELLA | WASHER | RONDELLE | SCHEIBE |
| 26 | 12735694/0 | 1 | VITE | SCREW | VIS | SCHRAUBE |
| 27 | 12735695/1 | 1 | VITE | SCREW | VIS | SCHRAUBE |
| 28 | 25601573/0 | 2 | PULEGGIA | PULLEY | POULIE | RIEMENSCHIEBE |
| 29 | 12139480/0 | 2 | CHIAVETTA | KEY | CLAVETTE | KEIL |
| 30 | 12793102/0 | 2 | VITE | SCREW | VIS | SCHRAUBE |
| 31 | 25670007/0 | 2 | RONDELLA | WASHER | RONDELLE | SCHEIBE |
| 32 | 12583500/0 | 2 | GROWER | GROWER | GROWER | GROWER |
| — | 82564060/0 | 1 | PIATTO DI TAGLIO ASSEMBLATO (008, 1÷39 + 49÷52 + 009, 1÷32) | CUTTING PLATE, ASSEMBLED (008, 1÷39 + 49÷52 + 009, 1÷32) | PLATEAU DE COUPE, COMPLETE (008, 1÷39 + 49÷52 + 009, 1÷32) | SCHNEIDWERKZEUG, KOMPLETT (008, 1÷39 + 49÷52 + 009, 1÷32) |
| 51 | 82000474/1 | 2 | ASTA BILANCIERE | EQUALIZER ROD | TIGE BALANCIER | KIPPEBEL |
| 52 | 12521360/0 | 4 | RONDELLA | WASHER | RONDELLE | SCHEIBE |
| 53 | 12156602/0 | 4 | DADO | NUT | ECROU | MUTTER |
| 54 | 25670008/1 | 8 | RONDELLA | WASHER | RONDELLE | SCHEIBE |
| 91 | 25108004/0 | 1 | CONVOGLIATORE | CONVEYOR | CONVOYEUR | BLECHSATZ |
| 92 | 25190091/0 | 1 | DEFLETTORE | DEFLECTOR | DEFLECTEUR | ABWEISER |
| 93 | 12735402/0 | 6 | VITE | SCREW | VIS | SCHRAUBE |
| 94 | 25510061/0 | 2 | PERNO | PIN | PIVOT | BOLZEN |
| 95 | 12360430/0 | 2 | DADO | NUT | ECROU | MUTTER |

Joist
Spareparts
Joist

J JP JT JR JTP JB JX

92

92 hydro

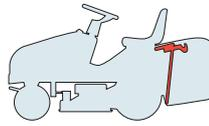

SACCO (1. - PARTE FISSA)
GRASSCATCHER (1. - FIXED PART)
BAC (1. - PARTIE FIXE)
AUFFANGSACK (1. - FESTER TEIL)

2006

010.0

1 / 1

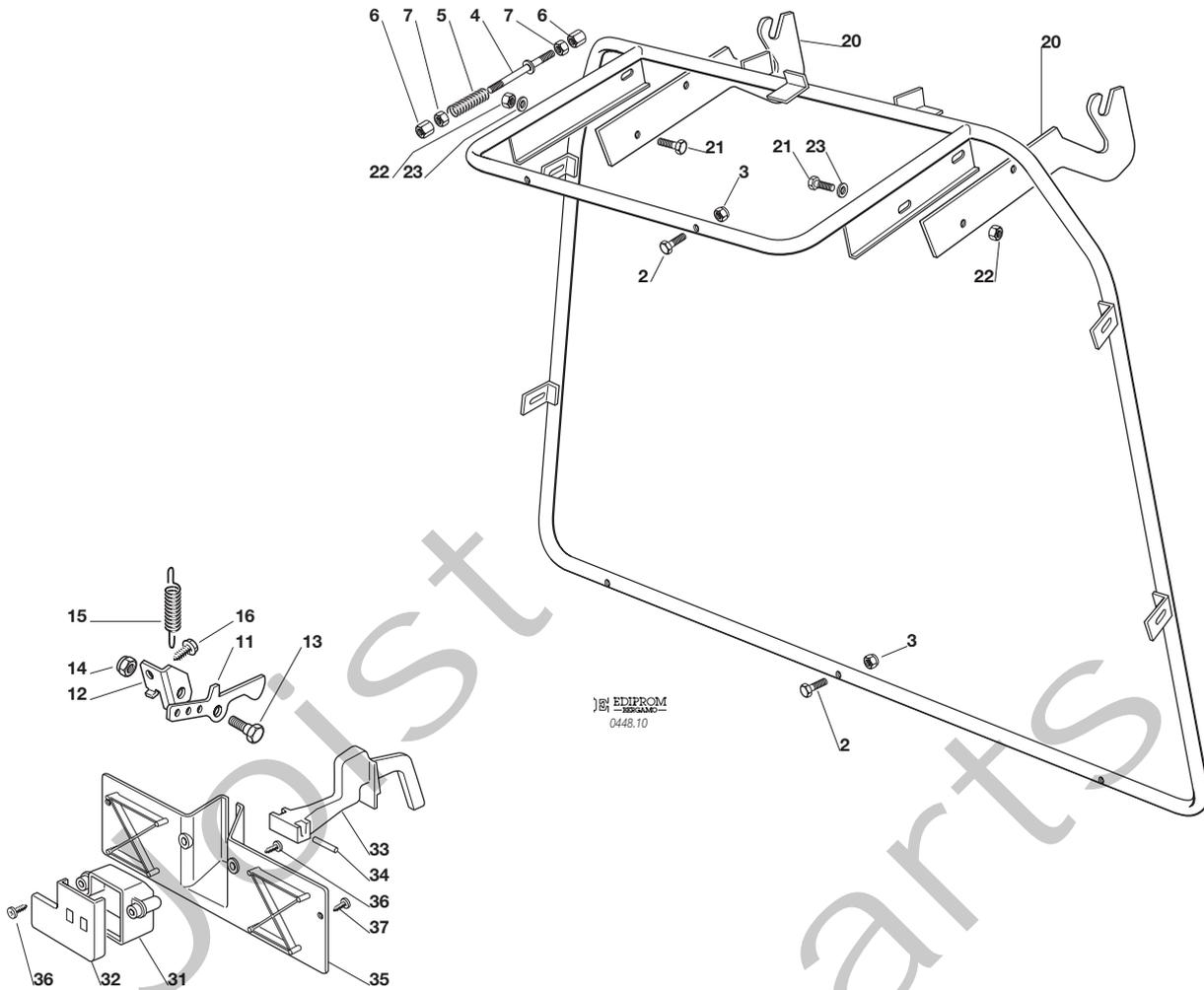

EDIPROM
0448.10

| N. | CODE | Q.TY | DESCRIZIONE | DESCRIPTION | DESCRIPTION | BESCHREIBUNG |
|----|------------|------|----------------------|------------------|----------------------|--------------|
| 1 | 82800017/1 | 1 | TELAIO | FRAME | CHASSIS | RAHMEN |
| 2 | 12791500/0 | 5 | VITE | SCREW | VIS | SCHRAUBE |
| 3 | 12154510/0 | 5 | DADO | NUT | ECROU | MUTTER |
| 4 | 82000465/1 | 1 | ASTA | ROD | TIGE | STANGE |
| 5 | 25430232/0 | 1 | MOLLA | SPRING | RESSORT | FEDER |
| 6 | 25510042/0 | 2 | PERNO | PIN | PIVOT | BOLZEN |
| 7 | 12292100/0 | 2 | DADO | NUT | ECROU | MUTTER |
| 11 | 25774327/0 | 1 | STAFFA | BRACKET | ETRIER | BRIDE |
| 12 | 25755031/0 | 1 | SQUADRETTA | BRACKET | EQUERRE-SUPPORT | WINKEL |
| 13 | 25510080/0 | 1 | PERNO | PIN | PIVOT | BOLZEN |
| 14 | 12292102/0 | 1 | DADO | NUT | ECROU | MUTTER |
| 15 | 25430220/0 | 1 | MOLLA | SPRING | RESSORT | FEDER |
| 16 | 12735122/0 | 1 | VITE | SCREW | VIS | SCHRAUBE |
| 20 | 25785077/0 | 2 | SUPPORTO | SUPPORT | SUPPORT | HALTER |
| 21 | 12793102/0 | 4 | VITE | SCREW | VIS | SCHRAUBE |
| 22 | 12155000/0 | 4 | DADO | NUT | ECROU | MUTTER |
| 23 | 12521350/0 | 4 | RONDELLA | WASHER | RONDELLE | SCHEIBE |
| 31 | 25600041/0 | 1 | PROTEZIONE MICRO | MICRO PROTECTION | PROTECTION MICRO | SCHUTZ |
| 32 | 25600042/0 | 1 | COPERCHIO PROTEZIONE | PROTECTION COVER | COUVERCLE PROTECTION | SCHUTZDEKEL |
| 33 | 25318124/0 | 1 | LEVA | LEVER | LEVIER | HEBEL |
| 34 | 12400030/0 | 1 | PERNO | PIN | PIVOT | BOLZEN |
| 35 | 25774251/0 | 1 | STAFFA | BRACKET | SUPPORT | SHELLE |
| 36 | 12728510/0 | 3 | VITE | SCREW | VIS | SCHRAUBE |
| 37 | 12735110/0 | 2 | VITE | SCREW | VIS | SCHRAUBE |

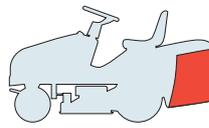
J JP JT JR JTP JB JX**92****92 hydro**

SACCO (2. - PARTE MOBILE)
GRASSCATCHER (2. - MOBILE PART)
BAC (2. - PARTIE MOBILE)
AUFFANGSACK (2. - BEWEGLICHER TEIL)

2006

011.0

1 / 1

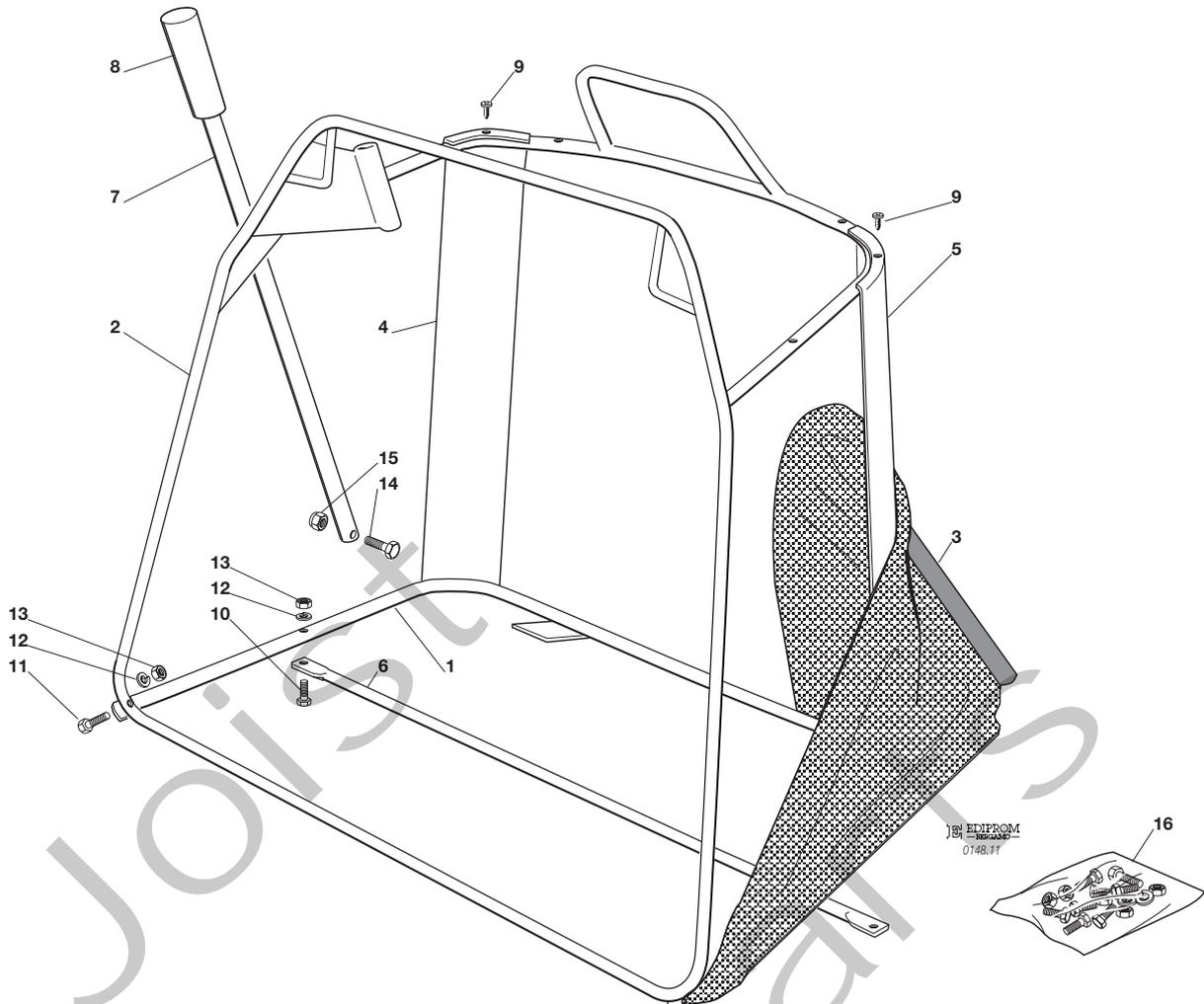

| N. | CODE | Q.TY | DESCRIZIONE | DESCRIPTION | DESCRIPTION | BESCHREIBUNG |
|----|------------|------|--------------------------|-----------------------|--------------------------|----------------------------|
| 1 | 82800015/0 | 1 | TELAIO INFERIORE | LOWER FRAME | CHASSIS INFÉRIEUR | UNTERERRAHMEN |
| 2 | 82800014/1 | 1 | TELAIO SUPERIORE | UPPER FRAME | CHASSIS SUPÉRIEUR | OBERRAHMEN |
| 3 | 82105998/0 | 1 | CONFEZIONE SACCO | GRASSCATCHER | BAC | SACK |
| 4 | 25032005/0 | 1 | ANGOLARE DESTRO | RIGHT ANGULAR SUPPORT | SUPPORT ANGULAIRE DROITE | RECHTER HALTER |
| 5 | 25032004/0 | 1 | ANGOLARE SINISTRO | LEFT ANGULAR SUPPORT | SUPPORT ANGULAIRE GAUCHE | LINKER HALTER |
| 6 | 82650039/0 | 1 | RINFORZO | STIFFENING | RENFORCEMENT | VERSTÄRKUNG |
| 7 | 25869029/1 | 1 | TUBO | ROD | TIGE | STANGE |
| 8 | 25394508/0 | 1 | MANOPOLA | HANDLE | POINGÉE | GRIFF |
| 9 | 12729601/1 | 4 | VITE | SCREW | VIS | SCHRAUBE |
| 10 | 12792099/0 | 2 | VITE | SCREW | VIS | SCHRAUBE |
| 11 | 12792099/0 | 2 | VITE | SCREW | VIS | SCHRAUBE |
| 12 | 12582101/0 | 4 | GROWER | GROWER | GROWER | GROWER |
| 13 | 12292100/0 | 4 | DADO | NUT | ECROU | MUTTER |
| 14 | 12792099/0 | 1 | VITE | SCREW | VIS | SCHRAUBE |
| 15 | 12154510/0 | 1 | DADO | NUT | ECROU | MUTTER |
| 16 | 82180016/1 | 1 | DOTAZIONE VITERIA (9÷15) | SCREWS OUTFIT (9÷15) | ENSEMBLE DES VIS (9÷15) | SCHRAUBENAUSRÜSTUNG (9÷15) |

J JP JT JR JTP JB JX

92

92 hydro

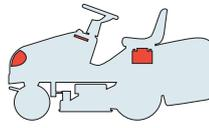

PARTI ELETTRICHE
ELECTRICAL PARTS
PARTIES ELECTRIQUES
ELETRISCHETEILE
B&S - TECUMSEH - KOHLER

2006

012.0

1 / 2

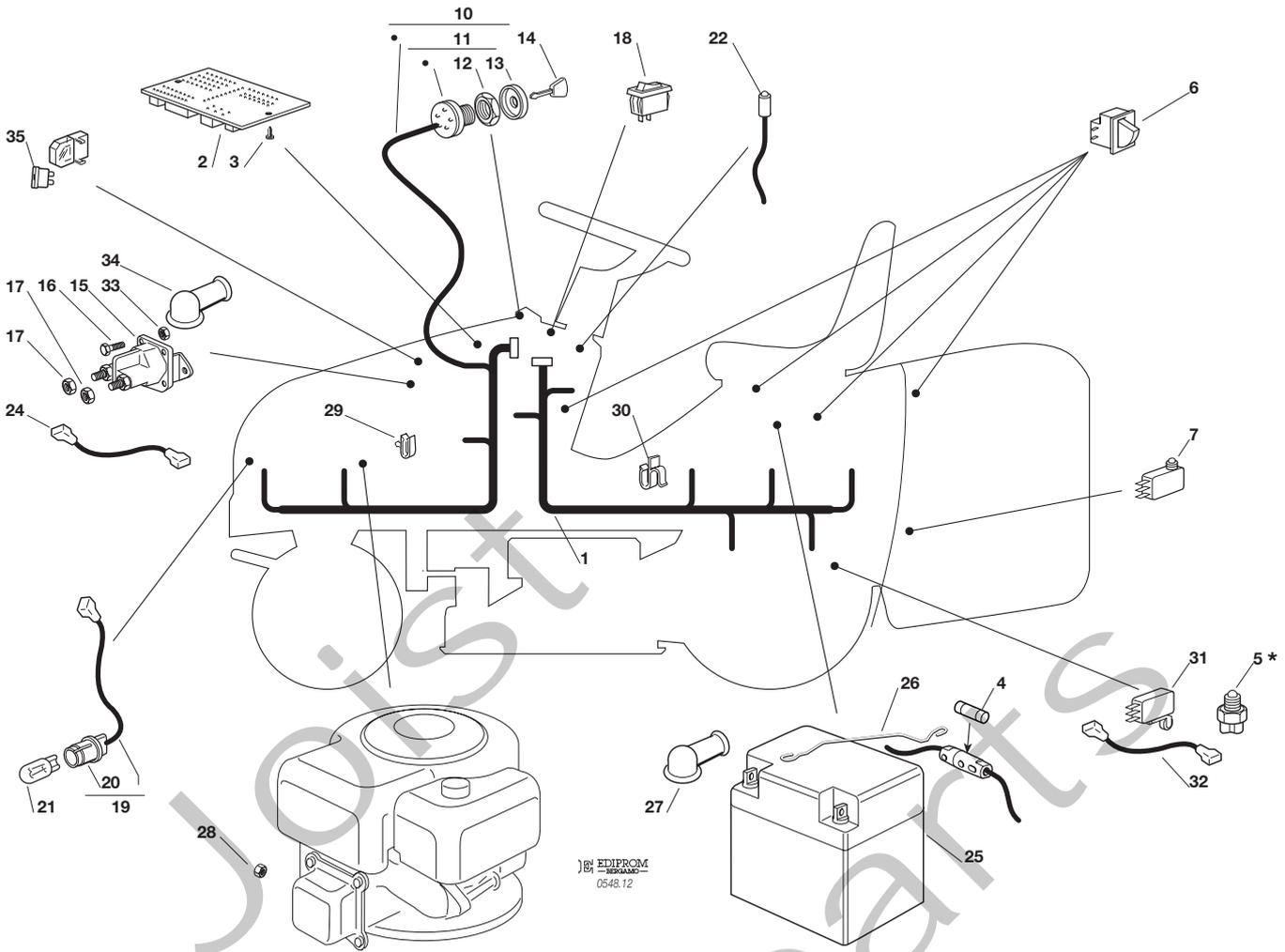

| N. | CODE | Q.TY | DESCRIZIONE | DESCRIPTION | DESCRIPTION | BESCHREIBUNG |
|----|------------|------|---------------------------|------------------------|------------------------------|--------------------------|
| 1 | 82040131/0 | 1 | CABLAGGIO POSTERIORE | CABLES ASS.Y | ENS. CABLAGES | KABELSATZ |
| 2 | 25722415/1 | 1 | SCHEDA ELETTRONICA | ELECTRONIC CARD | CARTE ELECTRONIQUE | ELEKTRONISCHE KARTE |
| 3 | 12727810/0 | 2 | VITE | SCREW | VIS | SCHRAUBE |
| 4 | 33340033/0 | 1 | FUSIBILE 6,3A | FUSE 6,3A | FUSIBLE 6,3A | SICHERUNG 6,3A |
| 5* | - | 1 | INTERRUTT. CAMBIO (mecc.) | GEARBOX SWITCH (mech.) | INT. BOÎTE DE VITESSE (mec.) | ANTRIEB SCHALTER (mech.) |
| 6 | 19410606/0 | 4 | MICRO INTERRUTTORE | MICROSWITCH | MICROINTERRUPTEUR | MIKROSCHALTER |
| 7 | 19410605/1 | 1 | MICRO SACCO PIENO | FULL GRASSCATCHER | MICRO BAC PLEIN | VOLLKORB VORRICHTUNG |
| 10 | 82040128/0 | 1 | CABLAGGIO ANTERIORE | CABLES ASS.Y | ENS. CABLAGES | KABELSATZ |
| 11 | 18450065/1 | 1 | INTERRUTTORE AVVIAM. | STARTING SWITCH | INTERRUPTEUR DEMARR. | SCHALTER |
| 12 | 18400861/0 | 1 | GHIERA | RINGNUT | EMBOUT | NUTMUTTER |
| 13 | 18565351/0 | 1 | PROTEZIONE GHIERA | RINGNUT PROTECTION | PROTECTION EMBOUT | NUTMUTTER SCHUTZ |
| 14 | 18210016/1 | 1 | CHIAVE AVVIAMENTO | STARTING KEY | CLEF A DEMARRAGE | SCHLÜSSEL FÜR START |
| 15 | 18736111/0 | 1 | RELÉ AVVIAMENTO | STARTER RELAY | RELAIS D'ALLUMAGE | ANLASSRELAIS |
| 16 | 12791213/1 | 2 | VITE | SCREW | VIS | SCHRAUBE |
| 17 | 12360352/0 | 2 | DADO | NUT | ECROU | MUTTER |
| 18 | 18450060/1 | 1 | INTERRUTTORE | FARILAMP SWITCH | INTERRUPTEUR PHARES | LICHTEN SCHALTER |
| 19 | 82040070/0 | 1 | CAVO FARI | CABLE | CABLES | KABEL |
| 19 | 82040073/0 | 1 | CAVO FARI (JX) | CABLE (JX) | CABLES (JX) | KABEL (JX) |
| 20 | 33500030/0 | 2 | PORTALAMPADE | LAMP HOLDER | DOUILLE DE LAMPE | SCHEINWERFERLAMPE |
| 21 | 18459100/0 | 2 | LAMPADA | FARILAMP FOR LIGHTS | LAMPE POUR PHARES | LAMPENFASSUN |
| 22 | 25065014/1 | 1 | CAVO LED SEGNALEZIONE | CABLE | CABLES | KABEL |
| 24 | 25065017/0 | 1 | CABLAGGIO SOLEN. AVV. | CABLES ASS.Y | ENS. CABLAGES | KABELSATZ |
| 25 | 18120002/1 | 1 | BATTERIA | BATTERY | BATTERIE | BATTERIE |
| 26 | 25430230/0 | 1 | MOLLA | SPRING | RESSORT | FEDER |
| 27 | 18564861/1 | 1 | CAPPUCCIO | PROTECTION | CAPUCHON | STECKER |
| 28 | 12361005/0 | 1 | DADO | NUT | ECROU | MUTTER |
| 29 | 33320506/0 | 4 | FERMACAVO | FAIRLED | FIXATION CABLE | KABELBEFESTIGUNG |
| 30 | 33320504/0 | 1 | FERMACAVO | FAIRLED | FIXATION CABLE | KABELBEFESTIGUNG |
| 31 | 19410609/0 | 1 | INTERRUTT. FOLLE (hydro) | MICROSWITCH (hydro) | MICROINTERRUPTEUR (hydro) | MIKROSCHALTER (hydro) |
| 32 | 25065025/0 | 1 | CAVO MICRO FOLLE (hydro) | CABLE (hydro) | CABLES (hydro) | KABEL (hydro) |
| 33 | 12292102/0 | 2 | DADO | NUT | ECROU | MUTTER |





| N. | CODE | Q.TY | DESCRIZIONE | DESCRIPTION | DESCRIPTION | BESCHREIBUNG |
|----|------------|------|---------------|-------------|--------------|----------------|
| 34 | 18564864/1 | 1 | CAPPUCCIO | PROTECTION | CAPUCHON | STECKER |
| 35 | 33340036/0 | 1 | FUSIBILE 25 A | FUSE 25 A | FUSIBLE 25 A | SICHERUNG 25 A |

PER LA SOSTITUZIONE DELLE PARTI CONTRASSEGNAE CON «*» RIVOLGERSI AL SERVIZIO ASSISTENZA DEL COSTRUTTORE DELLA TRASMISSIONE.
TO REPLACE THE PARTS MARKED «*» SEEK ASSISTANCE FROM THE TRANSMISSION MANUFACTURER'S AFTER SALES SERVICE.
POUR LE REMPLACEMENT DES PIÈCES MARQUÉES AVEC «*» S'ADRESSER AU SERVICE APRÈS VENTES DU CONSTRUCTEUR DE LA TRANSMISSION.
ZUM AUSTAUSCH DER MIT «*» GEKENNZEICHNETEN TEILE, WENDEN SIE SICH AN DEN KUNDENDIENST DES HERSTELLERS DES ANTRIEBS.

Joist
Spareparts
Joist

J JP JT JR JTP JB JX

92

92 hydro

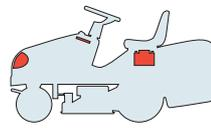

**PARTI ELETTRICHE
ELECTRICAL PARTS
PARTIES ELECTRIQUES
ELETRISCHETEILE
HONDA**

2006

012a.0

1 / 2

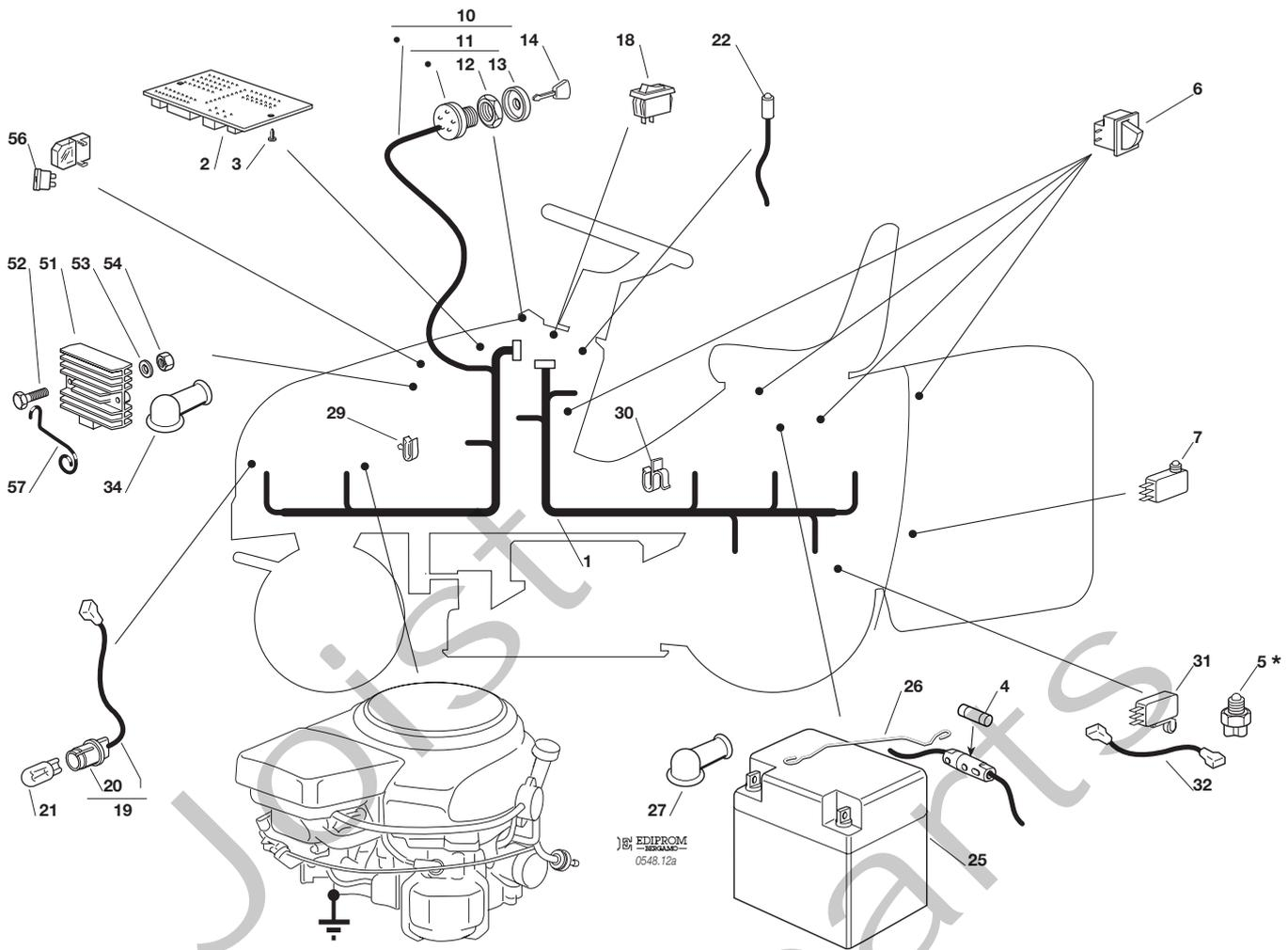

| N. | CODE | Q.TY | DESCRIZIONE | DESCRIPTION | DESCRIPTION | BESCHREIBUNG |
|-----|------------|------|---------------------------|------------------------|------------------------------|--------------------------|
| 1 | 82040127/0 | 1 | CABLAGGIO POSTERIORE | CABLES ASS.Y | ENS. CABLAGES | KABELSATZ |
| 2 | 25722415/1 | 1 | SCHEDA ELETTRONICA | ELECTRONIC CARD | CARTE ELECTRONIQUE | ELEKTRONISCHE KARTE |
| 3 | 12727810/0 | 2 | VITE | SCREW | VIS | SCHRAUBE |
| 4 | 33340033/0 | 1 | FUSIBILE 6,3A | FUSE 6,3A | FUSIBLE 6,3A | SICHERUNG 6,3A |
| 5* | - | 1 | INTERRUTT. CAMBIO (mecc.) | GEARBOX SWITCH (mech.) | INT. BOÎTE DE VITESSE (mec.) | ANTRIEB SCHALTER (mech.) |
| 6 | 19410606/0 | 4 | MICRO INTERRUTTORE | MICROSWITCH | MICROINTERRUPTEUR | MIKROSCHALTER |
| 7 | 19410605/1 | 1 | MICRO SACCO PIENO | FULL GRASSCATCHER | MICRO BAC PLEIN | VOLLKORB VORRICHTUNG |
| 10 | 82040126/0 | 1 | CABLAGGIO ANTERIORE | CABLES ASS.Y | ENS. CABLAGES | KABELSATZ |
| 11 | 18450065/1 | 1 | INTERRUTTORE AVVIAM. | STARTING SWITCH | INTERRUPTEUR DEMARR. | SCHALTER |
| 12 | 18400861/0 | 1 | GHIERA | RINGNUT | EMBOUT | NUTMUTTER |
| 13 | 18565351/0 | 1 | PROTEZIONE GHIERA | RINGNUT PROTECTION | PROTECTION EMBOUT | NUTMUTTER SCHUTZ |
| 14 | 18210016/1 | 1 | CHIAVE AVVIAMENTO | STARTING KEY | CLEF A DEMARRAGE | SCHLÜSSEL FÜR START |
| 18 | 18450060/1 | 1 | INTERRUTTORE | FARILAMP SWITCH | INTERRUPTEUR PHARES | LICHTEN SCHALTER |
| 19 | 82040070/0 | 1 | CAVO FARI | CABLE | CABLES | KABEL |
| 19 | 82040073/0 | 1 | CAVO FARI (JX) | CABLE (JX) | CABLES (JX) | KABEL (JX) |
| 20 | 33500030/0 | 2 | PORTALAMPADE | LAMP HOLDER | DOUILLE DE LAMPE | SCHENWERFERLAMPE |
| 21 | 18459100/0 | 2 | LAMPADA | FARILAMP FOR LIGHTS | LAMPE POUR PHARES | LAMPENFASSUN |
| 22 | 25065014/1 | 1 | CAVO LED SEGNALEZIONE | CABLE | CABLES | KABEL |
| 25 | 18120002/1 | 1 | BATTERIA | BATTERY | BATTERIE | BATTERIE |
| 26 | 25430230/0 | 1 | MOLLA | SPRING | RESSORT | FEDER |
| 27 | 18564861/1 | 1 | CAPPUCCIO | PROTECTION | CAPUCHON | STECKER |
| 29 | 33320506/0 | 4 | FERMACAVO | FAIRLED | FIXATION CABLE | KABELBEFESTIGUNG |
| 30 | 33320504/0 | 1 | FERMACAVO | FAIRLED | FIXATION CABLE | KABELBEFESTIGUNG |
| 31 | 19410609/0 | 1 | INTERRUTT. FOLLE (hydro) | MICROSWITCH (hydro) | MICROINTERRUPTEUR (hydro) | MIKROSCHALTER (hydro) |
| 32 | 25065025/0 | 1 | CAVO MICRO FOLLE (hydro) | CABLE (hydro) | CABLES (hydro) | KABEL (hydro) |
| 34 | 18564864/1 | 1 | CAPPUCCIO | PROTECTION | CAPUCHON | STECKER |
| 51♦ | - | 1 | RELÉ AVVIAMENTO | STARTER RELAY | RELAIS D'ALLUMAGE | ANLASSRELAIS |





| N. | CODE | Q.TY | DESCRIZIONE | DESCRIPTION | DESCRIPTION | BESCHREIBUNG |
|----|------------|------|--------------|-------------|-------------|---------------|
| 52 | 12727793/0 | 2 | VITE | SCREW | VIS | SCHRAUBE |
| 53 | 12551330/0 | 2 | RONDELLA | WASHER | RONDELLE | SCHEIBE |
| 54 | 12154510/0 | 2 | DADO | NUT | ECROU | MUTTER |
| 56 | 33340036/0 | 1 | FUSIBILE 25A | FUSE 25A | FUSIBLE 25A | SICHERUNG 25A |
| 57 | 27430561/0 | 1 | MOLLA | SPRING | RESSORT | FEDER |

PER LA SOSTITUZIONE DELLE PARTI CONTRASSEGNALE CON «*» RIVOLGERSI AL SERVIZIO ASSISTENZA DEL COSTRUTTORE DELLA TRASMISSIONE.
TO REPLACE THE PARTS MARKED «*» SEEK ASSISTANCE FROM THE TRANSMISSION MANUFACTURER'S AFTER SALES SERVICE.
POUR LE REMPLACEMENT DES PIÈCES MARQUÉES AVEC «*» S'ADRESSER AU SERVICE APRÈS VENTES DU CONSTRUCTEUR DE LA TRANSMISSION.
ZUM AUSTAUSCH DER MIT «*» GEKENNZEICHNETEN TEILE, WENDEN SIE SICH AN DEN KUNDENDIENST DES HERSTELLERS DES ANTRIEBS.

PER LA SOSTITUZIONE DELLE PARTI CONTRASSEGNALE CON «◆» RIVOLGERSI AL SERVIZIO ASSISTENZA DEL COSTRUTTORE DEL MOTORE.
TO REPLACE THE PARTS MARKED «◆» SEEK ASSISTANCE FROM THE ENGINE MANUFACTURER'S AFTER SALES SERVICE.
POUR LE REMPLACEMENT DES PIÈCES MARQUÉES AVEC «◆» S'ADRESSER AU SERVICE APRÈS VENTES DU CONSTRUCTEUR DU MOTEUR.
ZUM AUSTAUSCH DER MIT «◆» GEKENNZEICHNETEN TEILE, WENDEN SIE SICH AN DEN KUNDENDIENST DES HERSTELLERS DES MOTOR.

Joist
Spareparts
Joist

J JP JT JR JTP JB JX

92

92 hydro

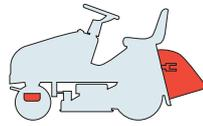

ACCESSORI A RICHIESTA
 OPTIONALS ON REQUEST
 ACCESSOIRES SUR DEMANDE
 ZUBEHOERE NACH ANFRAGE

2006

013.0

1 / 2

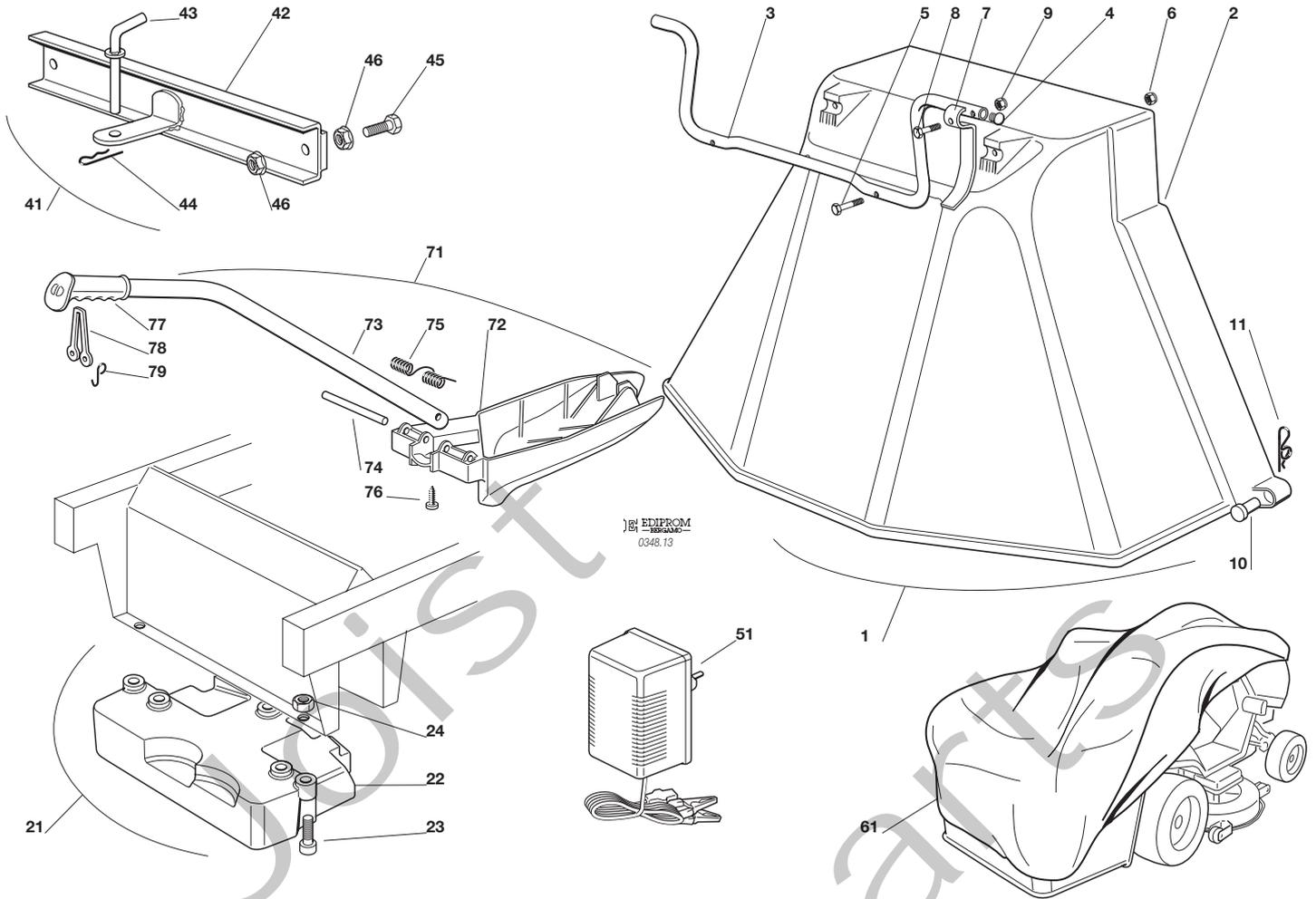

| N. | CODE | Q.TY | DESCRIZIONE | DESCRIPTION | DESCRIPTION | BESCHREIBUNG |
|----|------------|------|------------------------|------------------------|------------------------------|--------------------------|
| 1 | 99900050/0 | 1 | KIT PROTEZIONE USCITA | EJECTION-GUARD KIT | KIT PROTECTION SORTIE | AUSWURESCHUTZVORRICHTUNG |
| 2 | 82400002/0 | 1 | PROTEZIONE USCITA | EJECTION GUARD | PROTECTION SORTIE | AUSWURFSCHUTZ |
| 3 | 25869031/0 | 1 | TUBO DI AGGANCIO | SUPPORT | SOPPORT | HALTER |
| 4 | 18566113/0 | 2 | PUNTALE | CAP | BOUCHON | PFROPFEN |
| 5 | 12674701/0 | 2 | VITE | SCREW | VIS | SCHRAUBE |
| 6 | 12154510/0 | 2 | DADO | NUT | ECROU | MUTTER |
| 7 | 25547053/0 | 1 | PIASTRINA | PLATE | PLAQUETTE | PLÄTTCHEN |
| 8 | 12791500/0 | 1 | VITE | SCREW | VIS | SCHRAUBE |
| 9 | 12154510/0 | 1 | DADO | NUT | ECROU | MUTTER |
| 10 | 25510022/0 | 2 | PERNO | PIN | PIVOT | BOLZEN |
| 11 | 24487998/0 | 2 | COPPIGLIA | COTTER PIN | GOUILLE | SPLIT |
| 21 | 99900030/6 | 1 | ASS. KIT PESO ANT. | FRONT WEIGHT KIT | KIT POIDS ANTERIEUR | VORDERGEWICHTVORRICHTUNG |
| 22 | 25519997/1 | 1 | PESO | WEIGHT | POIDS | GEWICHT |
| 23 | 12760520/0 | 3 | VITE | SCREW | VIS | SCHRAUBE |
| 24 | 12155000/0 | 3 | DADO | NUT | ECROU | MUTTER |
| 41 | 99900080/2 | 1 | ASS. KIT TRAINO | HITCH KIT | KIT DE TRAINAGE | ZUGVORRICHTUNG |
| 42 | 82033103/1 | 1 | BARRA | ROD | BARRE | STANGE |
| 43 | 25510021/1 | 1 | PERNO | PIN | PIVOT | BOLZEN |
| 44 | 24487999/0 | 1 | COPPIGLIA | COTTER PIN | GOUILLE | SPLIT |
| 45 | 12793301/0 | 2 | VITE | SCREW | VIS | SCHRAUBE |
| 46 | 12293201/0 | 4 | DADO | NUT | ECROU | MUTTER |
| 51 | 82180050/0 | 1 | CARICA BATTERIE | BATTERY CHARGER | CHARGEUR DE BATTERIES | BATTERIELADEGERÄT |
| | 82180052/0 | 1 | CARICA BATTERIE (U.K.) | BATTERY CHARGER (U.K.) | CHARGEUR DE BATTERIES (U.K.) | BATTERIELADEGERÄT (U.K.) |
| 61 | 18737950/0 | 1 | TELO DI COPERTURA | CLOTH | BÂCHE | PLANE |





| N. | CODE | Q.TY | DESCRIZIONE | DESCRIPTION | DESCRIPTION | BESCHREIBUNG |
|----|------------|------|------------------|-----------------|------------------|---------------------|
| 71 | 99900038/0 | 1 | KIT MULCHING | MULCHING KIT | KIT MULCHING | MULCHINGVORRICHTUNG |
| 72 | 25140093/0 | 1 | DEFLETTORE | DEFLECTOR | DEFLECTEUR | ABWEISER |
| 73 | 25394007/0 | 1 | MANICO | HANDLE | GUIDON | STIEL |
| 74 | 25510077/0 | 1 | PERNO | PIN | PIVOT | BOLZEN |
| 75 | 25430245/0 | 1 | MOLLA | SPRING | RESSORT | FEDER |
| 76 | 12735410/0 | 1 | VITE | SCREW | VIS | SCHRAUBE |
| 77 | 25280000/1 | 1 | IMPUGNATURA | HANDGRIP | BRANCHE | GRIFF |
| 78 | 25840011/1 | 1 | TIRANTE IN GOMMA | ELASTIC TIE-ROD | TIRANT ELASTIQUE | ELASTISCHE ZUGSTÄBE |
| 79 | 25253004/0 | 2 | GANCIO | HOOK | CROCHET | HAKEN |

Joist
Spareparts
Joist

J JP JT JR JTP JB JX

92

92 hydro

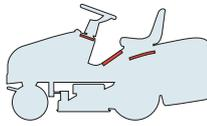

ETICHETTE
LABELS
ETIQUETTES
KLEBZETTEL

2006

014.0

1 / 1

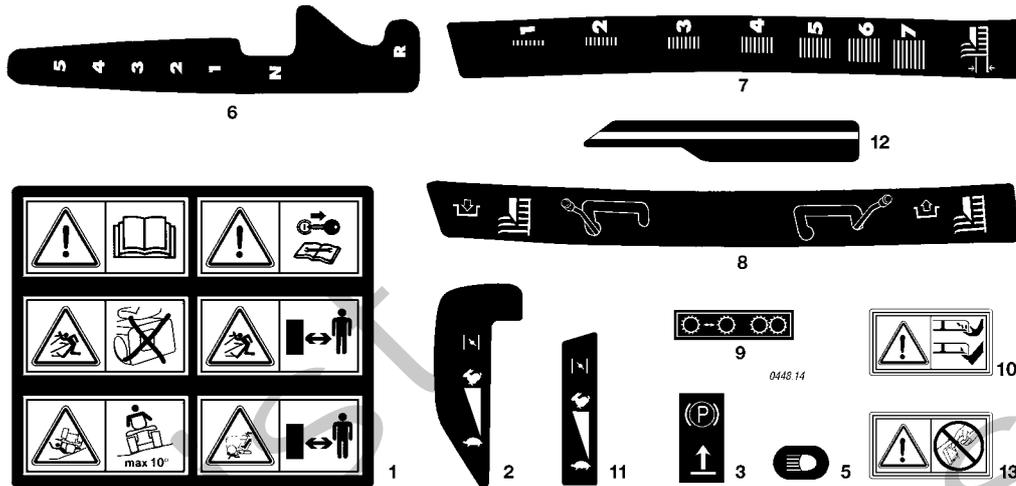

| N. | CODE | Q.TY | DESCRIZIONE | DESCRIPTION | DESCRIPTION | BESCHREIBUNG |
|----|------------|------|-------------------------------|---------------------------|-------------------------------|--------------------------------|
| 1 | 14357190/0 | 1 | ETICHETTA | LABEL | ETIQUETTE | KLEBZETTEL |
| 2 | 14357209/1 | 1 | ETICHETTA (J - JP - JTP - JX) | LABEL (J - JP - JTP - JX) | ETIQUETTE (J - JP - JTP - JX) | KLEBZETTEL (J - JP - JTP - JX) |
| 3 | 14356185/1 | 1 | ETICHETTA | LABEL | ETIQUETTE | KLEBZETTEL |
| 5 | 14357424/1 | 1 | ETICHETTA | LABEL | ETIQUETTE | KLEBZETTEL |
| 6 | 14357210/1 | 1 | ETICHETTA (mecc.) | LABEL (mech.) | ETIQUETTE (mec.) | KLEBZETTEL (mech.) |
| 7 | 14357211/1 | 1 | ETICHETTA | LABEL | ETIQUETTE | KLEBZETTEL |
| 8 | 14357360/1 | 1 | ETICHETTA | LABEL | ETIQUETTE | KLEBZETTEL |
| 9 | 14357423/1 | 1 | ETICHETTA (hydro) | LABEL (hydro) | ETIQUETTE (hydro) | KLEBZETTEL (hydro) |
| 10 | 14356699/0 | 2 | ETICHETTA | LABEL | ETIQUETTE | KLEBZETTEL |
| 11 | 14357357/1 | 1 | ETICHETTA (JT - JR - JB) | LABEL (JT - JR - JB) | ETIQUETTE (JT - JR - JB) | KLEBZETTEL (JT - JR - JB) |
| 12 | 14357361/1 | 1 | ETICHETTA | LABEL | ETIQUETTE | KLEBZETTEL |
| 13 | 14360118/0 | 1 | ETICHETTA | LABEL | ETIQUETTE | KLEBZETTEL |

ELENCO NUMERICO
NUMERICAL LIST
LISTE NUMERIQUE
NUMERISCHE AUFSTELLUNG

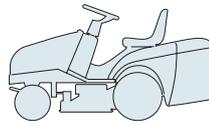

| CODE | TABLE | N. | Q.TY | CODE | TABLE | N. | Q.TY | CODE | TABLE | N. | Q.TY |
|------------|--------|----|------|------------|--------|----|------|------------|--------|----|------|
| 12001000/0 | 003.0 | 5 | 1 | 12155010/0 | 001.0 | 80 | 2 | 12360425/0 | 005b.0 | 17 | 2 |
| 12001000/0 | 003.0 | 76 | 2 | 12155010/0 | 004M.0 | 32 | 1 | 12360425/0 | 005c.0 | 34 | 2 |
| 12001010/0 | 006M.0 | 76 | 2 | 12155010/0 | 004M.0 | 40 | 1 | 12360425/0 | 005d.0 | 34 | 2 |
| 12001010/0 | 006Y.0 | 78 | 2 | 12155010/0 | 008.0 | 84 | 1 | 12360430/0 | 009.0 | 95 | 2 |
| 12139100/0 | 009.0 | 21 | 2 | 12156602/0 | 003.0 | 9 | 2 | 12361005/0 | 012.0 | 28 | 1 |
| 12139430/0 | 006M.0 | 42 | 1 | 12156602/0 | 003.0 | 13 | 1 | 12369500/0 | 006Y.0 | 54 | 1 |
| 12139480/0 | 009.0 | 29 | 2 | 12156602/0 | 003.0 | 54 | 1 | 12379511/0 | 003.0 | 3 | 2 |
| 12141418/0 | 003.0 | 53 | 1 | 12156602/0 | 003.0 | 58 | 2 | 12379511/0 | 004Y.0 | 56 | 1 |
| 12141418/0 | 004M.0 | 50 | 1 | 12156602/0 | 004M.0 | 24 | 1 | 12400030/0 | 010.0 | 34 | 1 |
| 12154210/0 | 001.0 | 37 | 1 | 12156602/0 | 004Y.0 | 13 | 1 | 12436030/0 | 003.0 | 41 | 1 |
| 12154210/0 | 005.0 | 9 | 1 | 12156602/0 | 007.0 | 57 | 1 | 12436050/0 | 002.0 | 4 | 2 |
| 12154210/0 | 005.0 | 24 | 3 | 12156602/0 | 007.0 | 59 | 1 | 12436050/0 | 002a.0 | 4 | 2 |
| 12154210/0 | 005a.0 | 9 | 1 | 12156602/0 | 007.0 | 67 | 1 | 12436050/0 | 002b.0 | 4 | 2 |
| 12154210/0 | 005a.0 | 24 | 3 | 12156602/0 | 007.0 | 69 | 1 | 12436050/0 | 002c.0 | 4 | 2 |
| 12154210/0 | 005b.0 | 9 | 1 | 12156602/0 | 007.0 | 77 | 1 | 12436050/0 | 002d.0 | 4 | 2 |
| 12154210/0 | 005b.0 | 26 | 3 | 12156602/0 | 007.0 | 79 | 1 | 12436050/0 | 004M.0 | 16 | 1 |
| 12154210/0 | 005c.0 | 8 | 4 | 12156602/0 | 009.0 | 53 | 4 | 12436050/0 | 008.0 | 22 | 2 |
| 12154210/0 | 005d.0 | 5 | 1 | 12290800/0 | 002.0 | 36 | 1 | 12436050/0 | 008.0 | 25 | 1 |
| 12154210/0 | 006M.0 | 47 | 4 | 12290800/0 | 002a.0 | 36 | 1 | 12437502/0 | 002.0 | 15 | 2 |
| 12154210/0 | 006Y.0 | 44 | 4 | 12290800/0 | 002b.0 | 36 | 1 | 12437502/0 | 002.0 | 85 | 2 |
| 12154210/0 | 009.0 | 19 | 6 | 12290800/0 | 002c.0 | 36 | 1 | 12437502/0 | 002a.0 | 15 | 2 |
| 12154330/0 | 001.0 | 83 | 2 | 12290800/0 | 002d.0 | 36 | 1 | 12437502/0 | 002a.0 | 85 | 2 |
| 12154330/0 | 002.0 | 49 | 1 | 12290800/0 | 002e.0 | 36 | 1 | 12437502/0 | 002b.0 | 15 | 2 |
| 12154330/0 | 002.0 | 57 | 2 | 12290800/0 | 002f.0 | 36 | 1 | 12437502/0 | 002b.0 | 85 | 2 |
| 12154330/0 | 002a.0 | 49 | 1 | 12292100/0 | 001.0 | 34 | 1 | 12437502/0 | 002c.0 | 15 | 2 |
| 12154330/0 | 002a.0 | 57 | 2 | 12292100/0 | 008.0 | 27 | 1 | 12437502/0 | 002c.0 | 85 | 2 |
| 12154330/0 | 002b.0 | 49 | 1 | 12292100/0 | 010.0 | 7 | 2 | 12437502/0 | 002d.0 | 15 | 2 |
| 12154330/0 | 002b.0 | 57 | 2 | 12292100/0 | 011.0 | 13 | 4 | 12437502/0 | 002d.0 | 85 | 2 |
| 12154330/0 | 002c.0 | 49 | 1 | 12292102/0 | 001.0 | 22 | 2 | 12437502/0 | 002e.0 | 15 | 2 |
| 12154330/0 | 002c.0 | 57 | 2 | 12292102/0 | 001.0 | 47 | 6 | 12437502/0 | 002e.0 | 85 | 2 |
| 12154330/0 | 002d.0 | 49 | 1 | 12292102/0 | 001.0 | 64 | 4 | 12437502/0 | 002f.0 | 15 | 2 |
| 12154330/0 | 002d.0 | 57 | 2 | 12292102/0 | 001.0 | 67 | 4 | 12437502/0 | 002f.0 | 85 | 2 |
| 12154330/0 | 002e.0 | 49 | 1 | 12292102/0 | 001.0 | 93 | 2 | 12500030/0 | 009.0 | 4 | 2 |
| 12154330/0 | 002e.0 | 57 | 2 | 12292102/0 | 001.0 | 95 | 2 | 12521320/0 | 002.0 | 84 | 2 |
| 12154330/0 | 002f.0 | 49 | 1 | 12292102/0 | 004Y.0 | 58 | 2 | 12521320/0 | 002a.0 | 84 | 2 |
| 12154330/0 | 002f.0 | 57 | 2 | 12292102/0 | 006M.0 | 54 | 2 | 12521320/0 | 002b.0 | 84 | 2 |
| 12154510/0 | 001.0 | 7 | 4 | 12292102/0 | 007.0 | 27 | 4 | 12521320/0 | 002c.0 | 84 | 2 |
| 12154510/0 | 004M.0 | 14 | 1 | 12292102/0 | 008.0 | 52 | 1 | 12521320/0 | 002d.0 | 84 | 2 |
| 12154510/0 | 004M.0 | 49 | 1 | 12292102/0 | 010.0 | 14 | 1 | 12521320/0 | 002e.0 | 84 | 2 |
| 12154510/0 | 004Y.0 | 71 | 1 | 12292102/0 | 012.0 | 33 | 2 | 12521320/0 | 002f.0 | 84 | 2 |
| 12154510/0 | 004Y.0 | 74 | 1 | 12293200/0 | 004M.0 | 45 | 1 | 12521330/0 | 003.0 | 61 | 2 |
| 12154510/0 | 004Y.0 | 76 | 1 | 12293200/0 | 004Y.0 | 67 | 2 | 12521330/0 | 004M.0 | 48 | 2 |
| 12154510/0 | 008.0 | 82 | 1 | 12293200/0 | 006M.0 | 18 | 2 | 12521330/0 | 006M.0 | 53 | 2 |
| 12154510/0 | 010.0 | 3 | 5 | 12293200/0 | 006M.0 | 27 | 1 | 12521331/0 | 002.0 | 73 | 4 |
| 12154510/0 | 011.0 | 15 | 1 | 12293200/0 | 006Y.0 | 18 | 2 | 12521331/0 | 002a.0 | 73 | 4 |
| 12154510/0 | 012a.0 | 54 | 2 | 12293200/0 | 007.0 | 33 | 1 | 12521331/0 | 002b.0 | 73 | 4 |
| 12154510/0 | 013.0 | 6 | 2 | 12293201/0 | 001.0 | 72 | 2 | 12521331/0 | 002c.0 | 73 | 4 |
| 12154510/0 | 013.0 | 9 | 1 | 12293201/0 | 001.0 | 78 | 2 | 12521331/0 | 002d.0 | 73 | 4 |
| 12155000/0 | 001.0 | 25 | 2 | 12293201/0 | 002e.0 | 4 | 2 | 12521331/0 | 002e.0 | 73 | 4 |
| 12155000/0 | 003.0 | 33 | 4 | 12293201/0 | 002f.0 | 28 | 2 | 12521331/0 | 002f.0 | 73 | 4 |
| 12155000/0 | 004M.0 | 38 | 1 | 12293201/0 | 006M.0 | 22 | 1 | 12521340/0 | 004M.0 | 51 | 1 |
| 12155000/0 | 004Y.0 | 15 | 1 | 12293201/0 | 006M.0 | 51 | 2 | 12521350/0 | 001.0 | 71 | 2 |
| 12155000/0 | 004Y.0 | 68 | 2 | 12293201/0 | 006Y.0 | 22 | 1 | 12521350/0 | 004M.0 | 15 | 1 |
| 12155000/0 | 006M.0 | 9 | 1 | 12293201/0 | 006Y.0 | 51 | 1 | 12521350/0 | 004Y.0 | 6 | 1 |
| 12155000/0 | 006M.0 | 13 | 1 | 12293201/0 | 007.0 | 17 | 2 | 12521350/0 | 004Y.0 | 14 | 1 |
| 12155000/0 | 006M.0 | 16 | 1 | 12293201/0 | 007.0 | 23 | 1 | 12521350/0 | 006M.0 | 28 | 1 |
| 12155000/0 | 006M.0 | 23 | 1 | 12293201/0 | 008.0 | 13 | 1 | 12521350/0 | 006Y.0 | 47 | 2 |
| 12155000/0 | 006M.0 | 33 | 2 | 12293201/0 | 008.0 | 19 | 2 | 12521350/0 | 007.0 | 37 | 1 |
| 12155000/0 | 006M.0 | 40 | 2 | 12293201/0 | 008.0 | 43 | 1 | 12521350/0 | 010.0 | 23 | 4 |
| 12155000/0 | 006Y.0 | 9 | 1 | 12293201/0 | 008.0 | 44 | 1 | 12521360/0 | 003.0 | 49 | 1 |
| 12155000/0 | 006Y.0 | 13 | 1 | 12293201/0 | 008.0 | 50 | 1 | 12521360/0 | 004M.0 | 9 | 2 |
| 12155000/0 | 006Y.0 | 16 | 1 | 12293201/0 | 008.0 | 73 | 2 | 12521360/0 | 004Y.0 | 10 | 2 |
| 12155000/0 | 006Y.0 | 23 | 1 | 12293201/0 | 013.0 | 46 | 4 | 12521360/0 | 004Y.0 | 69 | 1 |
| 12155000/0 | 006Y.0 | 27 | 2 | 12295200/0 | 003.0 | 44 | 1 | 12521360/0 | 007.0 | 53 | 1 |
| 12155000/0 | 006Y.0 | 34 | 2 | 12295200/0 | 003.0 | 50 | 2 | 12521360/0 | 007.0 | 63 | 1 |
| 12155000/0 | 006Y.0 | 48 | 1 | 12295200/0 | 004M.0 | 10 | 1 | 12521360/0 | 007.0 | 74 | 1 |
| 12155000/0 | 006Y.0 | 56 | 1 | 12295200/0 | 004Y.0 | 12 | 1 | 12521360/0 | 009.0 | 52 | 4 |
| 12155000/0 | 007.0 | 34 | 1 | 12295200/0 | 007.0 | 58 | 1 | 12521370/0 | 003.0 | 40 | 1 |
| 12155000/0 | 007.0 | 36 | 1 | 12295200/0 | 007.0 | 68 | 1 | 12521410/0 | 006M.0 | 74 | 2-4 |
| 12155000/0 | 008.0 | 9 | 1 | 12295200/0 | 007.0 | 78 | 1 | 12521410/0 | 006Y.0 | 75 | 2-4 |
| 12155000/0 | 008.0 | 33 | 1 | 12295300/0 | 003.0 | 18 | 1 | 12521410/0 | 007.0 | 13 | 1 |
| 12155000/0 | 008.0 | 47 | 2 | 12360352/0 | 012.0 | 17 | 2 | 12523020/0 | 002.0 | 56 | 2 |
| 12155000/0 | 008.0 | 51 | 1 | 12360420/0 | 001.0 | 74 | 2 | 12523020/0 | 002a.0 | 56 | 2 |
| 12155000/0 | 008.0 | 79 | 1 | 12360425/0 | 001.0 | 27 | 2 | 12523020/0 | 002b.0 | 56 | 2 |
| 12155000/0 | 010.0 | 22 | 4 | 12360425/0 | 005.0 | 17 | 2 | 12523020/0 | 002c.0 | 56 | 2 |
| 12155000/0 | 013.0 | 24 | 3 | 12360425/0 | 005a.0 | 17 | 2 | 12523020/0 | 002d.0 | 56 | 2 |





| CODE | TABLE | N. | Q.TY | CODE | TABLE | N. | Q.TY | CODE | TABLE | N. | Q.TY |
|------------|--------|----|------|------------|--------|----|------|------------|--------|-----|------|
| 12523020/0 | 002e.0 | 56 | 2 | 12583500/0 | 005d.0 | 13 | 2 | 12728680/0 | 002b.0 | 23 | 1 |
| 12523020/0 | 002f.0 | 56 | 2 | 12583500/0 | 005d.0 | 37 | 2 | 12728680/0 | 002c.0 | 23 | 1 |
| 12523040/0 | 001.0 | 6 | 4 | 12583500/0 | 006M.0 | 26 | 1 | 12728680/0 | 002d.0 | 23 | 1 |
| 12523040/0 | 002.0 | 24 | 5 | 12583500/0 | 009.0 | 32 | 2 | 12728680/0 | 002e.0 | 23 | 1 |
| 12523040/0 | 002a.0 | 24 | 5 | 12583501/0 | 004Y.0 | 63 | 1 | 12728680/0 | 002f.0 | 23 | 1 |
| 12523040/0 | 002b.0 | 24 | 5 | 12587100/0 | 003.0 | 17 | 1 | 12728686/0 | 002c.0 | 27 | 3 |
| 12523040/0 | 002c.0 | 24 | 5 | 12604896/0 | 006Y.0 | 58 | 1 | 12728686/0 | 002d.0 | 27 | 3 |
| 12523040/0 | 002d.0 | 24 | 5 | 12604898/0 | 004M.0 | 22 | 1 | 12728686/0 | 002e.0 | 27 | 3 |
| 12523040/0 | 002e.0 | 24 | 5 | 12604898/0 | 004Y.0 | 36 | 1 | 12729601/1 | 002.0 | 72 | 4 |
| 12523040/0 | 002f.0 | 24 | 5 | 12604899/0 | 004Y.0 | 7 | 1 | 12729601/1 | 002a.0 | 72 | 4 |
| 12523040/0 | 004M.0 | 13 | 1 | 12604899/0 | 006M.0 | 29 | 1 | 12729601/1 | 002b.0 | 72 | 4 |
| 12523040/0 | 004Y.0 | 70 | 1 | 12604899/0 | 007.0 | 9 | 1 | 12729601/1 | 002c.0 | 72 | 4 |
| 12523040/0 | 004Y.0 | 73 | 1 | 12608950/0 | 006M.0 | 43 | 1 | 12729601/1 | 002d.0 | 72 | 4 |
| 12523050/0 | 002.0 | 26 | 4 | 12609200/0 | 008.0 | 5 | 1 | 12729601/1 | 002e.0 | 72 | 4 |
| 12523050/0 | 002a.0 | 26 | 4 | 12609260/0 | 004Y.0 | 60 | 2 | 12729601/1 | 002f.0 | 72 | 4 |
| 12523050/0 | 002b.0 | 26 | 4 | 12609260/0 | 009.0 | 10 | 1 | 12729601/1 | 003.0 | 63 | 2 |
| 12523050/0 | 002c.0 | 25 | 4 | 12609260/0 | 009.0 | 16 | 1 | 12729601/1 | 008.0 | 39 | 2 |
| 12523050/0 | 002d.0 | 25 | 4 | 12610800/0 | 008.0 | 4 | 1 | 12729601/1 | 011.0 | 9 | 4 |
| 12523050/0 | 002e.0 | 25 | 4 | 12620206/0 | 007.0 | 14 | 2 | 12731580/0 | 001.0 | 85 | 2 |
| 12523050/0 | 002f.0 | 25 | 4 | 12620299/0 | 002.0 | 52 | 1 | 12731580/0 | 002.0 | 106 | 4 |
| 12523060/0 | 001.0 | 69 | 2 | 12620299/0 | 002a.0 | 52 | 1 | 12731580/0 | 002a.0 | 106 | 4 |
| 12523060/0 | 002.0 | 46 | 4 | 12620299/0 | 002b.0 | 52 | 1 | 12731580/0 | 002b.0 | 106 | 4 |
| 12523060/0 | 002a.0 | 46 | 4 | 12620299/0 | 002c.0 | 52 | 1 | 12731580/0 | 002c.0 | 106 | 4 |
| 12523060/0 | 002b.0 | 46 | 4 | 12620299/0 | 002d.0 | 52 | 1 | 12731580/0 | 002d.0 | 106 | 4 |
| 12523060/0 | 002c.0 | 46 | 4 | 12620299/0 | 002e.0 | 52 | 1 | 12731580/0 | 002e.0 | 106 | 4 |
| 12523060/0 | 002d.0 | 46 | 4 | 12620299/0 | 002f.0 | 52 | 1 | 12731580/0 | 002f.0 | 106 | 4 |
| 12523060/0 | 002e.0 | 46 | 4 | 12622650/0 | 003.0 | 39 | 1 | 12731601/0 | 004M.0 | 5 | 6 |
| 12523060/0 | 002f.0 | 46 | 4 | 12674701/0 | 013.0 | 5 | 2 | 12731601/0 | 004M.0 | 20 | 4 |
| 12523060/0 | 004M.0 | 39 | 1 | 12689500/0 | 004M.0 | 47 | 1 | 12731601/0 | 004Y.0 | 4 | 4 |
| 12523060/0 | 006M.0 | 12 | 1 | 12691100/0 | 005.0 | 25 | 3 | 12731601/0 | 004Y.0 | 34 | 4 |
| 12523060/0 | 006M.0 | 32 | 1 | 12691100/0 | 005a.0 | 25 | 3 | 12731601/0 | 007.0 | 30 | 4 |
| 12523060/0 | 006M.0 | 39 | 2 | 12691100/0 | 005b.0 | 27 | 3 | 12731601/0 | 008.0 | 41 | 2 |
| 12523060/0 | 006Y.0 | 12 | 1 | 12691100/0 | 006M.0 | 37 | 1 | 12734995/0 | 001.0 | 30 | 2 |
| 12523060/0 | 006Y.0 | 26 | 1 | 12691100/0 | 008.0 | 31 | 1 | 12734995/0 | 002.0 | 65 | 2 |
| 12523060/0 | 006Y.0 | 33 | 2 | 12691115/0 | 005.0 | 7 | 1 | 12734995/0 | 002.0 | 103 | 4 |
| 12523060/0 | 007.0 | 22 | 1 | 12691115/0 | 005a.0 | 7 | 1 | 12734995/0 | 002a.0 | 65 | 2 |
| 12523060/0 | 008.0 | 32 | 1 | 12691115/0 | 005b.0 | 7 | 1 | 12734995/0 | 002a.0 | 103 | 4 |
| 12523060/0 | 008.0 | 46 | 1 | 12691115/0 | 005c.0 | 7 | 4 | 12734995/0 | 002b.0 | 65 | 2 |
| 12523060/0 | 008.0 | 83 | 1 | 12691115/0 | 005d.0 | 6 | 1 | 12734995/0 | 002b.0 | 103 | 4 |
| 12523060/0 | 008.0 | 86 | 1 | 12691115/0 | 006Y.0 | 31 | 1 | 12734995/0 | 002c.0 | 65 | 2 |
| 12523070/0 | 008.0 | 7 | 2 | 12691200/0 | 006M.0 | 38 | 1 | 12734995/0 | 002c.0 | 103 | 4 |
| 12523080/0 | 003.0 | 52 | 1 | 12691200/0 | 006Y.0 | 46 | 1 | 12734995/0 | 002d.0 | 65 | 2 |
| 12523080/0 | 009.0 | 25 | 2 | 12691400/0 | 006Y.0 | 32 | 1 | 12734995/0 | 002d.0 | 103 | 4 |
| 12523100/0 | 003.0 | 16 | 2 | 12691400/0 | 007.0 | 21 | 1 | 12734995/0 | 002e.0 | 65 | 2 |
| 12540020/0 | 004Y.0 | 82 | 2 | 12691700/0 | 008.0 | 6 | 1 | 12734995/0 | 002e.0 | 103 | 4 |
| 12540260/0 | 001.0 | 46 | 1 | 12691800/0 | 006M.0 | 45 | 4 | 12734995/0 | 002f.0 | 65 | 2 |
| 12540260/0 | 005.0 | 8 | 1 | 12691800/0 | 006Y.0 | 42 | 4 | 12734995/0 | 002f.0 | 103 | 4 |
| 12540260/0 | 005.0 | 15 | 2 | 12691900/0 | 006M.0 | 45 | 4 | 12735106/0 | 005b.0 | 25 | 2 |
| 12540260/0 | 005a.0 | 8 | 1 | 12692050/0 | 004M.0 | 37 | 1 | 12735108/0 | 005d.0 | 4 | 3 |
| 12540260/0 | 005a.0 | 15 | 2 | 12692050/0 | 006M.0 | 21 | 1 | 12735110/0 | 002.0 | 14 | 2 |
| 12540260/0 | 005b.0 | 8 | 1 | 12692050/0 | 006Y.0 | 21 | 1 | 12735110/0 | 002.0 | 94 | 1 |
| 12540260/0 | 005b.0 | 15 | 2 | 12692050/0 | 008.0 | 78 | 1 | 12735110/0 | 002a.0 | 14 | 2 |
| 12540260/0 | 005c.0 | 6 | 1 | 12692080/0 | 006M.0 | 7 | 1 | 12735110/0 | 002a.0 | 94 | 1 |
| 12540260/0 | 005c.0 | 33 | 2 | 12692080/0 | 006Y.0 | 7 | 1 | 12735110/0 | 002b.0 | 14 | 2 |
| 12540260/0 | 005d.0 | 7 | 1 | 12692390/0 | 003.0 | 12 | 1 | 12735110/0 | 002b.0 | 94 | 1 |
| 12540260/0 | 005d.0 | 33 | 2 | 12692695/0 | 003.0 | 15 | 1 | 12735110/0 | 002c.0 | 14 | 2 |
| 12543000/0 | 006M.0 | 3 | 1 | 12726388/0 | 002.0 | 35 | 1 | 12735110/0 | 002c.0 | 94 | 1 |
| 12543000/0 | 006Y.0 | 3 | 1 | 12726388/0 | 002a.0 | 35 | 1 | 12735110/0 | 002d.0 | 14 | 2 |
| 12551330/0 | 012a.0 | 53 | 2 | 12726388/0 | 002b.0 | 35 | 1 | 12735110/0 | 002d.0 | 94 | 1 |
| 12581200/0 | 002.0 | 33 | 2 | 12726388/0 | 002c.0 | 35 | 1 | 12735110/0 | 002e.0 | 14 | 2 |
| 12581200/0 | 002a.0 | 33 | 2 | 12726388/0 | 002d.0 | 35 | 1 | 12735110/0 | 002e.0 | 94 | 1 |
| 12581200/0 | 002b.0 | 33 | 2 | 12726388/0 | 002e.0 | 35 | 1 | 12735110/0 | 002f.0 | 14 | 2 |
| 12581200/0 | 002c.0 | 33 | 2 | 12726388/0 | 002f.0 | 35 | 1 | 12735110/0 | 002f.0 | 94 | 1 |
| 12581200/0 | 002d.0 | 33 | 2 | 12727356/0 | 002.0 | 10 | 2 | 12735110/0 | 004Y.0 | 78 | 2 |
| 12581200/0 | 002e.0 | 33 | 2 | 12727356/0 | 002a.0 | 10 | 2 | 12735110/0 | 008.0 | 48 | 2 |
| 12581200/0 | 002f.0 | 33 | 2 | 12727793/0 | 012a.0 | 52 | 2 | 12735110/0 | 008.0 | 54 | 2 |
| 12582101/0 | 011.0 | 12 | 4 | 12727810/0 | 003.0 | 60 | 2 | 12735110/0 | 010.0 | 37 | 2 |
| 12583500/0 | 002.0 | 45 | 4 | 12727810/0 | 012.0 | 3 | 2 | 12735120/0 | 003.0 | 35 | 4 |
| 12583500/0 | 002a.0 | 45 | 4 | 12727810/0 | 012a.0 | 3 | 2 | 12735120/0 | 006Y.0 | 49 | 2 |
| 12583500/0 | 002b.0 | 45 | 4 | 12728450/0 | 002b.0 | 9 | 2 | 12735122/0 | 010.0 | 16 | 1 |
| 12583500/0 | 002c.0 | 45 | 4 | 12728450/0 | 002c.0 | 9 | 2 | 12735150/0 | 006M.0 | 49 | 2 |
| 12583500/0 | 002d.0 | 45 | 4 | 12728450/0 | 002e.0 | 9 | 2 | 12735402/0 | 002.0 | 16 | 3 |
| 12583500/0 | 002e.0 | 45 | 4 | 12728460/0 | 002.0 | 83 | 2 | 12735402/0 | 002.0 | 22 | 4 |
| 12583500/0 | 002f.0 | 45 | 4 | 12728460/0 | 002a.0 | 83 | 2 | 12735402/0 | 002.0 | 64 | 6 |
| 12583500/0 | 004M.0 | 44 | 1 | 12728460/0 | 002b.0 | 83 | 2 | 12735402/0 | 002.0 | 66 | 3 |
| 12583500/0 | 005.0 | 5 | 2 | 12728460/0 | 002c.0 | 83 | 2 | 12735402/0 | 002.0 | 67 | 6 |
| 12583500/0 | 005.0 | 20 | 2 | 12728460/0 | 002d.0 | 83 | 2 | 12735402/0 | 002a.0 | 16 | 3 |
| 12583500/0 | 005a.0 | 5 | 2 | 12728460/0 | 002e.0 | 83 | 2 | 12735402/0 | 002a.0 | 22 | 4 |
| 12583500/0 | 005a.0 | 20 | 2 | 12728460/0 | 002f.0 | 83 | 2 | 12735402/0 | 002a.0 | 64 | 6 |
| 12583500/0 | 005b.0 | 5 | 2 | 12728510/0 | 010.0 | 36 | 3 | 12735402/0 | 002a.0 | 66 | 3 |
| 12583500/0 | 005b.0 | 20 | 2 | 12728680/0 | 002.0 | 23 | 1 | 12735402/0 | 002a.0 | 67 | 6 |
| 12583500/0 | 005c.0 | 37 | 2 | 12728680/0 | 002a.0 | 23 | 1 | 12735402/0 | 002b.0 | 16 | 3 |



| CODE | TABLE | N. | Q.TY | CODE | TABLE | N. | Q.TY | CODE | TABLE | N. | Q.TY |
|------------|--------|----|------|------------|--------|----|------|------------|--------|-----|------|
| 12735402/0 | 002b.0 | 22 | 4 | 12792611/0 | 001.0 | 45 | 4 | 18566110/0 | 002.0 | 102 | 2 |
| 12735402/0 | 002b.0 | 64 | 6 | 12792611/0 | 001.0 | 77 | 2 | 18566110/0 | 002a.0 | 102 | 2 |
| 12735402/0 | 002b.0 | 66 | 3 | 12792611/0 | 003.0 | 32 | 4 | 18566110/0 | 002b.0 | 102 | 2 |
| 12735402/0 | 002b.0 | 67 | 6 | 12792611/0 | 005.0 | 19 | 2 | 18566110/0 | 002c.0 | 102 | 2 |
| 12735402/0 | 002c.0 | 16 | 3 | 12792611/0 | 005a.0 | 19 | 2 | 18566110/0 | 002d.0 | 102 | 2 |
| 12735402/0 | 002c.0 | 22 | 4 | 12792611/0 | 005b.0 | 19 | 2 | 18566110/0 | 002e.0 | 102 | 2 |
| 12735402/0 | 002c.0 | 64 | 6 | 12792611/0 | 005c.0 | 36 | 2 | 18566113/0 | 013.0 | 4 | 2 |
| 12735402/0 | 002c.0 | 66 | 3 | 12792611/0 | 005d.0 | 36 | 2 | 18736111/0 | 012.0 | 15 | 1 |
| 12735402/0 | 002c.0 | 67 | 6 | 12792611/0 | 006M.0 | 50 | 2 | 18737849/0 | 005.0 | 11 | 1 |
| 12735402/0 | 002d.0 | 16 | 3 | 12792611/0 | 006Y.0 | 50 | 1 | 18737849/0 | 005a.0 | 11 | 1 |
| 12735402/0 | 002d.0 | 22 | 4 | 12792611/0 | 007.0 | 16 | 2 | 18737849/0 | 005b.0 | 11 | 1 |
| 12735402/0 | 002d.0 | 64 | 6 | 12792611/0 | 008.0 | 12 | 1 | 18737849/0 | 005c.0 | 10 | 1 |
| 12735402/0 | 002d.0 | 66 | 3 | 12792611/0 | 008.0 | 17 | 2 | 18737849/0 | 005d.0 | 9 | 1 |
| 12735402/0 | 002d.0 | 67 | 6 | 12792611/0 | 008.0 | 72 | 2 | 18737857/0 | 002f.0 | 102 | 2 |
| 12735402/0 | 002e.0 | 16 | 3 | 12792612/0 | 004Y.0 | 62 | 1 | 18737950/0 | 013.0 | 61 | 1 |
| 12735402/0 | 002e.0 | 22 | 4 | 12793101/0 | 002.0 | 44 | 4 | 18738206/0 | 005a.0 | 4 | 1 |
| 12735402/0 | 002e.0 | 64 | 6 | 12793101/0 | 002a.0 | 44 | 4 | 18738211/0 | 005b.0 | 4 | 1 |
| 12735402/0 | 002e.0 | 66 | 3 | 12793101/0 | 002b.0 | 44 | 4 | 18738221/0 | 005c.0 | 12 | 1 |
| 12735402/0 | 002e.0 | 67 | 6 | 12793101/0 | 002c.0 | 44 | 4 | 18738222/0 | 005c.0 | 13 | 1 |
| 12735402/0 | 002f.0 | 16 | 3 | 12793101/0 | 002d.0 | 44 | 4 | 18738224/0 | 005.0 | 4 | 1 |
| 12735402/0 | 002f.0 | 22 | 4 | 12793101/0 | 002e.0 | 44 | 4 | 18738227/0 | 005d.0 | 11 | 1 |
| 12735402/0 | 002f.0 | 64 | 6 | 12793101/0 | 002f.0 | 44 | 4 | 19035000/0 | 009.0 | 3 | 2 |
| 12735402/0 | 002f.0 | 66 | 3 | 12793102/0 | 001.0 | 24 | 2 | 19216032/0 | 009.0 | 8 | 2 |
| 12735402/0 | 002f.0 | 67 | 6 | 12793102/0 | 001.0 | 36 | 1 | 19216032/0 | 009.0 | 14 | 2 |
| 12735402/0 | 009.0 | 93 | 6 | 12793102/0 | 005.0 | 14 | 2 | 19216033/1 | 008.0 | 3 | 1 |
| 12735405/0 | 002f.0 | 7 | 6 | 12793102/0 | 005a.0 | 14 | 2 | 19410605/1 | 012.0 | 7 | 1 |
| 12735410/0 | 002.0 | 21 | 6 | 12793102/0 | 005b.0 | 14 | 2 | 19410605/1 | 012a.0 | 7 | 1 |
| 12735410/0 | 002a.0 | 21 | 6 | 12793102/0 | 005c.0 | 32 | 2 | 19410606/0 | 012.0 | 6 | 4 |
| 12735410/0 | 002b.0 | 21 | 6 | 12793102/0 | 005d.0 | 32 | 2 | 19410606/0 | 012a.0 | 6 | 4 |
| 12735410/0 | 002c.0 | 21 | 6 | 12793102/0 | 006Y.0 | 53 | 1 | 19410609/0 | 012.0 | 31 | 1 |
| 12735410/0 | 002d.0 | 21 | 6 | 12793102/0 | 009.0 | 30 | 2 | 19410609/0 | 012a.0 | 31 | 1 |
| 12735410/0 | 002e.0 | 21 | 6 | 12793102/0 | 010.0 | 21 | 4 | 22034523/0 | 007.0 | 11 | 2 |
| 12735410/0 | 002f.0 | 21 | 6 | 12793301/0 | 013.0 | 45 | 2 | 22041980/0 | 008.0 | 18 | 2 |
| 12735410/0 | 013.0 | 76 | 1 | 12815240/0 | 001.0 | 5 | 4 | 22061337/0 | 008.0 | 80 | 1 |
| 12735530/0 | 005.0 | 6 | 2 | 12818700/0 | 009.0 | 17 | 6 | 22110230/0 | 003.0 | 77 | 2 |
| 12735530/0 | 005a.0 | 6 | 2 | 14356185/1 | 014.0 | 3 | 1 | 22110230/0 | 006M.0 | 77 | 2 |
| 12735530/0 | 005b.0 | 6 | 2 | 14356699/0 | 014.0 | 10 | 2 | 22110230/0 | 006Y.0 | 79 | 2 |
| 12735530/0 | 005d.0 | 12 | 2 | 14357190/0 | 014.0 | 1 | 1 | 22110275/0 | 001.0 | 48 | 1 |
| 12735599/0 | 005c.0 | 5 | 1 | 14357209/1 | 014.0 | 2 | 1 | 22160400/0 | 003.0 | 48 | 1 |
| 12735602/0 | 004Y.0 | 81 | 2 | 14357210/1 | 014.0 | 6 | 1 | 22160400/0 | 009.0 | 24 | 2 |
| 12735694/0 | 009.0 | 26 | 1 | 14357211/1 | 014.0 | 7 | 1 | 22450500/0 | 008.0 | 10 | 1 |
| 12735695/1 | 009.0 | 27 | 1 | 14357357/1 | 014.0 | 11 | 1 | 22524970/2 | 001.0 | 79 | 2 |
| 12737310/0 | 006M.0 | 2 | 1 | 14357360/1 | 014.0 | 8 | 1 | 22672150/0 | 003.0 | 51 | 3 |
| 12737310/0 | 006Y.0 | 2 | 1 | 14357361/1 | 014.0 | 12 | 1 | 22672151/0 | 004M.0 | 33 | 1 |
| 12760520/0 | 013.0 | 23 | 3 | 14357423/1 | 014.0 | 9 | 1 | 22672151/0 | 008.0 | 74 | 1 |
| 12788512/0 | 002.0 | 32 | 2 | 14357424/1 | 014.0 | 5 | 1 | 22672152/0 | 008.0 | 8 | 1 |
| 12788512/0 | 002a.0 | 32 | 2 | 14360118/0 | 014.0 | 13 | 1 | 22672152/0 | 008.0 | 16 | 2 |
| 12788512/0 | 002b.0 | 32 | 2 | 18120002/1 | 012.0 | 25 | 1 | 22672153/0 | 004Y.0 | 61 | 1 |
| 12788512/0 | 002c.0 | 32 | 2 | 18210002/1 | 012a.0 | 25 | 1 | 22746600/0 | 003.0 | 8 | 2 |
| 12788512/0 | 002d.0 | 32 | 2 | 18210016/1 | 012.0 | 14 | 1 | 22746600/0 | 003.0 | 56 | 2 |
| 12788512/0 | 002e.0 | 32 | 2 | 18210016/1 | 012a.0 | 14 | 1 | 22746601/0 | 004M.0 | 43 | 1 |
| 12788512/0 | 002f.0 | 32 | 2 | 18210200/0 | 001.0 | 35 | 1 | 22746601/0 | 006M.0 | 25 | 1 |
| 12789000/0 | 001.0 | 82 | 2 | 18210200/0 | 008.0 | 28 | 1 | 24487997/0 | 007.0 | 38 | 1 |
| 12789000/0 | 002.0 | 48 | 1 | 18375051/1 | 005.0 | 3 | 4 | 24487997/0 | 007.0 | 55 | 1 |
| 12789000/0 | 002a.0 | 48 | 1 | 18375051/1 | 005a.0 | 3 | 2 | 24487997/0 | 007.0 | 65 | 1 |
| 12789000/0 | 002b.0 | 48 | 1 | 18375051/1 | 005b.0 | 3 | 5 | 24487997/0 | 007.0 | 75 | 1 |
| 12789000/0 | 002c.0 | 48 | 1 | 18375051/1 | 005c.0 | 3 | 2 | 24487998/0 | 002e.0 | 5 | 1 |
| 12789000/0 | 002d.0 | 48 | 1 | 18375051/1 | 005d.0 | 3 | 2 | 24487998/0 | 002f.0 | 29 | 1 |
| 12789000/0 | 002e.0 | 48 | 1 | 18399000/0 | 001.0 | 33 | 1 | 24487998/0 | 013.0 | 11 | 2 |
| 12789000/0 | 002f.0 | 48 | 1 | 18399000/0 | 008.0 | 26 | 1 | 24487998/0 | 013.0 | 44 | 1 |
| 12789100/0 | 002.0 | 55 | 2 | 18400861/0 | 012.0 | 12 | 1 | 25020802/0 | 009.0 | 6 | 1 |
| 12789100/0 | 002a.0 | 55 | 2 | 18400861/0 | 012a.0 | 12 | 1 | 25020803/0 | 009.0 | 12 | 1 |
| 12789100/0 | 002b.0 | 55 | 2 | 18400910/2 | 006M.0 | 44 | 1 | 25032004/0 | 011.0 | 5 | 1 |
| 12789100/0 | 002c.0 | 55 | 2 | 18400912/0 | 006M.0 | 44 | 1 | 25032005/0 | 011.0 | 4 | 1 |
| 12789100/0 | 002d.0 | 55 | 2 | 18400960/0 | 006Y.0 | 41 | 1 | 25033002/0 | 007.0 | 6 | 1 |
| 12789100/0 | 002e.0 | 55 | 2 | 18401001/1 | 005.0 | 12 | 1 | 25033012/0 | 004M.0 | 42 | 1 |
| 12789100/0 | 002f.0 | 55 | 2 | 18401001/1 | 005a.0 | 12 | 1 | 25033013/0 | 007.0 | 31 | 1 |
| 12790781/0 | 001.0 | 63 | 4 | 18401001/1 | 005b.0 | 12 | 1 | 25033024/0 | 008.0 | 21 | 1 |
| 12790781/0 | 001.0 | 65 | 4 | 18401001/1 | 005c.0 | 11 | 1 | 25033025/0 | 003.0 | 55 | 1 |
| 12790781/0 | 001.0 | 92 | 2 | 18401001/1 | 005d.0 | 10 | 1 | 25033033/0 | 006Y.0 | 57 | 1 |
| 12790781/0 | 001.0 | 94 | 2 | 18450060/1 | 012.0 | 18 | 1 | 25033036/0 | 004M.0 | 6 | 1 |
| 12791011/0 | 004Y.0 | 57 | 2 | 18450060/1 | 012a.0 | 18 | 1 | 25033041/0 | 004Y.0 | 5 | 1 |
| 12791011/0 | 007.0 | 26 | 4 | 18450065/1 | 012.0 | 11 | 1 | 25033042/0 | 004Y.0 | 64 | 1 |
| 12791213/1 | 004Y.0 | 75 | 1 | 18450065/1 | 012a.0 | 11 | 1 | 25033043/0 | 004M.0 | 21 | 1 |
| 12791213/1 | 008.0 | 81 | 1 | 18459100/0 | 012.0 | 21 | 2 | 25033043/0 | 004Y.0 | 35 | 1 |
| 12791213/1 | 012.0 | 16 | 2 | 18459100/0 | 012a.0 | 21 | 2 | 25033060/0 | 009.0 | 2 | 2 |
| 12791500/0 | 010.0 | 2 | 5 | 18564861/1 | 012.0 | 27 | 1 | 25034002/1 | 003.0 | 2 | 4 |
| 12791500/0 | 013.0 | 8 | 1 | 18564861/1 | 012a.0 | 27 | 1 | 25034002/1 | 004Y.0 | 55 | 2 |
| 12792099/0 | 011.0 | 10 | 2 | 18564864/1 | 012.0 | 34 | 1 | 25038002/1 | 006M.0 | 8 | 2 |
| 12792099/0 | 011.0 | 11 | 2 | 18564864/1 | 012a.0 | 34 | 1 | 25038002/1 | 006Y.0 | 8 | 2 |
| 12792099/0 | 011.0 | 14 | 1 | 18565351/0 | 012.0 | 13 | 1 | 25038004/0 | 003.0 | 36 | 1 |
| 12792611/0 | 001.0 | 42 | 2 | 18565351/0 | 012a.0 | 13 | 1 | 25040617/0 | 003.0 | 42 | 1 |



| CODE | TABLE | N. | Q.TY | CODE | TABLE | N. | Q.TY | CODE | TABLE | N. | Q.TY |
|------------|--------|----|------|------------|--------|----|------|------------|--------|----|------|
| 25060102/0 | 008.0 | 45 | 1 | 25110299/0 | 002e.0 | 71 | 1 | 25410869/0 | 002e.0 | 6 | 1 |
| 25060103/0 | 008.0 | 53 | 1 | 25110299/0 | 002f.0 | 71 | 1 | 25410874/0 | 002f.0 | 5 | 1 |
| 25060111/0 | 008.0 | 61 | 1 | 25110300/0 | 002.0 | 61 | 1 | 25410875/0 | 002f.0 | 6 | 1 |
| 25060112/0 | 008.0 | 62 | 1 | 25110300/0 | 002a.0 | 61 | 1 | 25430205/1 | 001.0 | 70 | 2 |
| 25065014/1 | 012.0 | 22 | 1 | 25110300/0 | 002b.0 | 61 | 1 | 25430208/0 | 007.0 | 8 | 1 |
| 25065014/1 | 012a.0 | 22 | 1 | 25110300/0 | 002c.0 | 61 | 1 | 25430209/0 | 006M.0 | 82 | 8 |
| 25065017/0 | 012.0 | 24 | 1 | 25110300/0 | 002d.0 | 61 | 1 | 25430209/0 | 006Y.0 | 82 | 8 |
| 25065025/0 | 012.0 | 32 | 1 | 25110300/0 | 002e.0 | 61 | 1 | 25430215/0 | 002b.0 | 8 | 2 |
| 25065025/0 | 012a.0 | 32 | 1 | 25110300/0 | 002f.0 | 61 | 1 | 25430215/0 | 002c.0 | 8 | 2 |
| 25076802/0 | 002b.0 | 6 | 1 | 25120151/0 | 002b.0 | 11 | 1 | 25430215/0 | 002e.0 | 8 | 2 |
| 25076808/0 | 002d.0 | 7 | 1 | 25120151/0 | 002c.0 | 11 | 1 | 25430219/0 | 006M.0 | 19 | 1 |
| 25076858/0 | 002f.0 | 1 | 1 | 25120151/0 | 002e.0 | 11 | 1 | 25430219/0 | 006Y.0 | 19 | 1 |
| 25108004/0 | 009.0 | 91 | 1 | 25120164/1 | 002.0 | 11 | 1 | 25430220/0 | 010.0 | 15 | 1 |
| 25108024/0 | 002d.0 | 26 | 1 | 25120164/1 | 002a.0 | 11 | 1 | 25430223/2 | 002.0 | 47 | 1 |
| 25108024/0 | 002e.0 | 26 | 1 | 25120179/0 | 002d.0 | 11 | 1 | 25430223/2 | 002a.0 | 47 | 1 |
| 25108025/0 | 002f.0 | 8 | 1 | 25120179/0 | 002f.0 | 11 | 1 | 25430223/2 | 002b.0 | 47 | 1 |
| 25108028/0 | 002c.0 | 26 | 1 | 25120230/0 | 002.0 | 53 | 1 | 25430223/2 | 002c.0 | 47 | 1 |
| 25108028/0 | 002d.0 | 26 | 1 | 25120230/0 | 002a.0 | 53 | 1 | 25430223/2 | 002d.0 | 47 | 1 |
| 25108028/0 | 002e.0 | 26 | 1 | 25120230/0 | 002b.0 | 53 | 1 | 25430223/2 | 002e.0 | 47 | 1 |
| 25109521/1 | 006M.0 | 55 | 2 | 25120230/0 | 002c.0 | 53 | 1 | 25430223/2 | 002f.0 | 47 | 1 |
| 25109521/1 | 006Y.0 | 35 | 2 | 25120230/0 | 002d.0 | 53 | 1 | 25430226/0 | 004M.0 | 36 | 1 |
| 25110126/1 | 002b.0 | 71 | 1 | 25120230/0 | 002e.0 | 53 | 1 | 25430227/0 | 008.0 | 77 | 1 |
| 25110127/2 | 002b.0 | 61 | 1 | 25122000/2 | 001.0 | 75 | 2 | 25430229/1 | 008.0 | 23 | 2 |
| 25110178/2 | 002.0 | 71 | 1 | 25122200/2 | 003.0 | 73 | 4 | 25430230/0 | 012.0 | 26 | 1 |
| 25110178/2 | 002a.0 | 71 | 1 | 25140093/0 | 013.0 | 72 | 1 | 25430230/0 | 012a.0 | 26 | 1 |
| 25110178/2 | 002b.0 | 71 | 1 | 25160007/0 | 008.0 | 30 | 1 | 25430232/0 | 010.0 | 5 | 1 |
| 25110178/2 | 002c.0 | 71 | 1 | 25160008/0 | 006M.0 | 20 | 1 | 25430234/0 | 004M.0 | 18 | 1 |
| 25110178/2 | 002d.0 | 71 | 1 | 25160008/0 | 006Y.0 | 20 | 1 | 25430234/0 | 004Y.0 | 32 | 1 |
| 25110178/2 | 002e.0 | 71 | 1 | 25160013/0 | 007.0 | 12 | 1 | 25430236/0 | 004M.0 | 8 | 1 |
| 25110178/2 | 002f.0 | 71 | 1 | 25160014/0 | 006M.0 | 36 | 1 | 25430236/0 | 004Y.0 | 9 | 1 |
| 25110179/1 | 002.0 | 61 | 1 | 25160016/0 | 003.0 | 14 | 1 | 25430245/0 | 013.0 | 75 | 1 |
| 25110179/1 | 002a.0 | 61 | 1 | 25160017/0 | 006M.0 | 10 | 1 | 25463200/0 | 009.0 | 20 | 2 |
| 25110179/1 | 002b.0 | 61 | 1 | 25160017/0 | 006Y.0 | 10 | 1 | 25470901/0 | 007.0 | 4 | 1 |
| 25110179/1 | 002c.0 | 61 | 1 | 25160018/0 | 006M.0 | 35 | 1 | 25485001/0 | 002c.0 | 5 | 1 |
| 25110179/1 | 002d.0 | 61 | 1 | 25160024/1 | 006Y.0 | 30 | 1 | 25485002/0 | 002a.0 | 5 | 1 |
| 25110179/1 | 002e.0 | 61 | 1 | 25160026/0 | 004M.0 | 11 | 1 | 25510011/0 | 007.0 | 5 | 1 |
| 25110179/1 | 002f.0 | 61 | 1 | 25160030/0 | 006Y.0 | 29 | 1 | 25510021/0 | 013.0 | 43 | 1 |
| 25110196/1 | 002.0 | 71 | 1 | 25160031/0 | 006Y.0 | 76 | 2 | 25510022/0 | 013.0 | 10 | 2 |
| 25110196/1 | 002a.0 | 71 | 1 | 25160034/0 | 006M.0 | 79 | 2 | 25510023/1 | 002b.0 | 3 | 2 |
| 25110196/1 | 002b.0 | 71 | 1 | 25160035/0 | 005d.0 | 14 | 3 | 25510023/1 | 002d.0 | 3 | 2 |
| 25110196/1 | 002c.0 | 71 | 1 | 25160501/0 | 009.0 | 9 | 1 | 25510024/0 | 007.0 | 52 | 1 |
| 25110196/1 | 002d.0 | 71 | 1 | 25160501/0 | 009.0 | 15 | 1 | 25510024/0 | 007.0 | 62 | 1 |
| 25110196/1 | 002e.0 | 71 | 1 | 25190091/0 | 009.0 | 92 | 1 | 25510032/0 | 007.0 | 20 | 1 |
| 25110198/1 | 002.0 | 71 | 1 | 25207120/0 | 002f.0 | 2 | 1 | 25510035/0 | 004M.0 | 31 | 1 |
| 25110198/1 | 002a.0 | 71 | 1 | 25207121/0 | 002f.0 | 3 | 1 | 25510036/1 | 006M.0 | 31 | 1 |
| 25110198/1 | 002b.0 | 71 | 1 | 25207200/0 | 009.0 | 7 | 1 | 25510036/1 | 006Y.0 | 25 | 1 |
| 25110198/1 | 002d.0 | 71 | 1 | 25207200/0 | 009.0 | 13 | 1 | 25510039/0 | 002a.0 | 3 | 2 |
| 25110198/1 | 002e.0 | 71 | 1 | 25253004/0 | 013.0 | 79 | 2 | 25510039/0 | 002c.0 | 3 | 2 |
| 25110199/1 | 002.0 | 61 | 1 | 25260000/0 | 002b.0 | 10 | 2 | 25510040/1 | 006M.0 | 14 | 1 |
| 25110199/1 | 002a.0 | 61 | 1 | 25260000/0 | 002c.0 | 10 | 2 | 25510040/1 | 006Y.0 | 14 | 1 |
| 25110199/1 | 002b.0 | 61 | 1 | 25260000/0 | 002d.0 | 10 | 2 | 25510040/1 | 007.0 | 32 | 1 |
| 25110199/1 | 002c.0 | 61 | 1 | 25260000/0 | 002e.0 | 10 | 2 | 25510042/0 | 010.0 | 6 | 2 |
| 25110199/1 | 002d.0 | 61 | 1 | 25260000/0 | 002f.0 | 10 | 2 | 25510045/0 | 002.0 | 3 | 2 |
| 25110199/1 | 002e.0 | 61 | 1 | 25270301/0 | 008.0 | 38 | 1 | 25510054/0 | 004Y.0 | 65 | 1 |
| 25110201/1 | 002.0 | 61 | 1 | 25270303/2 | 006M.0 | 52 | 1 | 25510060/0 | 004M.0 | 7 | 1 |
| 25110201/1 | 002a.0 | 61 | 1 | 25270304/1 | 008.0 | 40 | 1 | 25510061/0 | 009.0 | 94 | 2 |
| 25110201/1 | 002b.0 | 61 | 1 | 25270316/0 | 008.0 | 49 | 1 | 25510065/1 | 003.0 | 43 | 1 |
| 25110201/1 | 002d.0 | 61 | 1 | 25270320/0 | 001.0 | 28 | 1 | 25510066/0 | 004Y.0 | 66 | 1 |
| 25110201/1 | 002e.0 | 61 | 1 | 25280000/1 | 013.0 | 77 | 1 | 25510067/1 | 004Y.0 | 8 | 1 |
| 25110263/1 | 002.0 | 20 | 1 | 25318124/0 | 010.0 | 33 | 1 | 25510068/0 | 002e.0 | 3 | 2 |
| 25110263/1 | 002a.0 | 20 | 1 | 25318128/0 | 004M.0 | 46 | 1 | 25510068/0 | 002f.0 | 27 | 2 |
| 25110263/1 | 002b.0 | 20 | 1 | 25318142/0 | 003.0 | 11 | 1 | 25510069/0 | 007.0 | 72 | 1 |
| 25110263/1 | 002c.0 | 20 | 1 | 25318157/0 | 006Y.0 | 52 | 1 | 25510077/0 | 013.0 | 74 | 1 |
| 25110263/1 | 002d.0 | 20 | 1 | 25394007/0 | 013.0 | 73 | 1 | 25510080/0 | 010.0 | 13 | 1 |
| 25110263/1 | 002e.0 | 20 | 1 | 25394501/0 | 002.0 | 34 | 1 | 25519997/1 | 013.0 | 22 | 1 |
| 25110263/1 | 002f.0 | 20 | 1 | 25394501/0 | 002a.0 | 34 | 1 | 25520004/0 | 003.0 | 37 | 1 |
| 25110264/1 | 002.0 | 19 | 1 | 25394501/0 | 002b.0 | 34 | 1 | 25547015/0 | 002b.0 | 2 | 1 |
| 25110264/1 | 002a.0 | 19 | 1 | 25394501/0 | 002c.0 | 34 | 1 | 25547015/0 | 002c.0 | 2 | 1 |
| 25110264/1 | 002b.0 | 19 | 1 | 25394501/0 | 002d.0 | 34 | 1 | 25547015/0 | 002e.0 | 2 | 1 |
| 25110264/1 | 002c.0 | 19 | 1 | 25394501/0 | 002e.0 | 34 | 1 | 25547016/2 | 002b.0 | 2 | 1 |
| 25110264/1 | 002d.0 | 19 | 1 | 25394501/0 | 002f.0 | 34 | 1 | 25547016/2 | 002c.0 | 2 | 1 |
| 25110264/1 | 002e.0 | 19 | 1 | 25394504/1 | 007.0 | 7 | 1 | 25547016/2 | 002e.0 | 2 | 1 |
| 25110264/1 | 002f.0 | 19 | 1 | 25394508/0 | 011.0 | 8 | 1 | 25547024/0 | 002b.0 | 2 | 1 |
| 25110265/0 | 004Y.0 | 52 | 1 | 25394510/0 | 004M.0 | 41 | 1 | 25547024/0 | 002e.0 | 2 | 1 |
| 25110266/0 | 004Y.0 | 53 | 1 | 25394510/0 | 008.0 | 87 | 1 | 25547025/1 | 002.0 | 2 | 1 |
| 25110267/0 | 004Y.0 | 2 | 1 | 25410858/0 | 002b.0 | 5 | 1 | 25547025/1 | 002a.0 | 2 | 1 |
| 25110269/0 | 004M.0 | 2 | 1 | 25410860/0 | 002d.0 | 6 | 1 | 25547025/1 | 002d.0 | 2 | 1 |
| 25110299/0 | 002.0 | 71 | 1 | 25410861/0 | 002d.0 | 5 | 1 | 25547026/0 | 002.0 | 2 | 1 |
| 25110299/0 | 002a.0 | 71 | 1 | 25410865/0 | 002c.0 | 6 | 1 | 25547026/0 | 002a.0 | 2 | 1 |
| 25110299/0 | 002b.0 | 71 | 1 | 25410866/0 | 002a.0 | 6 | 1 | 25547026/0 | 002d.0 | 2 | 1 |
| 25110299/0 | 002c.0 | 71 | 1 | 25410867/0 | 002a.0 | 7 | 1 | 25547028/0 | 002.0 | 2 | 1 |
| 25110299/0 | 002d.0 | 71 | 1 | 25410868/0 | 002e.0 | 7 | 1 | 25547028/0 | 002a.0 | 2 | 1 |



| CODE | TABLE | N. | Q.TY | CODE | TABLE | N. | Q.TY | CODE | TABLE | N. | Q.TY |
|------------|--------|-----|------|------------|--------|----|------|------------|--------|-----|------|
| 25547028/0 | 002d.0 | 2 | 1 | 25601548/1 | 006Y.0 | 1 | 1 | 25785062/2 | 002c.0 | 17 | 1 |
| 25547033/1 | 002.0 | 43 | 1 | 25601554/0 | 006M.0 | 11 | 1 | 25785077/0 | 010.0 | 20 | 2 |
| 25547033/1 | 002a.0 | 43 | 1 | 25601554/0 | 006Y.0 | 11 | 1 | 25785101/0 | 003.0 | 31 | 1 |
| 25547033/1 | 002b.0 | 43 | 1 | 25601555/0 | 006M.0 | 30 | 1 | 25785119/1 | 001.0 | 61 | 1 |
| 25547033/1 | 002c.0 | 43 | 1 | 25601555/0 | 006Y.0 | 24 | 1 | 25785213/0 | 003.0 | 62 | 1 |
| 25547033/1 | 002d.0 | 43 | 1 | 25601555/0 | 008.0 | 29 | 1 | 25795000/1 | 002.0 | 92 | 1 |
| 25547033/1 | 002e.0 | 43 | 1 | 25601557/0 | 007.0 | 19 | 1 | 25795000/1 | 002a.0 | 92 | 1 |
| 25547033/1 | 002f.0 | 43 | 1 | 25601564/0 | 008.0 | 2 | 1 | 25795000/1 | 002b.0 | 92 | 1 |
| 25547037/1 | 007.0 | 25 | 2 | 25601570/0 | 006M.0 | 34 | 2 | 25795000/1 | 002c.0 | 92 | 1 |
| 25547039/0 | 004M.0 | 3 | 1 | 25601570/0 | 006Y.0 | 28 | 2 | 25795000/1 | 002d.0 | 92 | 1 |
| 25547039/0 | 004Y.0 | 3 | 1 | 25601573/0 | 009.0 | 28 | 2 | 25795000/1 | 002e.0 | 92 | 1 |
| 25547041/0 | 004M.0 | 4 | 1 | 25605000/1 | 007.0 | 3 | 1 | 25795000/1 | 002f.0 | 92 | 1 |
| 25547041/0 | 007.0 | 29 | 2 | 25650046/0 | 001.0 | 44 | 1 | 25840002/0 | 006M.0 | 24 | 1 |
| 25547049/0 | 004M.0 | 19 | 2 | 25650055/0 | 001.0 | 62 | 2 | 25840003/2 | 007.0 | 51 | 1 |
| 25547049/0 | 004Y.0 | 33 | 2 | 25650056/0 | 001.0 | 68 | 1 | 25840003/2 | 007.0 | 61 | 1 |
| 25547053/0 | 013.0 | 7 | 1 | 25670005/1 | 003.0 | 75 | 2 | 25840005/0 | 006M.0 | 17 | 1 |
| 25547054/1 | 002.0 | 12 | 1 | 25670005/1 | 006M.0 | 75 | 2 | 25840005/0 | 006Y.0 | 17 | 1 |
| 25547089/0 | 002.0 | 104 | 1 | 25670005/1 | 006Y.0 | 80 | 2 | 25840006/0 | 003.0 | 7 | 1 |
| 25547089/0 | 002a.0 | 104 | 1 | 25670007/0 | 009.0 | 31 | 2 | 25840011/1 | 013.0 | 78 | 1 |
| 25547089/0 | 002b.0 | 104 | 1 | 25670008/1 | 007.0 | 54 | 1 | 25840014/0 | 007.0 | 71 | 1 |
| 25547089/0 | 002c.0 | 104 | 1 | 25670008/1 | 007.0 | 56 | 2 | 25840020/0 | 004M.0 | 42 | 1 |
| 25547089/0 | 002d.0 | 104 | 1 | 25670008/1 | 007.0 | 64 | 1 | 25869006/1 | 005.0 | 13 | 1 |
| 25547091/0 | 002.0 | 105 | 1 | 25670008/1 | 007.0 | 66 | 2 | 25869009/1 | 005.0 | 2 | 1 |
| 25547091/0 | 002a.0 | 105 | 1 | 25670008/1 | 007.0 | 73 | 1 | 25869010/1 | 005b.0 | 2 | 1 |
| 25547091/0 | 002b.0 | 105 | 1 | 25670008/1 | 007.0 | 76 | 2 | 25869016/1 | 005a.0 | 2 | 1 |
| 25547091/0 | 002c.0 | 105 | 1 | 25670008/1 | 009.0 | 54 | 8 | 25869016/1 | 005d.0 | 2 | 1 |
| 25547091/0 | 002d.0 | 105 | 1 | 25670011/0 | 006M.0 | 15 | 2 | 25869027/1 | 005c.0 | 2 | 1 |
| 25547101/0 | 001.0 | 23 | 2 | 25670011/0 | 006Y.0 | 15 | 2 | 25869029/1 | 011.0 | 7 | 1 |
| 25547109/1 | 002e.0 | 104 | 2 | 25670011/0 | 006Y.0 | 55 | 1 | 25869031/0 | 013.0 | 3 | 1 |
| 25547109/1 | 002f.0 | 104 | 2 | 25670011/0 | 007.0 | 35 | 2 | 25943001/0 | 001.0 | 73 | 2 |
| 25547144/0 | 002b.0 | 2 | 1 | 25670011/0 | 008.0 | 20 | 1 | 25950000/0 | 003.0 | 78 | 2 |
| 25570000/2 | 003.0 | 38 | 1 | 25670012/0 | 003.0 | 45 | 2 | 25950000/0 | 006M.0 | 78 | 2 |
| 25580007/0 | 008.0 | 42 | 1 | 25670014/0 | 003.0 | 47 | 1 | 25950000/0 | 006Y.0 | 74 | 2 |
| 25580012/0 | 002.0 | 8 | 1 | 25670017/0 | 006Y.0 | 77 | 2 | 25961201/0 | 002.0 | 51 | 1 |
| 25580012/0 | 002a.0 | 8 | 1 | 25722415/1 | 012.0 | 2 | 1 | 25961201/0 | 002a.0 | 51 | 1 |
| 25580013/0 | 002.0 | 9 | 1 | 25722415/1 | 012a.0 | 2 | 1 | 25961201/0 | 002b.0 | 51 | 1 |
| 25580013/0 | 002a.0 | 9 | 1 | 25722453/1 | 002.0 | 41 | 1 | 25961201/0 | 002c.0 | 51 | 1 |
| 25580019/0 | 001.0 | 21 | 1 | 25722453/1 | 002a.0 | 41 | 1 | 25961201/0 | 002d.0 | 51 | 1 |
| 25580023/0 | 001.0 | 26 | 2 | 25722453/1 | 002b.0 | 41 | 1 | 25961201/0 | 002e.0 | 51 | 1 |
| 25590000/0 | 003.0 | 74 | 2 | 25722453/1 | 002c.0 | 41 | 1 | 25961212/0 | 002f.0 | 51 | 1 |
| 25590001/0 | 006M.0 | 73 | 2 | 25722453/1 | 002d.0 | 41 | 1 | 27063021/1 | 002.0 | 54 | 1 |
| 25590001/0 | 006Y.0 | 73 | 2 | 25722453/1 | 002e.0 | 41 | 1 | 27063021/1 | 002a.0 | 54 | 1 |
| 25590002/0 | 003.0 | 74 | 2 | 25722463/0 | 002f.0 | 41 | 1 | 27063021/1 | 002b.0 | 54 | 1 |
| 25590003/0 | 006M.0 | 73 | 2 | 25730000/0 | 002b.0 | 25 | 1 | 27063021/1 | 002c.0 | 54 | 1 |
| 25590003/0 | 006Y.0 | 73 | 2 | 25730005/1 | 002.0 | 25 | 1 | 27063021/1 | 002d.0 | 54 | 1 |
| 25598050/0 | 005.0 | 10 | 1 | 25730016/0 | 002a.0 | 25 | 1 | 27063021/1 | 002e.0 | 54 | 1 |
| 25598050/0 | 005a.0 | 10 | 1 | 25735116/2 | 002f.0 | 26 | 1 | 27063021/1 | 002f.0 | 54 | 1 |
| 25598050/0 | 005b.0 | 10 | 1 | 25735116/2 | 002a.0 | 91 | 1 | 27395050/1 | 004M.0 | 23 | 1 |
| 25598051/0 | 005c.0 | 9 | 1 | 25735116/2 | 002a.0 | 91 | 1 | 27395050/1 | 004Y.0 | 37 | 1 |
| 25600020/0 | 002.0 | 81 | 1 | 25735116/2 | 002b.0 | 91 | 1 | 27430561/0 | 012a.0 | 57 | 1 |
| 25600020/0 | 002a.0 | 81 | 1 | 25735116/2 | 002c.0 | 91 | 1 | 27546019/0 | 004Y.0 | 80 | 1 |
| 25600020/0 | 002b.0 | 81 | 1 | 25735116/2 | 002d.0 | 91 | 1 | 27598060/0 | 005d.0 | 8 | 1 |
| 25600020/0 | 002c.0 | 81 | 1 | 25735116/2 | 002e.0 | 91 | 1 | 33320504/0 | 012.0 | 30 | 1 |
| 25600020/0 | 002d.0 | 81 | 1 | 25735116/2 | 002f.0 | 91 | 1 | 33320504/0 | 012a.0 | 30 | 1 |
| 25600020/0 | 002e.0 | 81 | 1 | 25735506/1 | 007.0 | 15 | 1 | 33320506/0 | 012.0 | 29 | 4 |
| 25600020/0 | 002f.0 | 81 | 1 | 25735507/0 | 003.0 | 46 | 1 | 33320506/0 | 012a.0 | 29 | 4 |
| 25600021/1 | 002.0 | 82 | 1 | 25743000/0 | 003.0 | 64 | 1 | 33340033/0 | 012.0 | 4 | 1 |
| 25600021/1 | 002a.0 | 82 | 1 | 25755008/0 | 001.0 | 76 | 2 | 33340033/0 | 012a.0 | 4 | 1 |
| 25600021/1 | 002b.0 | 82 | 1 | 25755016/0 | 001.0 | 81 | 1 | 33340036/0 | 012.0 | 35 | 1 |
| 25600021/1 | 002c.0 | 82 | 1 | 25755025/1 | 001.0 | 84 | 1 | 33340036/0 | 012a.0 | 56 | 1 |
| 25600021/1 | 002d.0 | 82 | 1 | 25755031/0 | 010.0 | 12 | 1 | 33500030/0 | 012.0 | 20 | 2 |
| 25600021/1 | 002e.0 | 82 | 1 | 25774247/0 | 006M.0 | 48 | 2 | 33500030/0 | 012a.0 | 20 | 2 |
| 25600021/1 | 002f.0 | 82 | 1 | 25774251/0 | 010.0 | 35 | 1 | 35061980/0 | 006Y.0 | 5 | 1 |
| 25600031/0 | 005b.0 | 24 | 1 | 25774258/0 | 002.0 | 93 | 1 | 35062000/1 | 006M.0 | 5 | 1 |
| 25600033/0 | 002.0 | 62 | 1 | 25774258/0 | 002a.0 | 93 | 1 | 35065700/0 | 008.0 | 34 | 1 |
| 25600033/0 | 002a.0 | 62 | 1 | 25774258/0 | 002b.0 | 93 | 1 | 81004346/3 | 009.0 | 23a | 1 |
| 25600033/0 | 002b.0 | 62 | 1 | 25774258/0 | 002c.0 | 93 | 1 | 82000207/0 | 002.0 | 31 | 1 |
| 25600033/0 | 002c.0 | 62 | 1 | 25774258/0 | 002d.0 | 93 | 1 | 82000207/0 | 002a.0 | 31 | 1 |
| 25600033/0 | 002d.0 | 62 | 1 | 25774258/0 | 002e.0 | 93 | 1 | 82000207/0 | 002b.0 | 31 | 1 |
| 25600033/0 | 002e.0 | 62 | 1 | 25774258/0 | 002f.0 | 93 | 1 | 82000207/0 | 002c.0 | 31 | 1 |
| 25600034/0 | 002.0 | 63 | 1 | 25774275/0 | 004M.0 | 12 | 1 | 82000207/0 | 002d.0 | 31 | 1 |
| 25600034/0 | 002a.0 | 63 | 1 | 25774275/0 | 004Y.0 | 11 | 1 | 82000207/0 | 002e.0 | 31 | 1 |
| 25600034/0 | 002b.0 | 63 | 1 | 25774289/0 | 004Y.0 | 77 | 1 | 82000207/0 | 002f.0 | 31 | 1 |
| 25600034/0 | 002c.0 | 63 | 1 | 25774299/0 | 001.0 | 29 | 2 | 82000210/1 | 002f.0 | 31 | 1 |
| 25600034/0 | 002d.0 | 63 | 1 | 25774327/0 | 010.0 | 11 | 1 | 82000361/0 | 004M.0 | 17 | 1 |
| 25600034/0 | 002e.0 | 63 | 1 | 25785035/3 | 002.0 | 17 | 1 | 82000361/0 | 004Y.0 | 31 | 1 |
| 25600036/0 | 003.0 | 59 | 1 | 25785035/3 | 002a.0 | 17 | 1 | 82000381/2 | 007.0 | 24 | 1 |
| 25600041/0 | 010.0 | 31 | 1 | 25785053/1 | 002d.0 | 17 | 1 | 82000403/0 | 007.0 | 10 | 1 |
| 25600042/0 | 010.0 | 32 | 1 | 25785053/1 | 002e.0 | 17 | 1 | 82000465/1 | 010.0 | 4 | 1 |
| 25600061/0 | 002f.0 | 62 | 1 | 25785053/1 | 002f.0 | 17 | 1 | 82000474/1 | 009.0 | 51 | 2 |
| 25600065/0 | 002f.0 | 63 | 1 | 25785057/0 | 001.0 | 91 | 1 | 82000499/0 | 008.0 | 24 | 1 |
| 25601547/1 | 006M.0 | 1 | 1 | 25785062/2 | 002b.0 | 17 | 1 | 82000505/0 | 001.0 | 32 | 1 |

