

# ILLUSTRATED PARTS LIST

## ES 464



- Use GLOBAL GARDEN PRODUCT Genuine Spare Parts specified in the parts list for repair and/or replacement.
- The contents described in the parts list may change due to improvement.
- The drawings of the spare parts are only indicative and might not represent the part in question exactly.
- The indications "right" - "left" - "front" - "rear" refer to the position of the operator when using the machine.
- When placing orders of parts for repair and/or replacement, make sure that the illustrated parts list is the one applying to the machine's year of manufacture, as shown on the identification plate attached to the machine.

© Copyright 2013 Global Garden Products

All content is subject to copyright by Global Garden Products and may not be reproduced in whole or in part by any means, electronic or otherwise, without prior written approval.

THIS INFORMATION IS NOT INTENDED FOR SALE OR RESALE, AND THIS NOTICE MUST REMAIN ON ALL COPIES.



GLOBAL GARDEN PRODUCTS

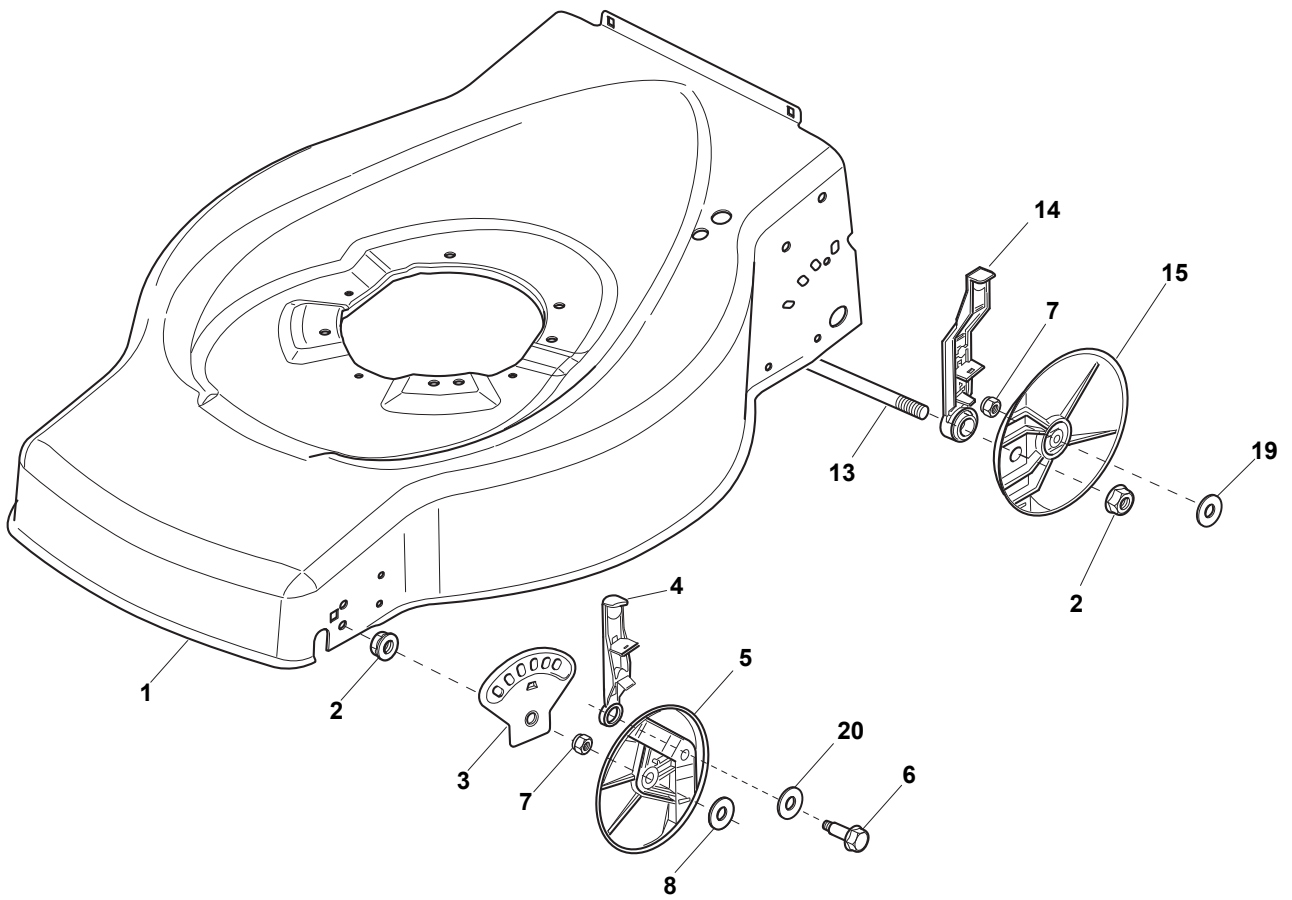

POS	PART. NO	Q.ty	DESCRIPTION	DESCRIZIONE	DESCRIPTION	BESCHREIBUNG	REMARKS
1	381002538/0	1	Deck Red	Chassis Rosso	Châssis Rouge	Gehäuse Rot	
2	122131750/0	4	Nut	Dado	Ecrou	Mutter	
3	322735557/0	1	Sector, Height Adjustment	Settore Regolazione Altezza	Secteur Regl. Hauteur	Sektor, Höheverstellung	
4	381003306/0	2	Lever, Height Adjustment	Leva Regolazione Altezza	Levier Reglage Hauteur	Hebel, Höneverstellung	
5	322600170/0	2	Protection, Wheel	Protezione Ruote	Protection Roue	Schütz, Räder	
6	122524324/0	2	Pin	Perno	Pivot	Bolzen	
7	112155000/0	4	Nut	Dado	Ecrou	Mutter	
8	325670011/0	2	Washer	Rosetta	Rondelle	Scheibe	
13	122033364/0	1	Axle, Rear Wheels	Asse Ruote Posteriore	Axe Roues Arriere	Achse, Hinterrad	
14	381003307/0	2	Lever, Height Adjustment	Leva Regolazione Altezza	Levier Reglage Hauteur	Hebel, Höneverstellung	
15	322600098/0	2	Protection	Cappuccio	Capuchon	Stecker	
19	325670011/0	2	Washer	Rosetta	Rondelle	Scheibe	
20	112530150/0	2	Elastic Washer	Disco Elastico	Disque Elastique	Federscheibe	

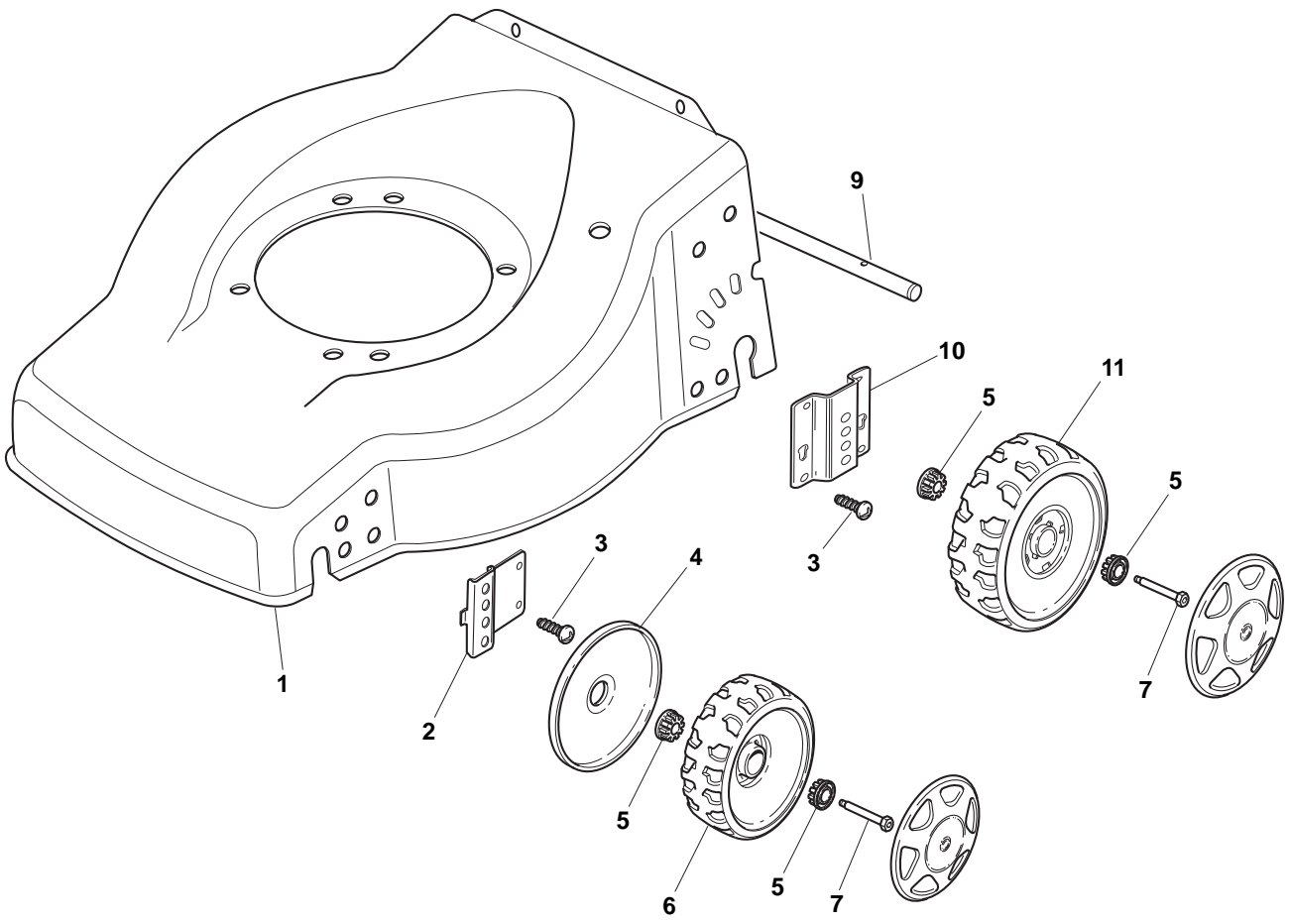

POS	PART. NO	Q.ty	DESCRIPTION	DESCRIZIONE	DESCRIPTION	BESCHREIBUNG	REMARKS
1	381002652/0	1	Deck Red	Chassis Rosso	Châssis Rouge	Gehäuse Rot	
2	322551523/0	2	Plate, Front	Piastra Anteriore	Plaque Antérieure	Platte, Vorder	
3	112728686/0	4	Screw	Vite	Vis	Schraube	
4	322600095/0	2	Protection, Wheel	Protezione Ruote	Protection Roue	Schütz, Räder	
5	322034515/1	8	Bush	Bussola	Douille	Büchse	
6	322686091/1	2	Wheel Ø 165	Ruota Ø 165	Roue Ø 165	Rad Ø 165	
7	122524340/0	4	Pin	Perno	Pivot	Bolzen	
9	122033366/0	1	Axle, Rear Wheels	Asse Ruote Posteriore	Axe Roues Arriere	Achse, Hinterrad	
10	322551525/0	2	Rear Plate	Piastra Posteriore	Plaque Arriere	Platte, Hinter	
11	322686092/0	2	Wheel Ø 190	Ruota Ø 190	Roue Ø190	Rad Ø 190	

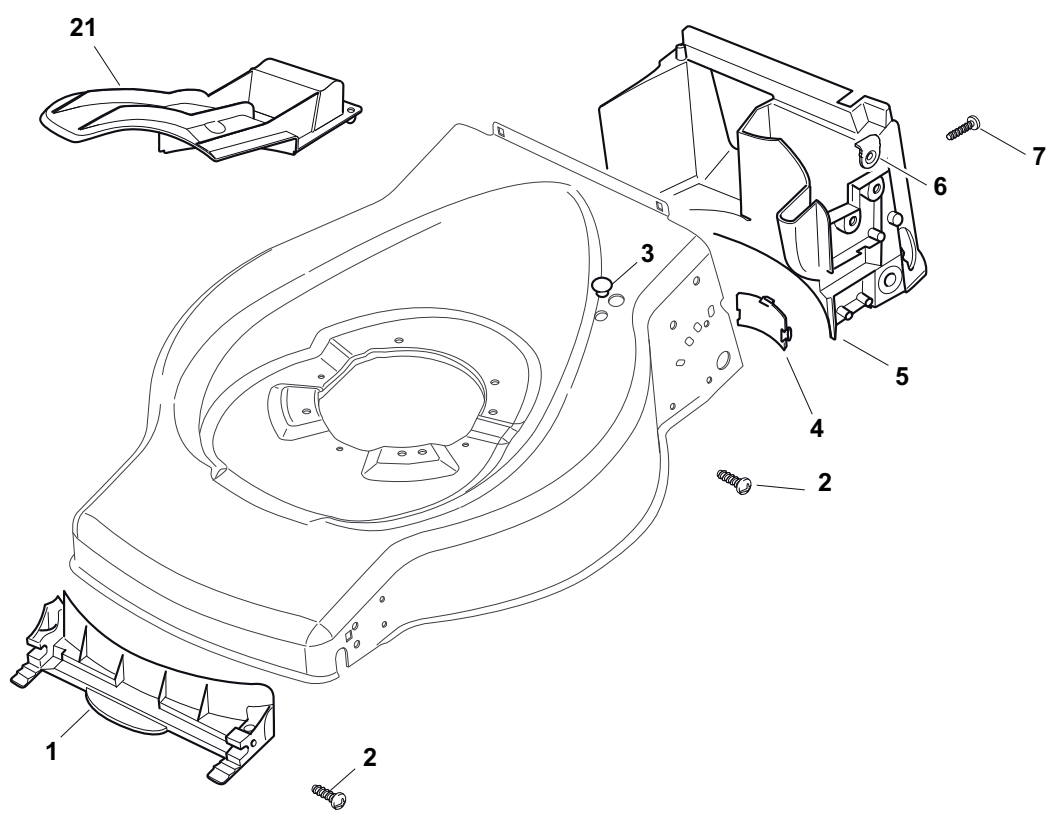

POS	PART. NO	Q.ty	DESCRIPTION	DESCRIZIONE	DESCRIPTION	BESCHREIBUNG	REMARKS
1	322108271/0	1	Front Conveyor Assy	Convogl. Anteriore	Ens. Convoyeur Avant	Hinterleitblechvorder	
2	112728686/0	6	Screw	Vite	Vis	Schraube	
3	322820077/0	1	Cap	Puntale	Bouchon	Gummistopfen	
5	322108272/2	1	Rear Conveyor Assy	Convogl. Posteriore	Ens. Convoyeur Post.	Hinterleitblechsatz	
6	322545189/0	4	Plate	Piastrina	Plaquette	Plättchen	
7	112728686/0	2	Screw	Vite	Vis	Schraube	
21	322140226/0	1	Deflector	Deflettore	Deflecteur	Abweiser	

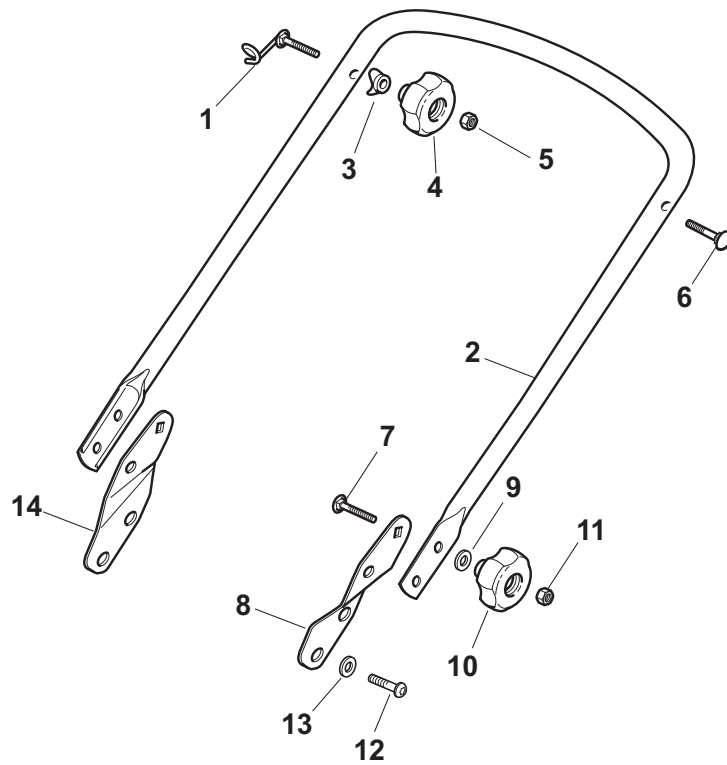



POS	PART. NO	Q.ty	DESCRIPTION	DESCRIZIONE	DESCRIPTION	BESCHREIBUNG	REMARKS
1	181003801/1	1	Guide Spring	Molla Guida	Ressort De Guide	Feder Führer	
2	381006576/0	1	Handle, Lower Part	Parte Inf Maniglia	Poignée, Partie Inferieure	Griff, Unterteil	
3	122680006/1	2	Washer	Rosetta	Rondelle	Scheibe	
4	322399804/1	2	Knob	Manopolina	Poignée	Griff	
5	112293200/0	2	Nut	Dado	Ecrou	Mutter	
6	112819201/0	1	Screw	Vite	Vis	Schraube	
7	112818900/0	2	Screw	Vite	Vis	Schraube	
8	322778425/0	1	Bracket, L	Staffa Sx	Etrier Gauche	Steigbügel, Linke	
9	122671653/0	2	Washer	Rosetta	Rondelle	Scheibe	
10	322399804/1	2	Knob	Manopolina	Poignée	Griff	
11	112293200/0	2	Nut	Dado	Ecrou	Mutter	
12	112760605/0	4	Screw	Vite	Vis	Schraube	
13	112521350/0	4	Washer	Rosetta	Rondelle	Scheibe	
14	322778423/0	1	Bracket, R	Staffa Dx	Etrier Droit	Steigbügel, Rechte	

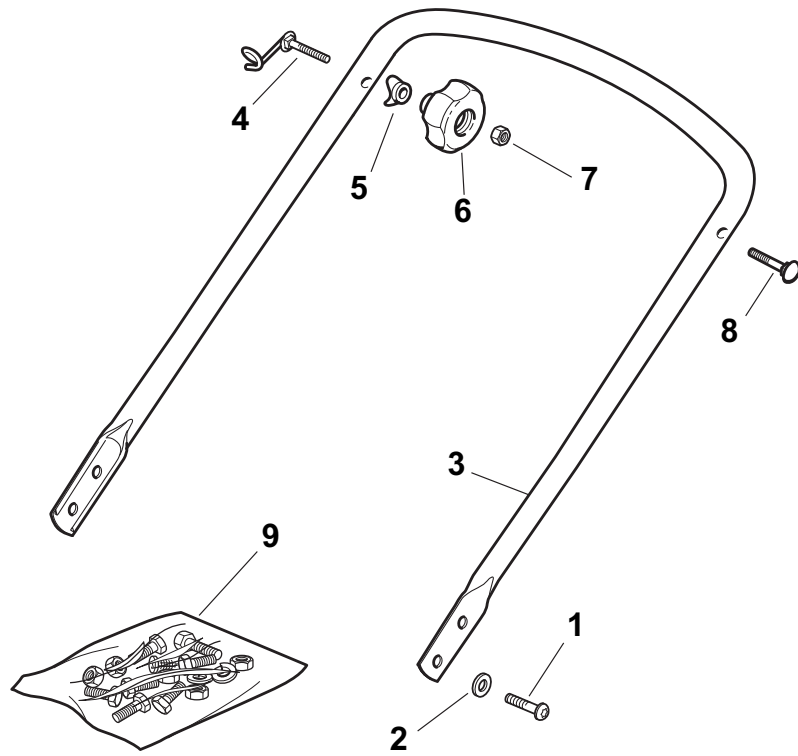

POS	PART. NO	Q.ty	DESCRIPTION	DESCRIZIONE	DESCRIPTION	BESCHREIBUNG	REMARKS
1	112760605/0	4	Screw	Vite	Vis	Schraube	
2	112521350/0	4	Washer	Rosetta	Rondelle	Scheibe	
3	381006570/0	1	Handle, Lower Part	Parte Inf Maniglia	Poignée, Partie Inferieure	Griff, Unterteil	
4	181003801/1	1	Guide Spring	Molla Guida	Ressort De Guide	Feder Führer	
5	122680006/1	2	Washer	Rosetta	Rondelle	Scheibe	
6	322399804/1	2	Knob	Manopolina	Poignée	Griff	
7	112293200/0	2	Nut	Dado	Ecrou	Mutter	
8	112819201/0	1	Screw	Vite	Vis	Schraube	
9	381008648/1	1	Outfit, Screws	Dotazione Viteria	Dotation Visserie	Satz, Schrauben	

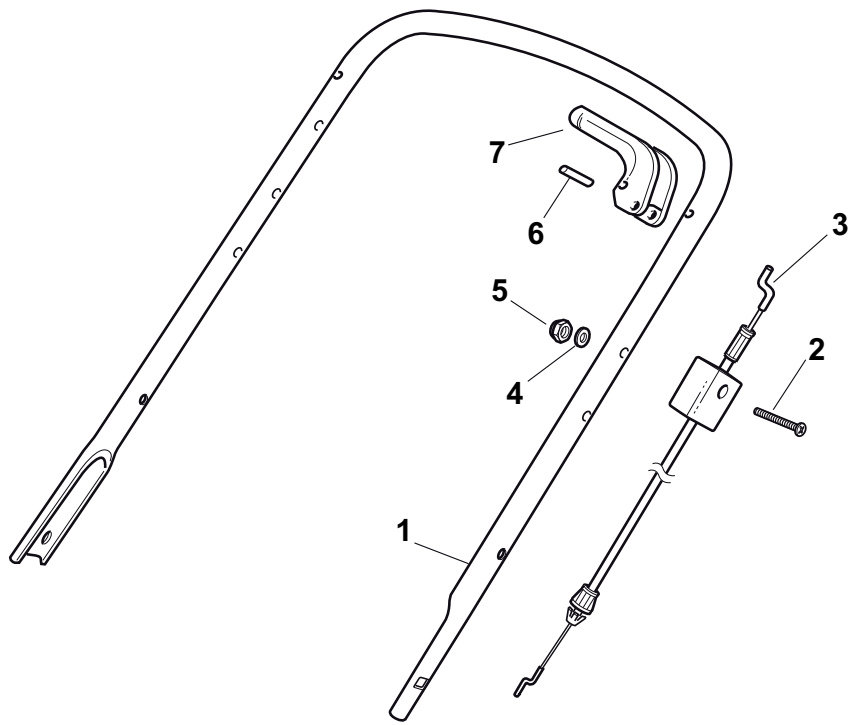

POS	PART. NO	Q.ty	DESCRIPTION	DESCRIZIONE	DESCRIPTION	BESCHREIBUNG	REMARKS
1	381006577/0	1	Handle, Upper Part	Manico, Parte Sup	Mancheron, Partie Superieure	Holm, Oberteil	
2	112674700/0	1	Screw	Vite	Vis	Schraube	
3	181000612/0	1	Cable, Thread Engine Brake	Cavo Freno Motore	Cable Frein Moteur	Kabel, Motorbremse	Sumec
3	181000617/0	1	Cable, Thread Engine Brake	Cavo Freno Motore	Cable Frein Moteur	Kabel, Motorbremse	B&S 625-675
3	181000655/0	1	Cable, Thread Engine Brake	Cavo Freno Motore	Cable Frein Moteur	Kabel, Motorbremse	B&S 450-500 / Honda
4	112521330/0	1	Washer	Rosetta	Rondelle	Scheibe	
5	112292100/0	1	Nut	Dado	Ecrou	Mutter	
6	112645710/0	1	Pin	Perno	Pivot	Bolzen	
7	322321700/1	1	Lever, Eng. Brake	Leva Freno Motore	Levier Frein Moteur	Hebel, Motorbremse	

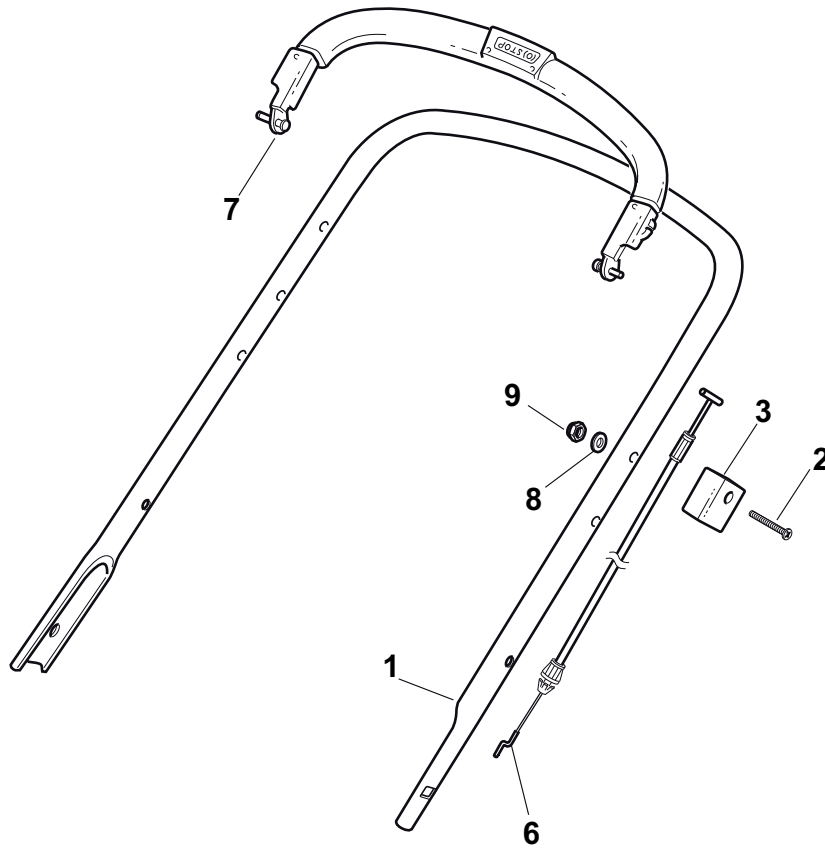

POS	PART. NO	Q.ty	DESCRIPTION	DESCRIZIONE	DESCRIPTION	BESCHREIBUNG	REMARKS
1	381006579/1	1	Handle, Upper Part	Manico, Parte Sup	Mancheron, Partie Superieure	Holm, Oberteil	
2	112689500/0	1	Screw	Vite	Vis	Schraube	
3	322551640/0	1	Plate	Piastrina	Plaquette	Plättchen	
6	181000657/0	1	Cable, Thread Engine Brake	Cavo Freno Motore	Cable Frein Moteur	Kabel, Motorbremse	B&S 450-500
6	181000657/0	1	Cable, Thread Engine Brake	Cavo Freno Motore	Cable Frein Moteur	Kabel, Motorbremse	Honda
6	181030002/0	1	Cable, Thread Engine Brake	Cavo Freno Motore	Cable Frein Moteur	Kabel, Motorbremse	GGP
6	181000720/1	1	Cable, Thread Engine Brake	Cavo Freno Motore	Cable Frein Moteur	Kabel, Motorbremse	B&S 625-675
6	381000743/0	1	Cable, Thread Engine Brake	Cavo Freno Motore	Cable Frein Moteur	Kabel, Motorbremse	Sumec
7	381003298/1	1	Lever, Engine Brake	Leva Freno Motore	Levier Frein Moteur	Hebel, Motorbremse	
8	112521330/0	1	Washer	Rosetta	Rondelle	Scheibe	
9	112292100/0	1	Nut	Dado	Ecrou	Mutter	

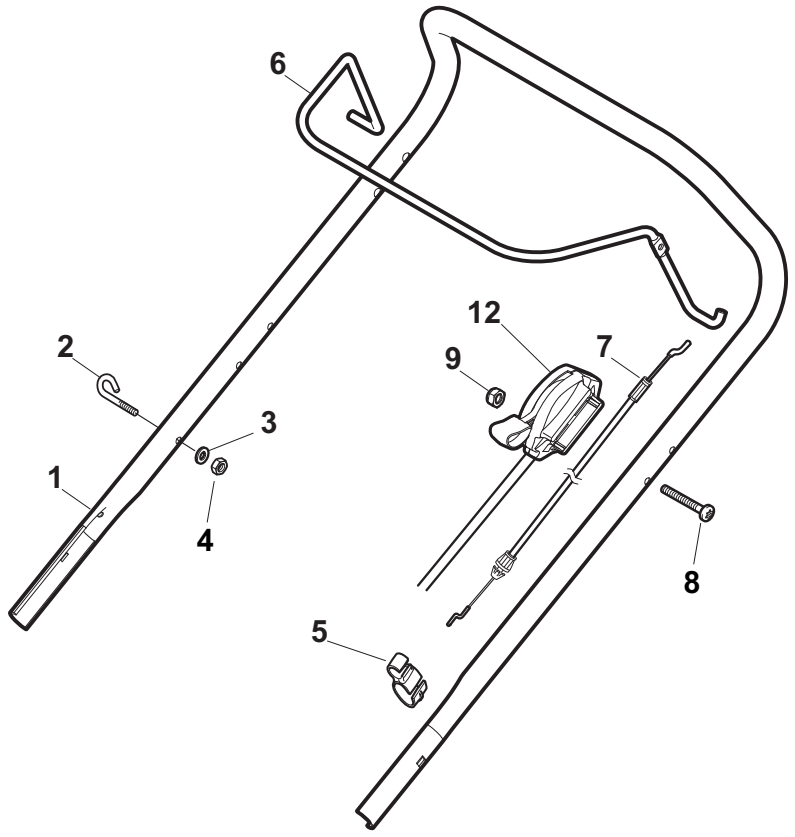



POS	PART. NO	Q.ty	DESCRIPTION	DESCRIZIONE	DESCRIPTION	BESCHREIBUNG	REMARKS
1	381006739/0	1	Handle, Upper Part	Manico, Parte Sup	Mancheron, Partie Superieure	Holm, Oberteil	
1	381006745/0	1	Handle, Upper Part with sponge handgrip	Manico, Parte Sup. con impugantura in spugna	Mancheron, Partie Superieure avec éponge poignée	Holm, Oberteil Handgriff Schwamm	
2	122430313/0	1	Guide Spring	Molla Guida	Ressort De Guide	Feder Führer	
3	112521330/0	1	Washer	Rosetta	Rondelle	Scheibe	
4	112154510/0	1	Nut	Dado	Ecrou	Mutter	
5	118390020/0	1	Fairlead	Fermacavo	Fixation Cable	Kabelbefestigung	
6	181003363/1	1	Lever, Engine Brake Black	Leva Freno Motore Nero	Levier Frein Moteur Noir	Hebel, Motorbremse Schwarz	
6	381003365/0	1	Lever, Engine Brake Yellow	Leva Freno Motore, Giallo	Levier Frein Moteur Jaune	Hebel, Motorbremse, Gelb	
6	381003376/0	1	Lever, Engine Brake Red	Leva Freno Motore, Rosso	Levier Frein Moteur Rouge	Hebel, Motorbremse, Rot	
7	181030053/0	1	Cable, Thread Engine Brake	Cavo Freno Motore	Cable Frein Moteur	Kabel, Motorbremse	Honda - B&S
7	181030054/0	1	Cable, Thread Engine Brake	Cavo Freno Motore	Cable Frein Moteur	Kabel, Motorbremse	Sumec
7	181030087/0	1	Cable, Thread Engine Brake	Cavo Freno Motore	Cable Frein Moteur	Kabel, Motorbremse	GGP 100cc
8	112727788/0	1	Screw	Vite	Vis	Schraube	
9	112154510/0	1	Nut	Dado	Ecrou	Mutter	
12	181005502/1	1	Throttle Cable	Cavo Acceleratore	Cable, Accelérateur	Gashebel Kabel	B&S
12	181005501/1	1	Throttle Cable	Cavo Acceleratore	Cable, Accelérateur	Gashebel Kabel	Honda - GGP
12	181005519/0	1	Throttle Cable	Cavo Acceleratore	Cable, Accelérateur	Gashebel Kabel	GGP 100cc

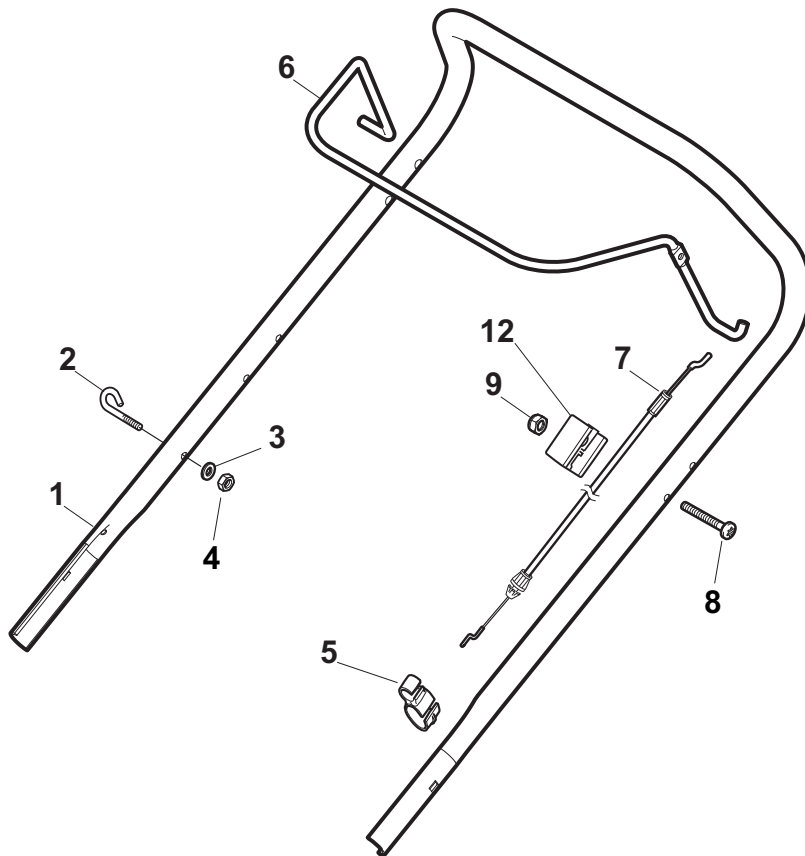

POS	PART. NO	Q.ty	DESCRIPTION	DESCRIZIONE	DESCRIPTION	BESCHREIBUNG	REMARKS
1	381006739/0	1	Handle, Upper Part	Manico, Parte Sup	Mancheron, Partie Superieure	Holm, Oberteil	
1	381006745/0	1	Handle, Upper Part with sponge handgrip	Manico, Parte Sup. con impugantura in spugna	Mancheron, Partie Superieure avec éponge poignée	Holm, Oberteil Handgriff Schwamm	
2	122430313/0	1	Guide Spring	Molla Guida	Ressort De Guide	Feder Führer	
3	112521330/0	1	Washer	Rosetta	Rondelle	Scheibe	
4	112154510/0	1	Nut	Dado	Ecrou	Mutter	
5	118390020/0	1	Fairlead	Fermacavo	Fixation Cable	Kabelbefestigung	
6	181003363/1	1	Lever, Engine Brake Black	Leva Freno Motore Nero	Levier Frein Moteur Noir	Hebel, Motorbremse Schwarz	
6	381003365/0	1	Lever, Engine Brake Yellow	Leva Freno Motore, Giallo	Levier Frein Moteur Jaune	Hebel, Motorbremse, Gelb	
6	381003376/0	1	Lever, Engine Brake Red	Leva Freno Motore, Rosso	Levier Frein Moteur Rouge	Hebel, Motorbremse, Rot	
7	181030053/0	1	Cable, Thread Engine Brake	Cavo Freno Motore	Cable Frein Moteur	Kabel, Motorbremse	Honda - B&S
7	181030054/0	1	Cable, Thread Engine Brake	Cavo Freno Motore	Cable Frein Moteur	Kabel, Motorbremse	Sumec
7	181030087/0	1	Cable, Thread Engine Brake	Cavo Freno Motore	Cable Frein Moteur	Kabel, Motorbremse	GGP 100cc
8	112727783/0	1	Screw	Vite	Vis	Schraube	
9	112154510/0	1	Nut	Dado	Ecrou	Mutter	
12	322551640/0	1	Plate	Piastrina	Plaquette	Plättchen	

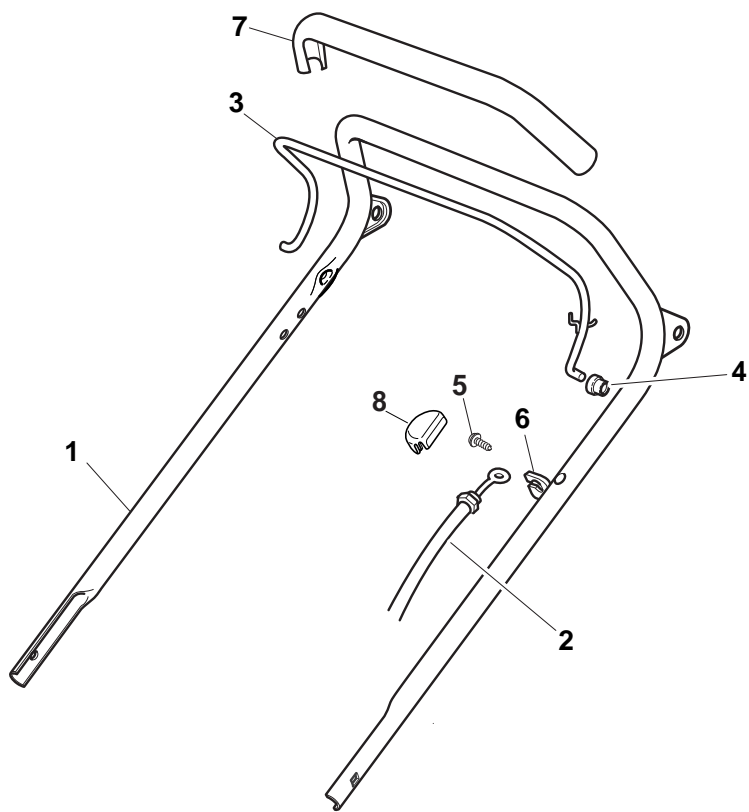

POS	PART. NO	Q.ty	DESCRIPTION	DESCRIZIONE	DESCRIPTION	BESCHREIBUNG	REMARKS
1	381007018/1	1	Handle, Upper Part	Manico, Parte Sup	Mancheron, Partie Superieure	Holm, Oberteil	
2	181000622/2	1	Cable, Thread Engine Brake	Cavo Freno Motore	Cable Frein Moteur	Kabel, Motorbremse	Sumec
2	181000616/1	1	Cable, Thread Engine Brake	Cavo Freno Motore	Cable Frein Moteur	Kabel, Motorbremse	Honda - GGP - B&S
3	181003291/3	1	Lever, Engine Brake	Leva Freno Motore	Levier Frein Moteur	Hebel, Motorbremse	
4	122041966/0	2	Bush	Bussola	Douille	Büchse	
5	112728518/0	1	Screw	Vite	Vis	Schraube	
6	322806612/0	1	Support	Supporto	Support	Halter	
7	122291050/0	1	Handgrip Black	Impugnatura Manico Nera	Poignée Noir	Handgriff Schwarz	
8	122601000/0	1	Protection	Protezione	Protection	Schutz	

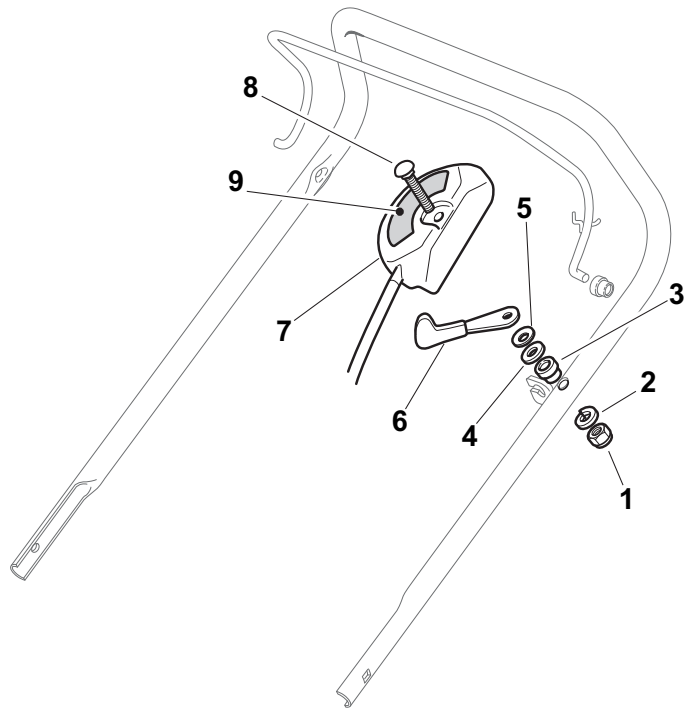

POS	PART. NO	Q.ty	DESCRIPTION	DESCRIZIONE	DESCRIPTION	BESCHREIBUNG	REMARKS
1	112291000/0	1	Nut	Dado	Ecrou	Mutter	
2	112581500/0	1	Grower	Grower	Grower	Federring	
3	122171005/0	1	Spacer	Distanziale	Entretoise	Distanzring	
4	112521360/0	1	Washer	Rosetta	Rondelle	Scheibe	
5	112508100/0	1	Spring Washer	Rosetta Elastica	Rondelle Elastique	Elastische Scheibe	
6	381007220/0	1	Lever, Throttle	Leva, Acceleratore	Levier, Accelérateur	Hebel, Beschleuniger	B&S450-500 / GGP 150cc
6	381007279/1	1	Lever, Throttle	Leva, Acceleratore	Levier, Accelérateur	Hebel, Beschleuniger	GGP - Honda - B&S
7	481007080/0	1	Throttle Cable	Cavo Acceleratore	Cable, Accelérateur	Gashebel Kabel	
8	112815000/0	1	Screw	Vite	Vis	Schraube	
9	114356702/0	1	Label	Etichetta	Etiquette	Etikette	Honda - GGP
9	114356703/0	1	Label	Etichetta	Etiquette	Etikette	B&S
9	114356905/0	1	Label	Etichetta	Etiquette	Etikette	B&S DOV
9	114356905/0	1	Label	Etichetta	Etiquette	Etikette	Honda Autochocke

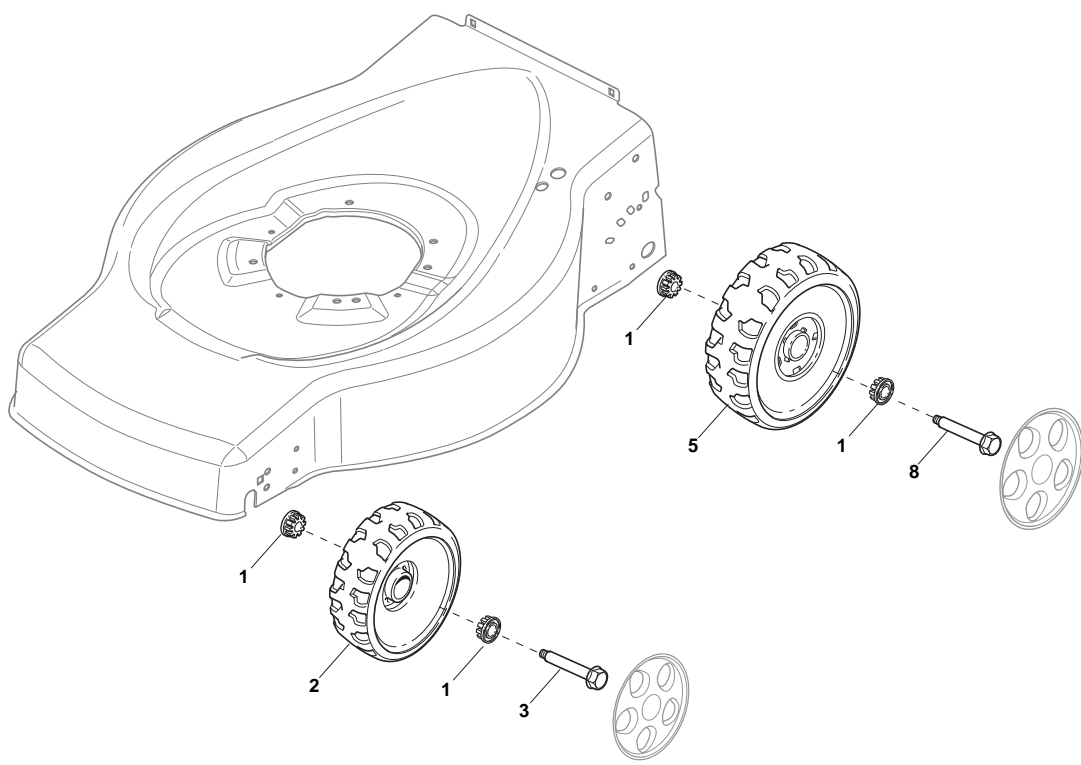



POS	PART. NO	Q.ty	DESCRIPTION	DESCRIZIONE	DESCRIPTION	BESCHREIBUNG	REMARKS
1	122034508/0	8	Bush	Bussola	Douille	Büchse	
2	322686091/1	2	Wheel Ø 165	Ruota Ø 165	Roue Ø 165	Rad Ø 165	
3	122524341/0	4	Pin	Perno	Pivot	Bolzen	
5	322686092/0	2	Wheel Ø 190	Ruota Ø 190	Roue Ø190	Rad Ø 190	
8	122524341/0	2	Pin	Perno	Pivot	Bolzen	

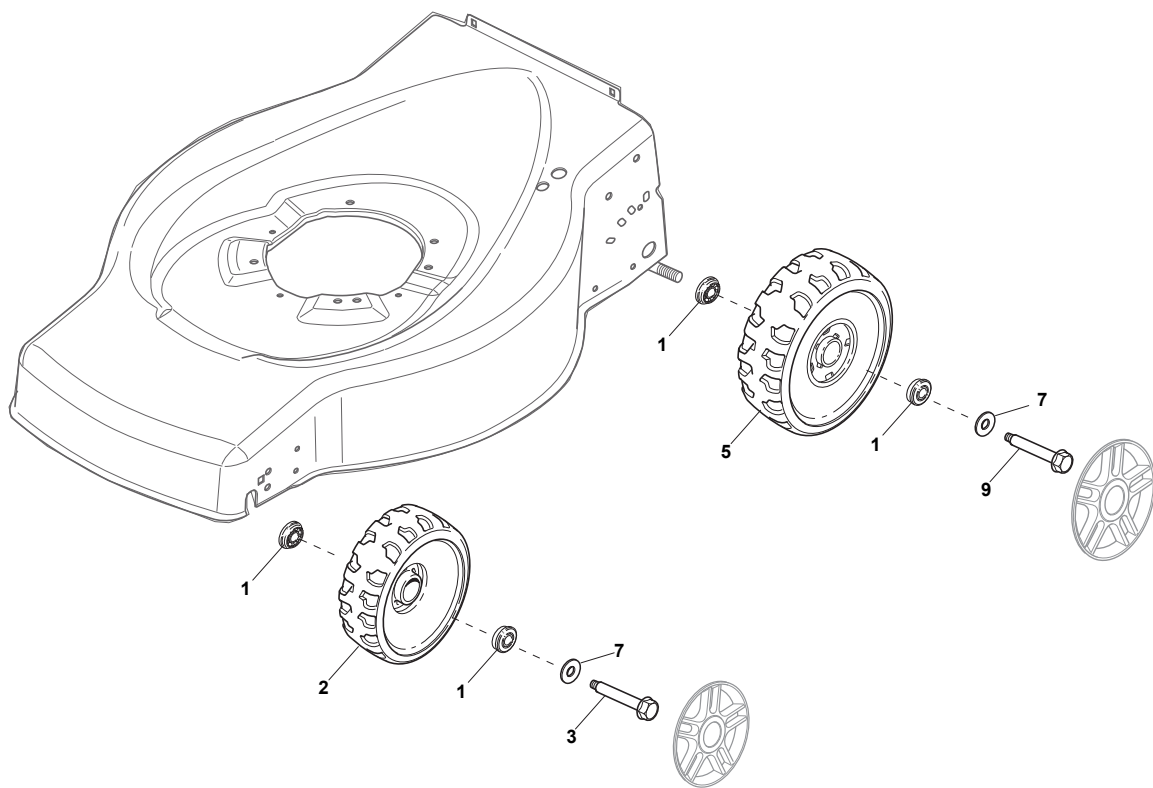

POS	PART. NO	Q.ty	DESCRIPTION	DESCRIZIONE	DESCRIPTION	BESCHREIBUNG	REMARKS
1	122122200/0	8	Bearing	Cuscinetto	Coussinet	Lager	
2	322686091/1	2	Wheel Ø 165	Ruota Ø 165	Roue Ø 165	Rad Ø 165	
3	122524341/0	4	Pin	Perno	Pivot	Bolzen	
5	322686092/0	2	Wheel Ø 190	Ruota Ø 190	Roue Ø190	Rad Ø 190	
7	122675100/0	4	Washer	Rosetta	Rondelle	Scheibe	
9	112735599/0	2	Screw	Vite	Vis	Schraube	

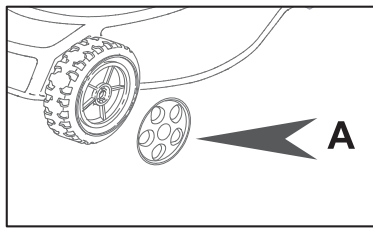
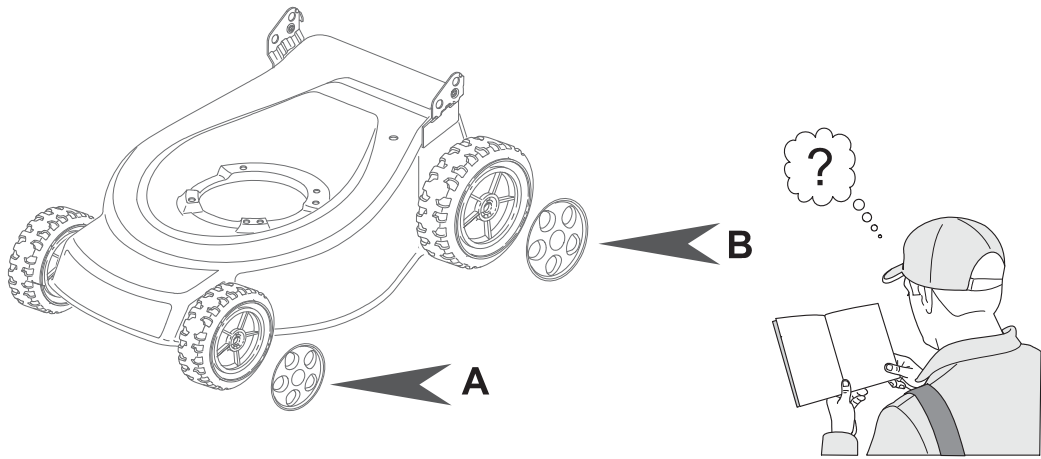

+

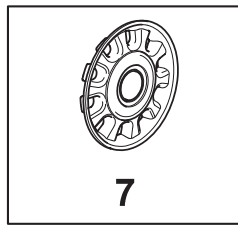

= A7

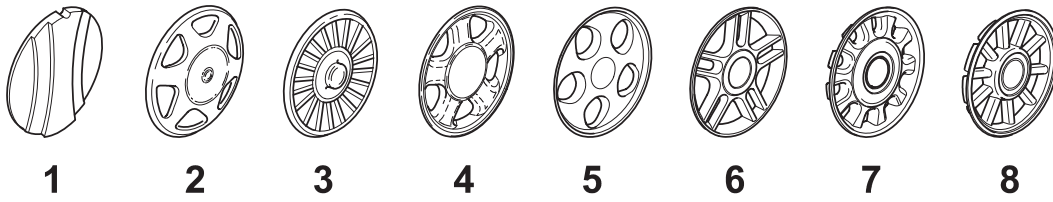

POS	PART. NO	Q.ty	DESCRIPTION	DESCRIZIONE	DESCRIPTION	BESCHREIBUNG	REMARKS
A1	22110252/1	2	Hub Cap White	Coprimito Bianco	Couvre-Moyeu Blanc	Radkappe Weiß	
A1	22110254/1	2	Hub Cap Yellow	Coprimito Giallo	Couvre-Moyeu Jaune	Radkappe Gelb	
A1	22110255/1	2	Hub Cap Red	Coprimito Rosso	Couvre-Moyeu Rouge	Radkappe Rot	
A2	22110344/0	2	Hub Cap White	Coprimito Bianco	Couvre-Moyeu Blanc	Radkappe Weiß	
A2	22110395/0	2	Hub Cap Grey	Coprimito Grigio	Couvre-Moyeu Gris	Radkappe Grau	
A3	22110347/0	2	Hub Cap Grey	Coprimito Grigio	Couvre-Moyeu Gris	Radkappe Grau	
A4	22110381/0	2	Hub Cap Grey	Coprimito Grigio	Couvre-Moyeu Gris	Radkappe Grau	
A5	22110416/0	2	Hub Cap Grey	Coprimito Grigio	Couvre-Moyeu Gris	Radkappe Grau	
A6	22110491/0	2	Hub Cap Grey	Coprimito Grigio	Couvre-Moyeu Gris	Radkappe Grau	
A7	22110493/0	2	Hub Cap Grey	Coprimito Grigio	Couvre-Moyeu Gris	Radkappe Grau	
A8	22110495/0	2	Hub Cap Grey	Coprimito Grigio	Couvre-Moyeu Gris	Radkappe Grau	
B1	22110251/0	2	Hub Cap White	Coprimito Bianco	Couvre-Moyeu Blanc	Radkappe Weiß	
B1	22110253/0	2	Hub Cap Yellow	Coprimito Giallo	Couvre-Moyeu Jaune	Radkappe Gelb	
B1	22110256/0	2	Hub Cap Grey	Coprimito Grigio	Couvre-Moyeu Gris	Radkappe Grau	
B2	22110313/0	2	Hub Cap White	Coprimito Bianco	Couvre-Moyeu Blanc	Radkappe Weiß	
B2	22110314/0	2	Hub Cap Grey	Coprimito Grigio	Couvre-Moyeu Gris	Radkappe Grau	
B3	22110348/0	2	Hub Cap Grey	Coprimito Grigio	Couvre-Moyeu Gris	Radkappe Grau	
B4	22110382/0	2	Hub Cap Grey	Coprimito Grigio	Couvre-Moyeu Gris	Radkappe Grau	
B5	22110417/0	2	Hub Cap Grey	Coprimito Grigio	Couvre-Moyeu Gris	Radkappe Grau	
B6	22110492/0	2	Hub Cap Grey	Coprimito Grigio	Couvre-Moyeu Gris	Radkappe Grau	
B7	22110494/0	2	Hub Cap Grey	Coprimito Grigio	Couvre-Moyeu Gris	Radkappe Grau	
B8	22110496/0	2	Hub Cap Grey	Coprimito Grigio	Couvre-Moyeu Gris	Radkappe Grau	

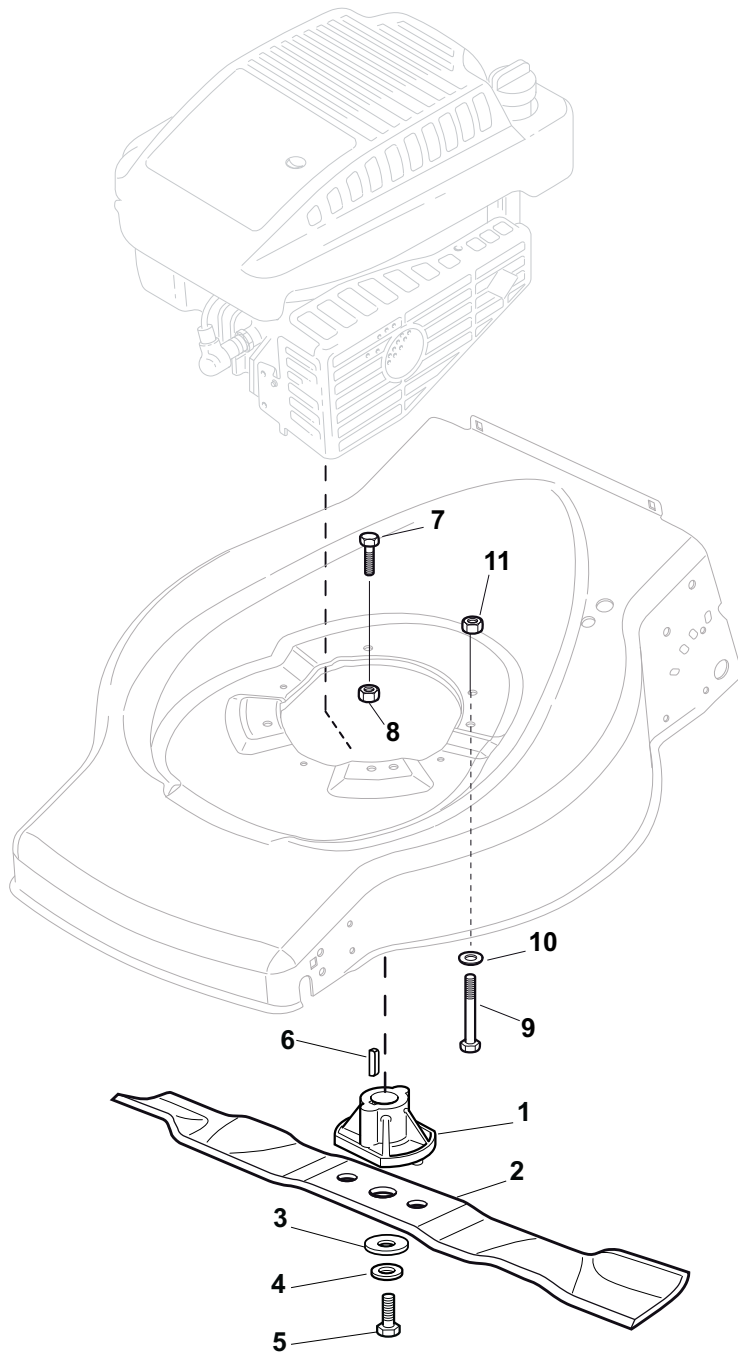

POS	PART. NO	Q.ty	DESCRIPTION	DESCRIZIONE	DESCRIPTION	BESCHREIBUNG	REMARKS
1	122463012/2	1	Hub, Crankshaft Ø 22.2	Mozzo, Albero Motore Ø 22.2	Moyeu, Arbre Moteur Ø 22.2	Nabe, Motorwelle Ø 22.2	B&S-GGP
1	122463020/1	1	Hub, Crankshaft Ø 25	Mozzo, Albero Motore Ø 25	Moyeu, Arbre Moteur Ø 25	Nabe, Motorwelle Ø 25	Honda
2	181004365/3	1	Blade	Coltello	Lame	Messer	
3	122160400/0	1	Elastic Washer	Disco Elastico	Disque Elastique	Federscheibe	
4	112523080/0	1	Washer	Rosetta	Rondelle	Scheibe	
5	112735698/0	1	Screw	Vite	Vis	Schraube	
6	112139100/0	1	Feather, Crankshaft Ø 22.2	Linguetta, Albero Motore Ø 22.2	Clavette, Arbre Moteur Ø 22.2	Keil, Motorwelle Ø 22.2	B&S-GGP
6	112139150/0	1	Feather, Crankshaft Ø 25	Linguetta, Albero Motore Ø 25	Clavette, Arbre Moteur Ø 25	Keil, Motorwelle Ø 25	Honda
7	112793701/0	2	Screw	Vite	Vis	Schraube	
8	112293201/0	2	Nut	Dado	Ecrou	Mutter	
9	112691800/0	1	Screw	Vite	Vis	Schraube	
10	112521350/0	1	Washer	Rosetta	Rondelle	Scheibe	
11	112155000/0	1	Nut	Dado	Ecrou	Mutter	

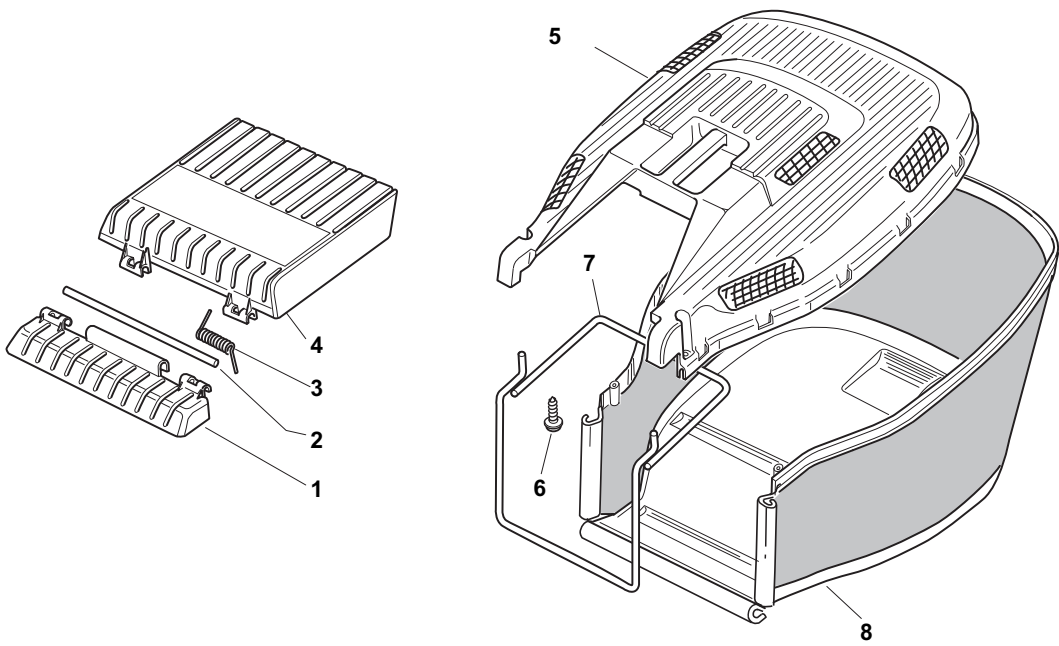



POS	PART. NO	Q.ty	DESCRIPTION	DESCRIZIONE	DESCRIPTION	BESCHREIBUNG	REMARKS
1	322785136/1	1	Support	Supporto	Support	Halter	
2	122517858/0	1	Pin	Perno	Pivot	Bolzen	
3	122450431/0	1	Spring	Molla	Ressort	Feder	
4	322600099/2	1	Stone-Guard	Parasassi	Pare-Pierres	Prallblech	
5	322486122/0	1	Grassbox Upper Part	Parte Sup.Sacco	Sac, Partie Superieure	Korb Oberteil	
6	112728686/0	2	Screw	Vite	Vis	Schraube	
7	181006419/0	1	Chassis Box	Telaio Sacco	Châssis Bac	Rahmen Sack	
8	181002229/0	1	Box, Fabric	Sacco, Tela	Sac, Toile	Sack, Tuck	

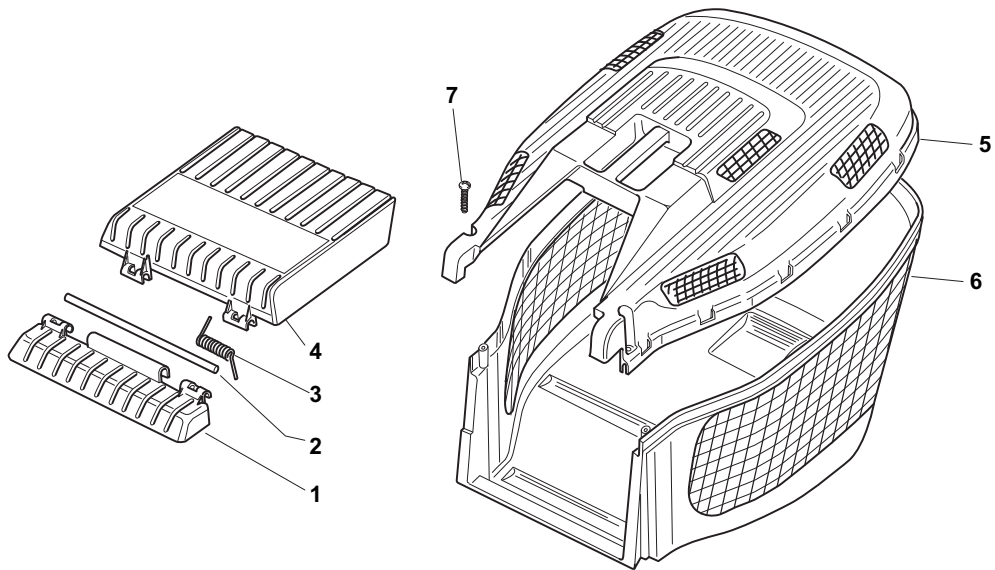

POS	PART. NO	Q.ty	DESCRIPTION	DESCRIZIONE	DESCRIPTION	BESCHREIBUNG	REMARKS
1	322785136/1	1	Support	Supporto	Support	Halter	
2	122517858/0	1	Pin	Perno	Pivot	Bolzen	
3	122450431/0	1	Spring	Molla	Ressort	Feder	
4	322600099/2	1	Stone-Guard	Parasassi	Pare-Pierres	Prallblech	
5	322486122/0	1	Grassbox Upper Part	Parte Sup.Sacco	Sac, Partie Superieure	Korb Oberteil	
6	322486128/0	1	Grassbox Lower Part	Parte Infer. Sacco	Sac, Partie Inferieure	Korb Unterteil	
7	112728686/0	2	Screw	Vite	Vis	Schraube	