



Green Passion

Illustrated Parts List

XHM 75 - Model Year 2009

- Use GLOBAL GARDEN PRODUCT Genuine Spare Parts specified in the parts list for repair and/or replacement.
- The contents described in the parts list may change due to improvement.
- The drawings of the spare parts are only indicative and might not represent the part in question exactly.
- The indications "right" - "left" - "front" - "rear" refer to the position of the operator when using the machine.
- When placing orders of parts for repair and/or replacement, make sure that the illustrated parts list is the one applying to the machine's year of manufacture, as shown on the identification plate attached to the machine.

COPYRIGHT by GLOBAL GARDEN PRODUCTS

All rights reserved. No part of this material may be reproduced or transmitted, in any form or by any means, electronic or mechanical, including photocopying, recording or by any information storage and retrieval system, without permission in writing from GLOBAL GARDEN PRODUCTS.

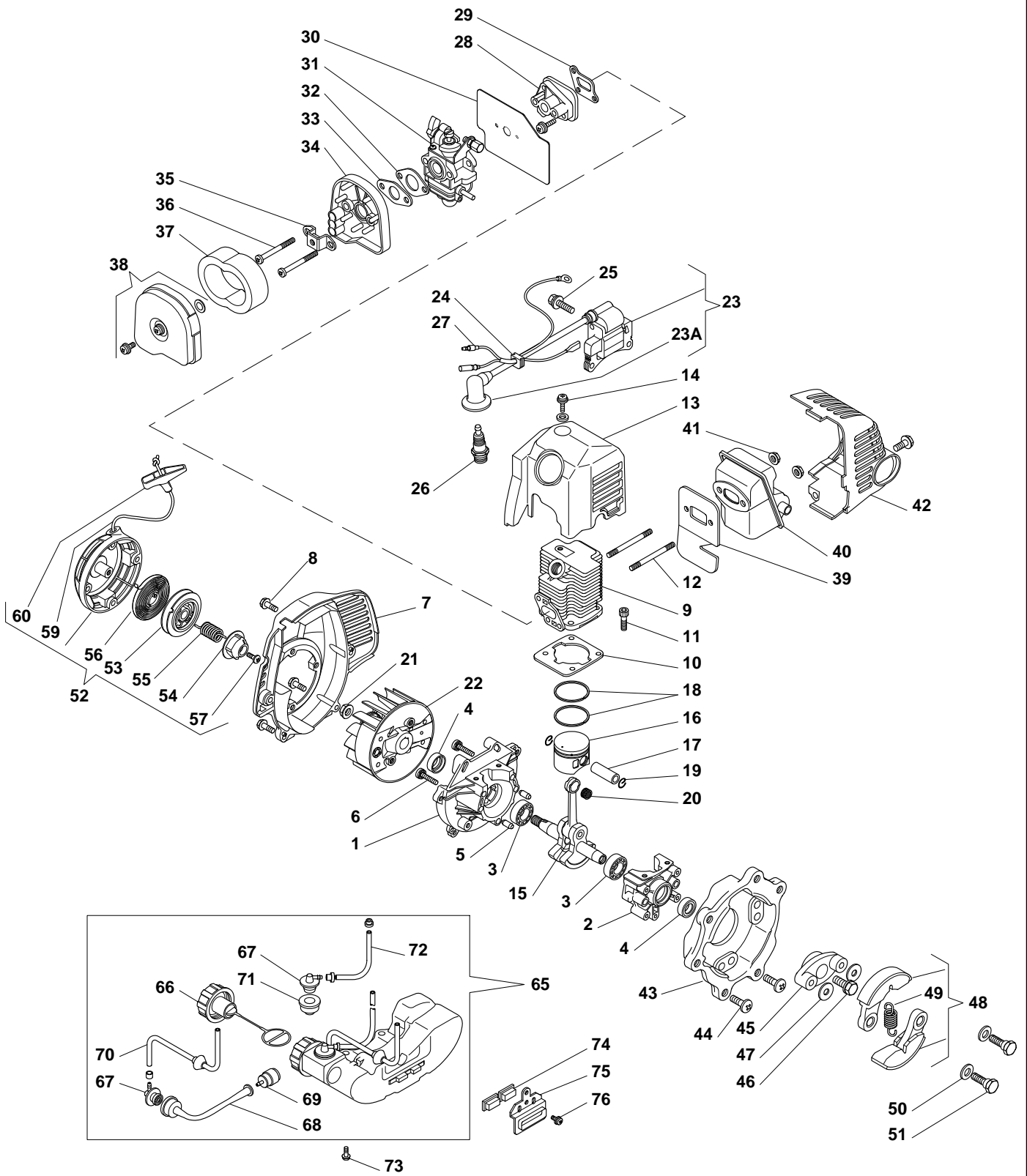



XHM 75 - Model Year 2009

Engine

Pos.	Part no.	Q.ty	Description	Remarks
1	123685014/0	1	Crank Case	
2	123685015/0	1	Crank Case	
3	114215220/0	2	Bearing	
4	119035160/0	2	Seal Ring	
5	123753002/0	2	Pin	
6	123878066/0	3	Screw	
7	123107506/0	1	Engine Cover Red	
8	123878095/0	4	Screw	
9	123071022/0	1	Cylinder	
10	123280069/0	1	Cylinder Gasket	
11	123878096/0	4	Screw	
12	123878061/0	2	Double-Screw Bolt	
13	123106033/0	1	Engine Cover Red	
14	123878097/0	1	Screw	
15	123020031/0	1	Crankshaft	
16	123590013/0	1	Piston	
17	123760001/0	1	Piston Pin	
18	123204015/0	2	Piston Ring	
19	123202002/0	2	Washer, Piston Pin	
20	123235003/0	1	Needle Bearing	
21	123120005/0	1	Nut	
22	123880013/0	1	Flywheel Ass.Y	
23A	123053002/0	1	Spark Plug Cover	
23	183044002/0	1	Ignition Ass'Y	
24	123275029/0	1	Grommet	
25	123878064/0	2	Screw	
26	3210024	1	Spark Plug	
27	123065043/0	1	Earth Cable	
28	123073517/0	1	Intake Manifold	
29	123280070/0	1	Intake Manif-Gasket	
30	123280071/0	1	Intake-Carb Gasket	
31	123054035/0	1	Carburettor	
32	123208413/0	1	Spacer	
33	123280072/0	1	Gasket	
34	123040004/0	1	Air Cleaner Base	
35	123208414/0	1	Steam	
36	123878098/0	2	Screw	
37	123220016/0	1	Air Filter	
38	183090014/0	1	Filter Cover	
39	123280073/0	1	Gasket	
40	183740019/0	1	Muffler	
41	123120011/0	2	Nut	
42	123600077/0	1	Muffler Shield, Red	
43	123208415/0	1	Flange	
44	123878099/0	4	Screw	
45	123445263/0	1	Clutch-Mass Guide Plate	
46	123878100/0	1	Screw	
47	123657015/0	2	Washer	
48	183215009/0	1	Clutch Ass.Y	
49	123430600/0	1	Spring	
50	123657016/0	2	Washer	
51	123878101/0	2	Screw	
52	183058039/0	1	Starter Ass.Y	
53	123604012/0	1	Starter Pulley	
54	123445265/0	1	Plate	
55	123430601/0	1	Spring	
56	123430602/0	1	Spring	
57	123878102/0	1	Screw	
59	123234006/0	1	Starter Cord	
60	123300007/0	1	Starter Handle	
65	183733008/0	1	Kit Fuel Tank	
66	183790008/0	1	Fuel Cap Ass.Y	
67	123650006/0	2	Grommet	
68	123867025/0	1	Fuel Line	
69	183520004/0	1	Intake Filter	
70	123867026/0	1	Tube	



XHM 75 - Model Year 2009

Engine

Pos.	Part no.	Q.ty	Description	Remarks
71	123671501/0	1	Grommet	
72	123867027/0	1	Tube	
73	123878103/0	2	Screw	
74	123275030/0	2	Grommet	
75	123208417/0	1	Support	
76	123878104/0	1	Screw	

Cutting unit

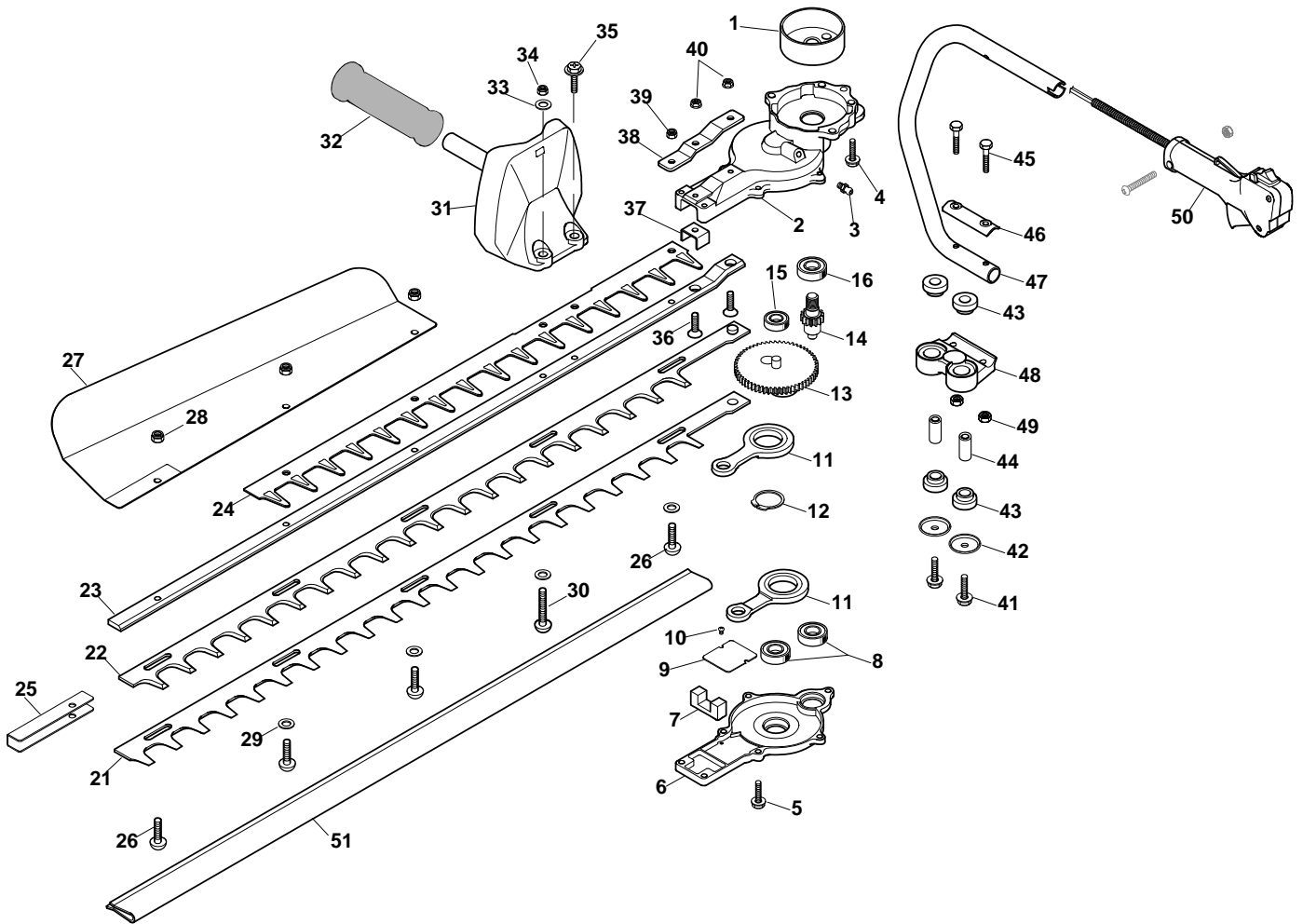



XHM 75 - Model Year 2009

Cutting unit

Pos.	Part no.	Q.ty	Description	Remarks
1	123050009/0	1	Drum Ass'Y, Clutch	
2	6990199	1	Upper Case	
3	6990153	1	Grease Dispenser	
4	6990205	3	Screw	
5	6990141	7	Screw	
6	6990200	1	Lower Case	
7	6990202	1	Gasket	
8	6990151	2	Bearing	
9	6990183	1	Shoe	
10	6990139	2	Screw	
11	6990157	2	Connecting Rod	
12	6990150	1	Elastic Ring	
13	6990186	1	Sprocket	
14	6990193	1	Pinion	
15	6990151	1	Bearing	
16	6990152	1	Bearing	
21	6990182	1	Bottom Blade	
22	6990181	1	Top Blade	
23	6990192	1	Blade Holder	
24	6990198	1	Blade Guard	
25	6990180	1	Blades Holder Plate	
26	6990196	4	Screw	
27	6990184	1	Deflector	
28	6990146	3	Nut	
29	6990121	4	Washer	
30	6990197	1	Screw	
31	6990194	1	Fore Handle	
32	6990179	1	Knob	
33	6990210	1	Washer	
34	6990146	1	Nut	
35	6990207	1	Screw	
36	6990204	2	Screw	
37	6990128	1	Retainer	
38	6990201	1	Plate	
39	6990146	1	Nut	
40	6990209	2	Nut	
41	6990206	2	Screw	
42	6990191	2	Cap	
43	6990189	4	Grommet	
44	6990188	2	Spacer	
45	6990211	2	Screw	
46	6990190	1	Handle Fixing Plate	
47	6990203	1	Handle	
48	6990187	1	Handle Support	
49	6990208	2	Nut	
50	183300024/0	1	Hind Handle Assy	
51	6990195	1	Blade Cover	