

M150  
SV150

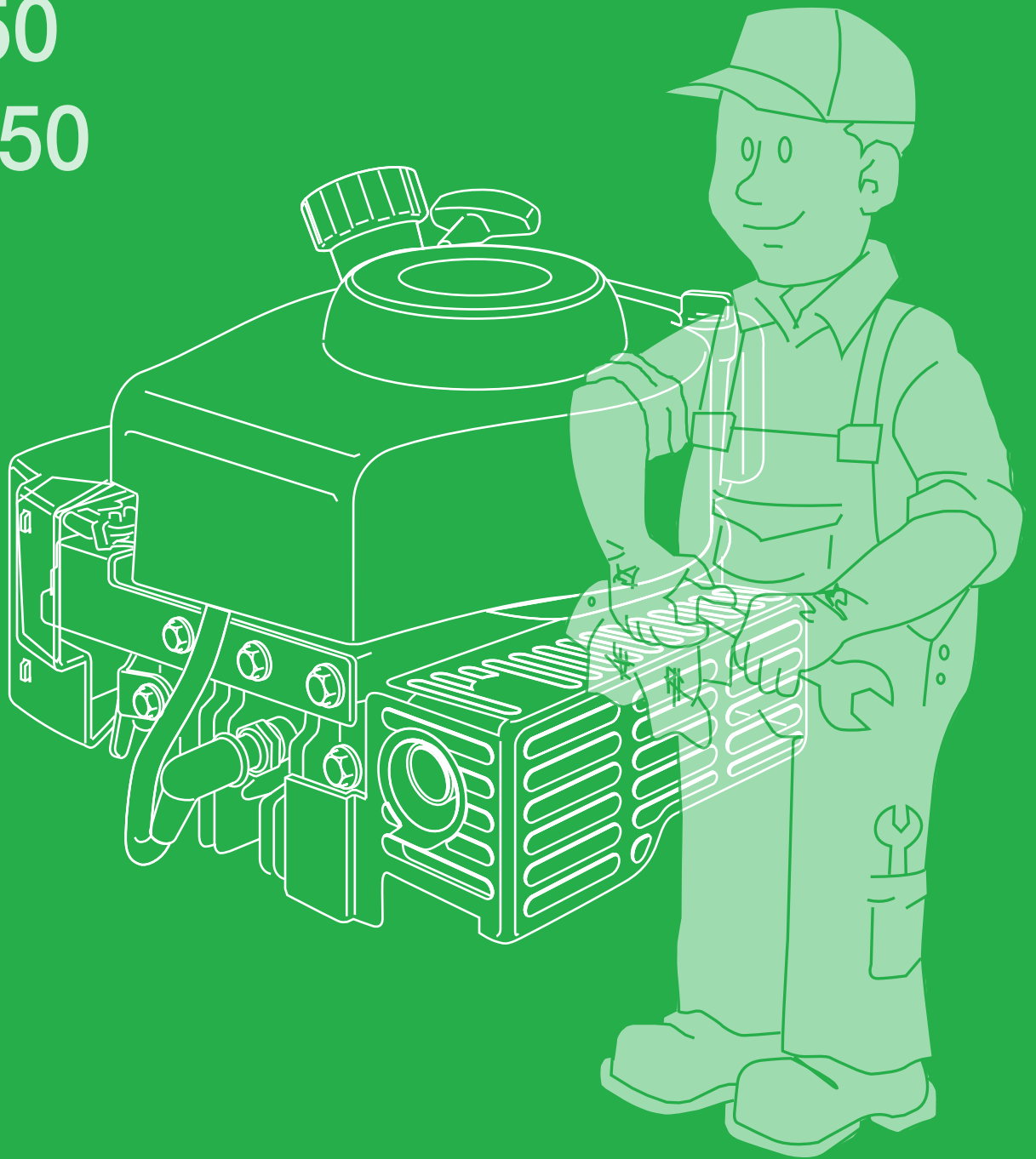

  
**GGP** ENGINE TECHNOLOGY

Workshop manual

2007

# **SV150**

# **M150**

# **SERVICE**

# **MANUAL**

**Rel. 2.0 - 4/2007**

The manufacturer reserves the right to make all the necessary technical or commercial improvements to its products, so there may be some differences between the series of engines and the contents of this manual. However the basic specifications and different operating procedures will remain the same.

© by GLOBAL GARDEN PRODUCTS No use of the illustrations or duplication, reproduction or translation, even partial, of the texts in this document may be made without explicit authorization.

|  |        |                            |
|--|--------|----------------------------|
| <b>i.1</b><br><b>TABLE OF CONTENTS</b> | ▶<br>▶ | from 2004 to<br>page 1 / 1 |
|--|--------|----------------------------|

## MAIN CHAPTERS

### 1. Rules and procedures for Service Centres

*This chapter covers all the main aspects of the relationship between the manufacturer and the service centres.*

*A close collaboration between the manufacturer and the service centres is conclusive for solving problems in the most effective way as well as maintaining an image of efficiency and reliability. Compliance with these brief and simple guidelines will facilitate this task and prevent general misunderstandings and time-wasting for both the manufacturer and the service centre.*

### 2. General and safety regulations

*This chapter covers the main aspects of a servicing procedure and the general rules for guaranteeing a successful service which protects the environment and respects the safety of both the serviceman and the user of the apparatus.*

### 3. Technical data and specifications

*This chapter summarizes all the technical information regarding the engine, tuning data, tight-*

*ening torques, expendable materials and spare parts available.*

### 4. Engine tuning

*This chapter describes how to plan a maintenance program and outlines a servicing procedure for general engine tuning.*

### 5. Troubleshooting

*This chapter summarizes all the main operating faults and indicates probable causes and procedures for solving them.*

### 6. Servicing procedures

*This chapter describes the servicing procedures for dealing with the most frequent operating faults.*

*The descriptions follow a logical sequence and may cover operations not strictly linked to the one described.*

*In this case, you should read the entire procedure carefully so that you can leave out any irrelevant operations without missing necessary steps.*

## CONTENTS

|     |   |  |
|-----|---|--|
| ii  | 1 | Introduction                             |
| 1.1 | 0 | Rules and procedures for Service Centres |
| 2.1 | 0 | General and safety regulations           |
| 3.1 | 1 | Technical data and specifications        |
| 4.1 | 0 | Testing and tuning the engine            |
| 5.1 | 1 | Troubleshooting                          |
| 6.1 | 1 | Tank and supply                          |
| 6.2 | 1 | Starting system                          |
| 6.3 | 1 | Intake system                            |
| 6.4 | 1 | Carburation                              |
| 6.5 | 1 | Carburettor governor system              |
| 6.6 | 1 | Ignition system                          |
| 6.7 | 1 | Turning off and stopping the engine      |
| 6.8 | 1 | Exhaust system                           |
| 6.9 | 1 | Engine block                             |

|                                     |   |
|-------------------------------------|---|
| <p>ii.1<br/><b>INTRODUCTION</b></p> | <p>from 2007 to</p> <hr/> <p>page 1 / 1</p> |
|-------------------------------------|---|

## INTRODUCTION

The purpose of this manual is to help Service Centres service, disassemble and repair SV150 engines.

Each page of this manual states the following information:

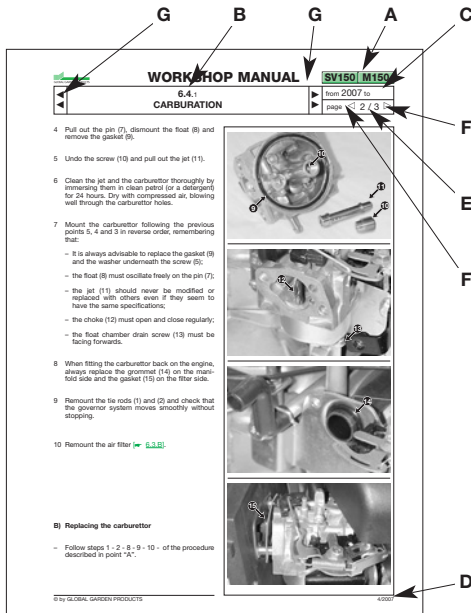

- A)** Engine type or types the page is referring to.
- B)** Page number, specifically:
  - the first two figures separated by a point indicate the section and the chapter
  - the third figure indicates the modification index.
- C)** Temporary validity of the page, with reference to the year of manufacture [ 3.1.A ] or serial numbers.
- D)** Date of release.
- E)** Page number and total number of pages dedicated to the subject.
- F)** Any previous or ensuing pages dedicated to the subject.
- G)** Any chapters before or after the current one.

The manual refers to the following symbols:

Warns of operations that should be carried out with utmost care to avoid impairing the functionality and safety of the lawnmower.

Warns of operations that should be carried out with utmost care to avoid injury to the operator.

Shows all the operations requiring different intervention methods depending on the engine version.

Shows all the operations requiring different intervention methods depending on the engine version.

**NOTE**  
All references to “right”, “left”, “front”, “rear”, “upper” and “lower” refer to the engine installed on the lawnmower and viewed from the user’s operating position.

The manual has left out the simplest and quickest operations that can be handled by a good mechanic, while concentrating more on specific aspects and the best servicing procedures.

Please read all the contents of this manual to become familiar with the basics of the engine, which is fundamental for operating in a logical manner without making errors or wasting time.

All problems related to use are fully covered in the user manual.

|   |              |
|---|--------------|
| 1.1.0   | from 2004 to |
| <b>RULES AND PROCEDURES FOR SERVICE CENTRES</b> | page 1 / 1   |

## 1.1 RULES AND PROCEDURES FOR SERVICE CENTRES

### A) Warranty validity

The warranty is supplied under the terms, procedures and limits stated in the contract.

### B) Post-warranty assistance

The Service Centre is obliged to compile a report for every service, stating the engine serial number [[↔ 3.1.A](#)], the summary of claims, the operation carried out and any spare parts used.

A copy of these reports must be kept and made available to the manufacturer together with the replaced parts, in case clients should make further complaints.

### C) Fault notification

The manufacturer should be informed of all faults that recur frequently; this allows it to carefully examine the problem and make corrections on the production line.

Similarly, the manufacturer shall report any faults traced on its engines, indicating the best troubleshooting procedure.

### D) Requesting spare parts

When asking for spare parts, you must quote their code by referring to the exploded views corresponding to the year of manufacture reported on the nameplate [[↔ 3.1.A](#)].

|                                       |              |
|---------------------------------------|--------------|
| 2.1.0                                 | from 2004 to |
| <b>GENERAL AND SAFETY REGULATIONS</b> | page 1 / 1   |

## 2.1 GENERAL AND SAFETY REGULATIONS

### A) Qualification of operators

All maintenance, disassembly and repairs must be carried out by expert mechanics who are familiar with all the accident prevention and safety regulations after reading through the procedures in this manual.

### B) Safety measures

All the engines are built in conformity with the European safety regulations in force.

To maintain initial safety levels in the long term, the Service Centre should take proactive measures by making checks whenever possible.

Every time you are asked to service the engine (or the lawnmower on which it is installed), you should:

#### 1) check:

- that the safety devices function correctly;
- that the guards and covers have not been removed;
- that the nameplates or specification labels have not been removed or made illegible, as they form an integral part of the safety devices.

#### 2) also:

- make sure the safety devices function correctly if they have been tampered with or removed;
- replace ineffective, damaged or missing guards and covers;
- replace illegible labels;
- do not carry out operations or modifications on the lawnmower or on the engine that could affect their performance or lead to an improper or different use from the one for which it has been designed and approved;
- warn the customer that the failure to comply with the above points automatically voids the warranty and the responsibility of the manufacturer.

### C) Precautions during servicing

The operations described in this manual do not entail particularly hazardous situations besides the

normal hazard related to mechanical operations and that can be avoided by taking the necessary care and attention normally required for this type of work.

As well as following the usual accident prevention regulations that apply to most repair shops, we recommend you:

- disconnect the spark plug cap before servicing;
- protect hands with suitable working gloves, especially when working near the cutting unit;
- check that you do not cause accidental petrol leaks or other losses;
- do not smoke when working on the tank or when handling petrol;
- do not inhale oil or petrol fumes;
- clean up all traces of spilt petrol immediately;
- test the engine in a well-ventilated environment or where there are adequate exhaust fume extraction systems;
- do not pollute the environment with oil, petrol or other waste and dispose of all waste in accordance with the laws in force.

### D) Necessary equipment

All the operations can be carried out with the tools normally used in a good garage.

Some operations require special equipment and tools [\[→ 3.1.F\]](#).

### E) Symbols and terms used for safety purposes

Some paragraphs in this manual are preceded by symbols which indicate the following:



Operations that should be carried out with utmost care to avoid impairing the functionality and safety of the engine and/or lawnmower on which it is installed.



Operations that should be carried out with utmost care to avoid injury to operators.

**“WARNING”** stresses the risk of injury to oneself and others if instructions and regulations are not observed.





|                                  |              |
|----------------------------------|--------------|
| 4.1.0                            | from 2004 to |
| <b>ENGINE TUNING AND TESTING</b> | page 1 / 1   |

## 4.1 ENGINE TUNING AND TESTING

### A) Operating guidelines

The instruction manual describes a series of operations for the client to ensure minimum basic maintenance. For operations beyond the client's capability, the Service Centre should see to keeping the engine in perfect working order by:

- Tuning the engine whenever possible.
- Recommending the client a routine maintenance program at set intervals (e.g. at the end of the season or before a long period of inactivity).

### B) Engine tuning program

Whenever the Service Centre is asked to service a lawnmower or tune an engine, it should follow a series of operations to ensure the engine is kept fully serviceable.

Tuning should involve:

- external blowing and cleaning the cylinder head, cylinder and muffler by removing any remains of grass and mud;
- checking the oil level, topping up or replacing parts if necessary;
- inspecting the condition of the starter cable and checking that it functions correctly;
- cleaning and maintenance the air filter [\[↔ 6.3\]](#);
- emptying and cleaning the fuel tank and checking the breather pipe [\[↔ 6.1\]](#);
- adjusting minimum and maximum speeds [\[↔ 6.4 and 6.5\]](#);
- inspecting the condition of the spark plug and ignition cable; checking the distance between the electrodes [\[↔ 6.6\]](#);
- tightening the screws [\[↔ 6.9\]](#);
- functional test [\[↔ point "C"\]](#).

Should the checks and adjustments fail to achieve a satisfactory result, refer to chapter 5 for troubleshooting.

### C) Functional test

A functional test needs to be carried out at the end of each servicing operation, to check that the operations made are effective. The test must be performed in compliance with the safety regulations regarding the use of the lawnmower on which the engine is installed.

The functional test is carried out as follows.

**1. Refuelling and checking the supply system.** When you have refuelled the tank with new petrol, check the seal of the tank, the cap and the carburettor pipe.

**2. Cold start test.** With the throttle control in "CHOKE", start the engine a few times to check it runs normally.

**3. Check the engine rpm.** When the engine is hot enough, check the engine speed with the throttle control set to "SLOW" and "FAST"; the readings should be equal to the specifications [\[↔ 3.1.B\]](#).

**4. Hot start test.** With the engine hot and the throttle control set to "SLOW", start the engine a few times to check it runs normally.

**5. Engine brake and stopping test.** If you release the lawnmower brake lever, the engine should turn off instantaneously and decisively, and the rotation should stop within 3 seconds.

If all of these operations have a positive result, the engine can be considered fully serviceable and be returned to the client.



|  |  |  |  |
|--|--|--|--|
| <br> | <b>5.1.1</b><br><b>TROUBLESHOOTING</b> | <br> | from 2007 to<br>page 1 / 5  |
|--|--|--|--|

## A) The engine does not start

| Probable cause | Comment | Solution |
|----------------|---------|----------|
|----------------|---------|----------|

### Lawnmower problems

|  |  |   |
|--|--|---|
| The engine brake cable is faulty or unfastened | The cable control does not activate the coil earth switch. | Adjust and/or replace the cable [  <a href="#">6.7.A</a> ] |
|--|--|---|



### Electrical problems

|                           |  |   |
|---------------------------|--|---|
| The microswitch is faulty | If the microswitch remains locked in the pressed position, it does not stop the coil earth connection. | Replace the microswitch [  <a href="#">6.7.B</a> ] |
|---------------------------|--|---|

|  |   |   |
|--|---|---|
| Electric current does not reach the spark plug | <p>The spark plug is badly connected, faulty or the electrodes are too far away.</p> <p>The coil is faulty and does not supply current or the air gap is too large.</p> | <p>Check the spark plug and the efficiency of the ignition system with the spark test [ <a href="#">6.6.A</a>]</p> |
|--|---|---|

### Engine block problems

|                                   |   |   |
|-----------------------------------|---|---|
| Fouling in the combustion chamber | Fouling in the combustion chamber absorbs the fresh mixture, which makes starting difficult and may impair valve closure. | Dismount the cylinder head and remove fouling [  <a href="#">6.9.A</a> ] |
|-----------------------------------|---|---|

|                       |   |   |
|-----------------------|---|---|
| Insufficient pressure | <p>The cylinder head screws can loosen causing the gasket to burn.</p> <p>The piston rings can wear out due to the passage of dust caused by an excessively dirty or unoled air filter or overheating due to the lack of oil.</p> | <p>Dismount the cylinder head and replace the gasket [ <a href="#">6.9.A</a>]</p> <p>Change the engine [ <a href="#">6.9.C</a>]</p> |
|-----------------------|---|---|

## B) The engine starts badly or kicks back

| Probable cause | Comment | Solution |
|----------------|---------|----------|
|----------------|---------|----------|

### Lawnmower problems

|                              |   |  |
|------------------------------|---|--|
| The lawnmower blade is loose | The loose blade stops the effect of the flywheel and the kick-back can make starting difficult. | Check that the lawnmower blade and hub are securely fastened |
|------------------------------|---|--|

### Intake problems

|                          |   |  |
|--------------------------|---|--|
| Air filter is clogged up | The clogged filter can thicken the mixture flooding the engine. | Check and clean the air filter [  <a href="#">6.3.A</a> ] |
|--------------------------|---|--|

|  |  |  |                                |
|--|--|--|--------------------------------|
| <br> | <b>5.1.1</b><br><b>TROUBLESHOOTING</b> | <br> | from 2007 to<br>page ◀ 2 / 5 ▶ |
|--|--|--|--------------------------------|

## Carburation problems

|  |   |  |
|--|---|--|
| <p>Carburettor is dirty</p>                  | <p>If the jet and the pipes inside the carburettor clog up, the petrol flow drops and the engine fails to function correctly.</p>   | <p>Check and clean the carburettor <a href="#">[↔ 6.4.A]</a></p>   |
| <p>Poor seal of carburettor needle valve</p> | <p>If the needle valve does not close, excess fuel in the float chamber can reach the combustion chamber through the intake manifold. This can flood the engine and be hazardous as the petrol can seep through the rings and reach the oil sump. When mixed with petrol, oil loses its lubricating properties and the engine deteriorates rapidly.</p> | <p>Clean the carburettor housing and needle valve <a href="#">[↔ 6.4.A]</a> or replace the carburettor <a href="#">[↔ 6.4.B]</a></p> |
| <p>Choke blocked</p>                         | <p>The choke can get blocked in the closed position if the mixture is too oily.</p>   | <p>Check and clean the carburettor <a href="#">[↔ 6.4.A]</a> and the choke</p>   |

## C) Starting is difficult and strains the cable

| Probable cause | Comment | Solution |
|----------------|---------|----------|
|----------------|---------|----------|

### Lawnmower problems

|   |  |   |
|---|--|---|
| <p>The lawnmower traction cable (if present) is bent, jammed or poorly adjusted</p> | <p>The engine must start with the lawnmower drive completely disengaged; a poorly adjusted cable can generate faulty resistance which makes starting more difficult.</p> | <p>Check and/or adjust the lawnmower traction cable</p> |
|---|--|---|

### Problems caused by the engine

|                                 |  |  |
|---------------------------------|--|--|
| <p>Oil in the cylinder head</p> | <p>If the engine is tilted with the spark plug at the bottom, oil may seep into the cylinder head through the rings. This causes excess pressure and a reduction of mixture in the combustion chamber.</p> | <p>Dismount the cylinder head and clean it <a href="#">[↔ 6.9.A]</a></p> |
|---------------------------------|--|--|

## D) The engine starts but does not run

| Probable cause | Comment | Solution |
|----------------|---------|----------|
|----------------|---------|----------|

### Supply problems

|   |  |   |
|---|--|---|
| <p>The tank cap has a clogged breather pipe</p> | <p>The clogged breather pipe in the tank stops the regular flow of fuel into the carburettor float chamber. When the fuel has run out in the float</p> | <p>Clean and/or replace the cap <a href="#">[↔ 6.1.C]</a></p> |
|---|--|---|

|  |   |  |                                |
|--|---|--|--------------------------------|
| <br> | <h2>5.1.1</h2> <h3>TROUBLESHOOTING</h3> | <br> | from 2007 to<br>page ◀ 3 / 5 ▶ |
|--|---|--|--------------------------------|

chamber, the engine stops. After a few minutes, the float chamber fills up and the engine is able to restart, only to stop soon after.

Fuel filter clogged

Inside the tank, the filter has a metal mesh which can clog up with dirt or with a film of old fuel.

Empty and clean the tank [[↩ 6.1.B](#)]

### Ignition problems

Insufficient or no current to the spark plug

Poor connections of the electrical cables or malfunctioning parts can cause the lawnmower to function irregularly.

Check the spark plug and the efficiency of the ignition system with the spark test [[↩ 6.6.A](#)]

### E) The engine is inefficient (insufficient power)

| Probable cause | Comment | Solution |
|----------------|---------|----------|
|----------------|---------|----------|

### Lawnmower problems

The throttle cable is not well adjusted

The throttle's "FAST" position may not correspond with the carburettor's "FAST" position, reducing the flow of mixture and hence the power.

Check and/or adjust the throttle cable [[↩ 6.5.A](#)]

### Carburation problems

Carburettor dirty

If the jet and pipes inside the carburettor clog up, the petrol supply drops and the engine becomes less efficient.

Check and clean the carburettor [[↩ 6.4.A](#)]

The governor malfunctions or there is a problem with the tie rods

The pneumatic governor fin disc is broken or does not move freely and therefore fails to work the carburettor correctly.

Check the entire governor system [[↩ 6.5](#)]

➤ **SV150:** The bent or warped governor rods are bent, deformed or do not move freely, preventing the governor from reaching its end-of-stroke.

➤ **M150:** The regulator lever transfers the motion of the internal counterweight device to the carburettor control tie-rod system; if the lever is not correctly in phase with the pin, it will not act properly on the tie-rod system.

|  |  |  |                                |
|--|--|--|--------------------------------|
| <br> | <b>5.1.1</b><br><b>TROUBLESHOOTING</b> | <br> | from 2007 to<br>page ◀ 4 / 5 ▶ |
|--|--|--|--------------------------------|

Insufficient pressure

The piston rings can wear out due to the passage of dust or overheating caused by the lack of oil.

Replace the engine  
[\[↩ 6.9.C\]](#)

The cylinder head screws can loosen causing the gasket to burn.

Dismount the cylinder head and replace the gasket [\[↩ 6.9.A\]](#)

### Environmental problems

The engine is used at a high altitude

The rarefaction of air in the mountains causes a drop in power of approx. 10-12% every 1000 metres of altitude.

Advise your client to adapt the strain of the lawnmower to the limited power available.

## F) The engine runs irregularly

| Probable cause | Comment | Solution |
|----------------|---------|----------|
|----------------|---------|----------|

### Carburation problems

Air seeps into the carburettor

If air seeps through the gaskets, it can cause the lawnmower to function poorly and make it difficult to maintain the minimum speed (2200-2500 rpm).

Replace the carburettor gaskets [\[↩ 6.4.A\]](#)

The governor malfunctions or there is a problem with the rods

The pneumatic governor fin disc is broken or does not move freely and therefore fails to work the carburettor correctly.

Check the entire governor system [\[↩ 6.5\]](#)

The governor rods are bent, deformed or do not move freely, preventing the governor from reaching its end-of-stroke.

### Starting problems

The coil air gap has been poorly adjusted

The air gap adjustment between the flywheel and coil must be 0.25-0.40 mm.

Adjust the air gap [\[↩ 6.6.B\]](#) and if the problem persists, replace the coil [\[↩ 6.6.C\]](#)

## G) The engine overrevved

| Probable cause | Comment | Solution |
|----------------|---------|----------|
|----------------|---------|----------|

### Carburation problems

Governor blocked

Excess dirt or a broken spring can impede the movements of the governor or impede return.

Check the governor [\[↩ 6.5.B\]](#)

|        |  |        |                              |
|--------|--|--------|------------------------------|
| ◀<br>◀ | <b>5.1.1</b><br><b>TROUBLESHOOTING</b> | ▶<br>▶ | from 2007 to<br>page ◀ 5 / 5 |
|--------|--|--------|------------------------------|

| <b>H) The engine does not turn off</b> |         |          |
|--|---------|----------|
| Probable cause                         | Comment | Solution |

### Lawnmower problems

|  |   |   |
|--|---|---|
| The engine brake cable is bent or jammed | When the lever is released, the earth microswitch is not pressed. | Check and/or adjust the cable [ <a href="#">↔ 6.7.A</a> ] |
|--|---|---|

### Electrical problems

|   |  |  |
|---|--|--|
| The earth cable is disconnected or broken | The broken or disconnected cable prevents the microswitch from closing the electric circuit to earth | Check the earth connection [ <a href="#">↔ 6.7.B</a> ] |
|---|--|--|

| <b>J) The engine judders</b> |         |          |
|------------------------------|---------|----------|
| Probable cause               | Comment | Solution |

### Lawnmower problems

|                    |   |   |
|--------------------|---|---|
| Blade not balanced | The imbalanced or loose blade causes judders and the premature wear of all the parts inside the engine. | Dismount and balance the blade and tighten the screws to the specified levels |
|--------------------|---|---|

|                     |   |  |
|---------------------|---|--|
| Engine screws loose | An engine with loose screws can be hazardous for the user and can break internal parts. | Tighten the screws to the specified levels [ <a href="#">↔ 6.9.C</a> ] |
|---------------------|---|--|

| <b>K) The engine does not stop within 3 seconds after it has turned off</b> |         |          |
|---|---------|----------|
| Probable cause  | Comment | Solution |

### Problems with the stopping system

|                            |   |  |
|----------------------------|---|--|
| Faulty or no clutch lining | The thickness of the clutch lining normally guarantees good braking action for the entire duration of the engine. | Replace the engine stopping system [ <a href="#">↔ 6.7.D</a> ] |
|----------------------------|---|--|

If it comes away from the lever, act immediately to stop the metal from rubbing against the fly-wheel causing hazardous sparks.

|                   |   |                   |   |
|-------------------|---|-------------------|---|
| <p>◀</p> <p>◀</p> | <p><b>6.1.1</b></p> <p><b>TANK AND SUPPLY</b></p> | <p>▶</p> <p>▶</p> | <p>from 2007 to</p> <hr/> <p>page 1 / 3 ▶</p> |
|-------------------|---|-------------------|---|

## 6.1 TANK AND SUPPLY

### GENERAL INFORMATION

The supply system consists of a petrol tank connected to the carburettor by a pipe. A mesh filter on the bottom of the tank stops deposits and impurities from reaching the carburettor.

The supply to the carburettor float chamber is caused by gravity and the volume of petrol taken from the tank as the engine runs is compensated by a breather pipe in the cap.

The supply system can malfunction in the following ways:

- difficult or failed start or insufficient power (if not due to other causes):
  - = Petrol filter dirty [↔ 6.1.B];
  - = Petrol pipes clogged;
  - = Inefficient breather pipe [↔ 6.1.C].

---

### SERVICING PROCEDURES

---



**WARNING!** All work on the tank and on the supply system must be carried out in safe conditions, so:

- do not smoke;
- always empty the tank;
- work in a ventilated environment away from naked flames or unprotected sources of heat;
- collect petrol in a suitable container with a cap using a funnel and avoid spilling it on the work bench;
- remove all traces of spilt petrol immediately;
- check you have connected the pipes before pouring petrol back into the tank

#### A) Emptying and removing the tank

- 1 Remove the conveyor [↔ 6.2A].
- 2 Remove the ring (3) of the petrol pipe (4) from the carburettor side and drain all the fuel from the tank into a suitable container.
- 3 Remove the baffle (5) of the conveyor.

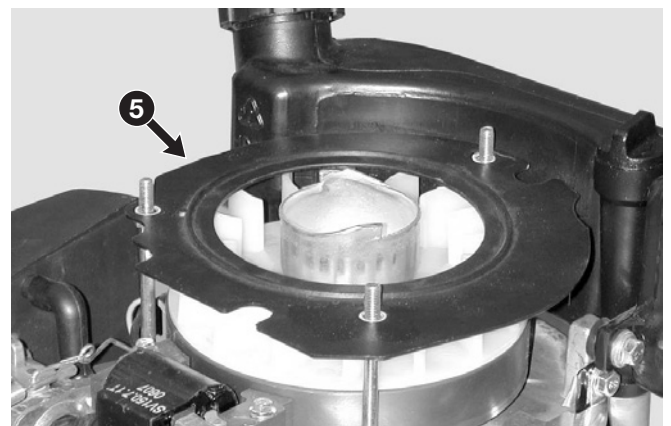
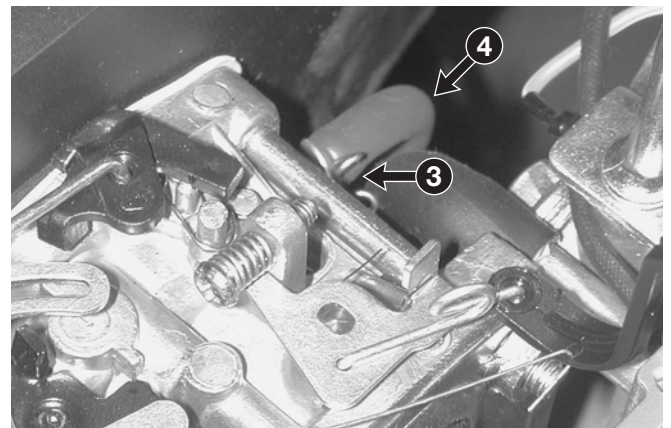
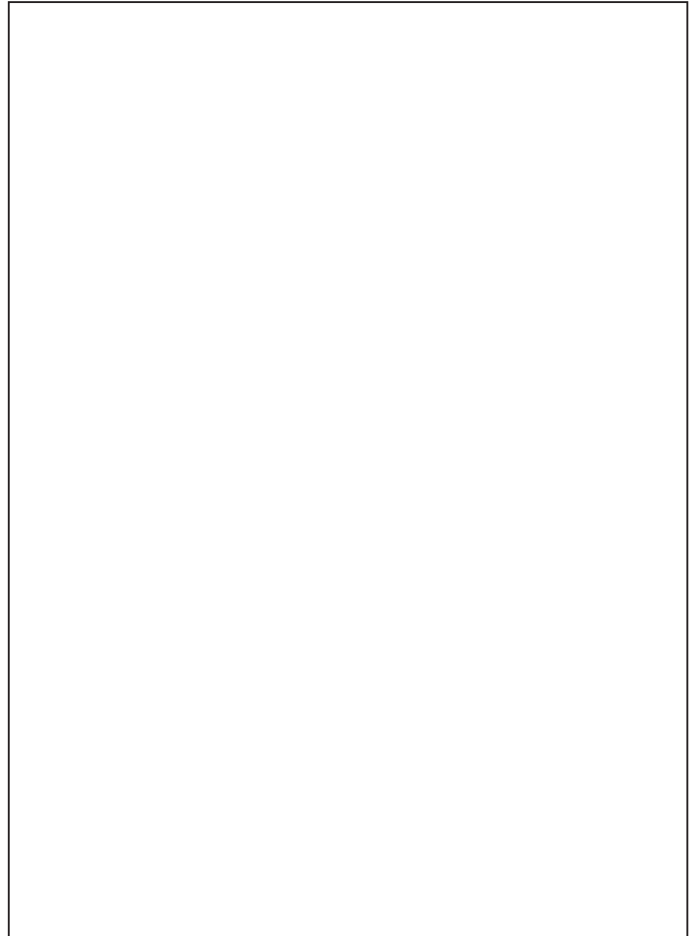



|   |                                       |
|---|---------------------------------------|
| <p>6.1.1<br/><b>TANK AND SUPPLY</b></p> | <p>from 2007 to</p> <p>page 2 / 3</p> |
|---|---------------------------------------|

- 4 The tank (6) is fixed by three screws (7).
- 5 For assembly, follow the above procedures in reverse order.
- 6 Remount the conveyor [↪ 6.2A].



**WARNING!** Check that the petrol pipe (4) is intact and secured correctly before pouring in new fuel.

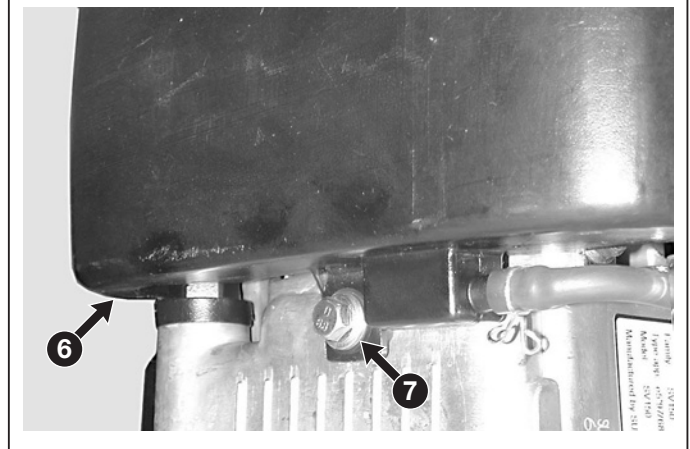

### B) Cleaning the tank

- 11 Remove the conveyor [↪ 6.2A].
- 12 Remove the clip (8) from the side of the tank and disconnect the petrol pipe (4).
- 13 Pull out the stalk of the filter (9) and blow compressed air so as to remove the deposits present inside.
- 14 Keep the tube hole (10) closed, pour in approx. 100 cl of clean petrol and shake well to clean inside the tank.
- 15 Empty the tank and dispose of the petrol used for cleaning in accordance with the laws in force.
- 16 Remount the tank [↪ 6.1.A].
- 17 Remount the conveyor [↪ 6.2A].

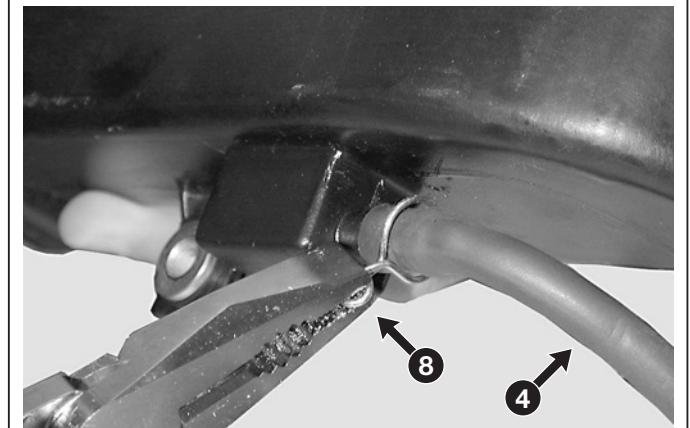

**WARNING!** Check that the petrol pipe (4) is intact and secured correctly before pouring in new fuel.

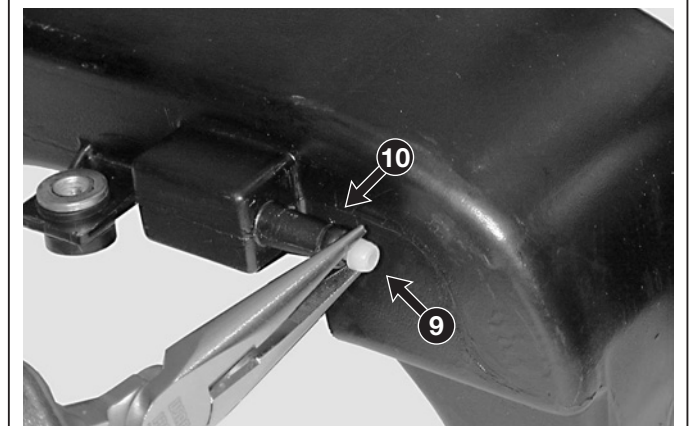





## 6.1.1 TANK AND SUPPLY



from 2007 to  
page 3 / 3

### C) Checking and cleaning the breather pipe

- 21 Remove the cap (11) and pull out the gasket (12) and the sponge (13).
- 22 Check that:
- the gasket (12) is intact and without cracks or fissures;
  - the air passages (14) inside the cap are not clogged;
  - the sponge (13) is not crushed or broken.

**NOTE**

Always replace the entire cap if the gasket or sponge is damaged.

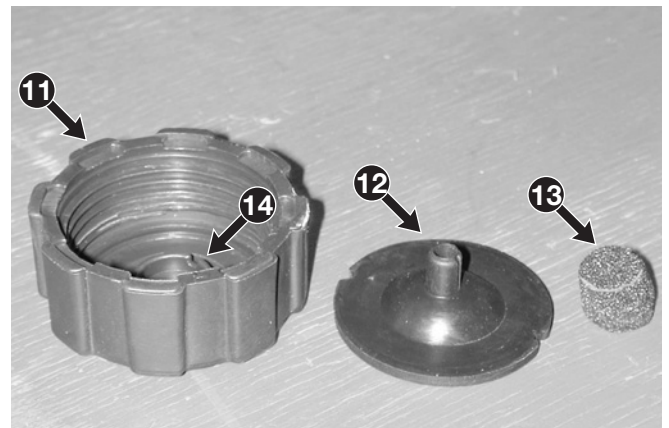
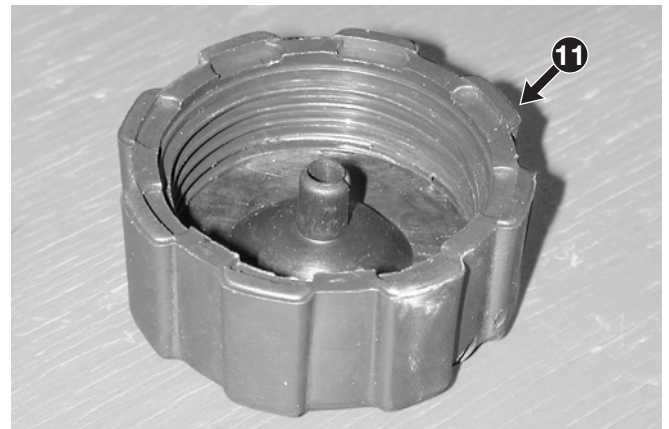
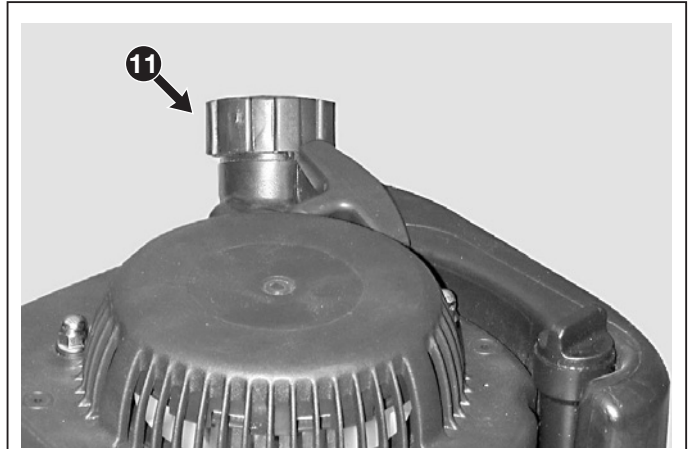

**Tightening torques**

7 Tank fastening screws ..... 4-7 Nm

|   |                                    |
|---|------------------------------------|
| <p>6.2.1<br/><b>STARTING SYSTEM</b></p> | <p>from 2007 to<br/>page 1 / 2</p> |
|---|------------------------------------|

## 6.2 STARTING SYSTEM

### GENERAL INFORMATION

The starting system is built into the upper conveyor and consists of a cable wound onto a pulley. The movement from the pulley to the flywheel (and the engine shaft) is transmitted by a pair of hooks. The cable is returned and rewound by a spiral spring.

Other than the possibility of the cable breaking, the starting system may malfunction in the following ways:

- failed start after attachment (if not due to other causes):  
= cable too short, therefore does not supply adequate number of revs to the engine [↖ 6.2.B].
- the pulley is not attached to the flywheel. This can be detected when the cable unwinds without strain :  
= the hooks are deformed or broken [↖ 6.2.C].
- inefficient or no return of the cable:  
= spring broken

In all cases, remove the conveyor to make the necessary checks or repairs.

### SERVICING PROCEDURES

#### A) Removing the conveyor

- 1 The conveyor (1) can be accessed after removing the possible outside cowls and it is fixed by three nuts (2).

#### B) Replacing the cable

- 11 Remove the conveyor with the tank [↖ 6.2.A].
- 12 Keep hold of the pulley (3) and slowly unwind (clockwise) the entire cable (4) to gradually release the return spring. If the cable breaks, the spring will be already released and you will only have to unwind the cable.
- 13 Undo or cut the knot at the end of the cable or remove the section still attached to the pulley.
- 14 Cut a section of cable (4) (Ø 4.5 mm and 2.40 m

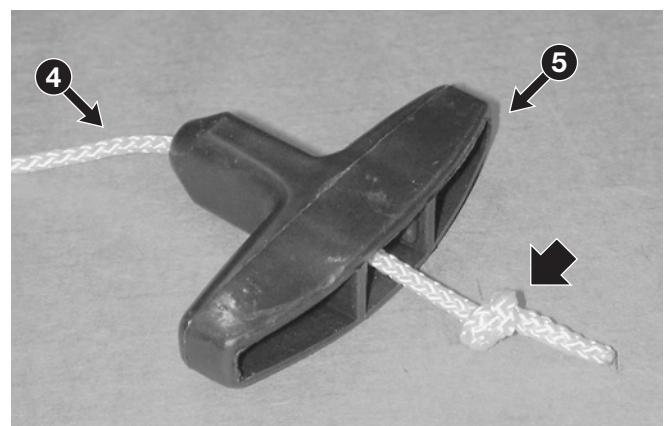
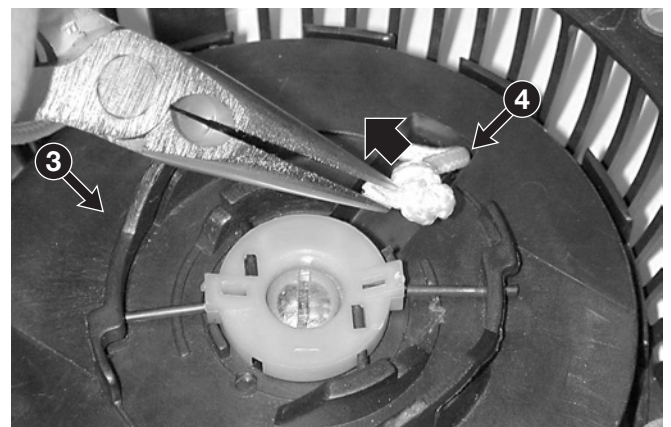
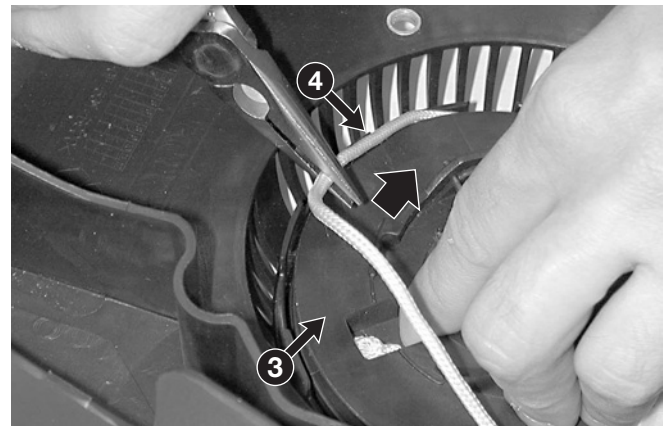
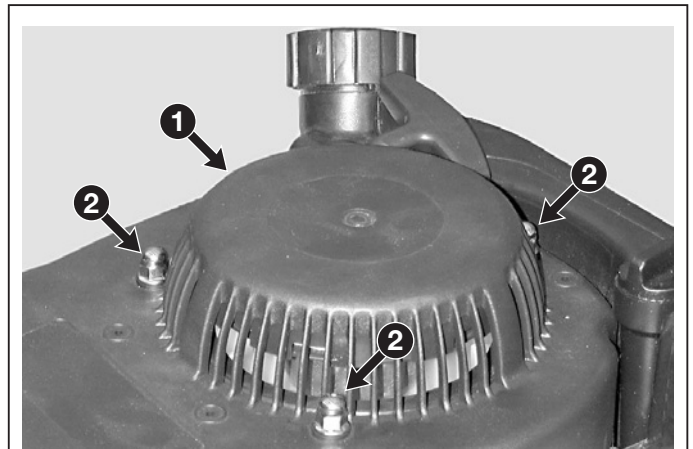



## 6.2.1 STARTING SYSTEM

from 2007 to  
page 2 / 2

long), fit one end in the pulley hole (3) and make a knot to prevent it from slipping out.

- 15 Fit the other end of the cable in the conveyor hole, securing it to the handle (5) with a knot.
- 16 Turn the pulley (3) and the cable (4) anticlockwise for approx. 8 complete revs to load the spring, then release the pulley carefully to wind the entire cable onto the pulley.
- 17 Check that the pulley (3) is free to rotate.
- 18 After pulling the entire length of the cable, check that the pulley (3) is able to complete 2-3 turns before compressing the spring.
- 19 Remount the conveyor [↪ [6.2.A](#)].

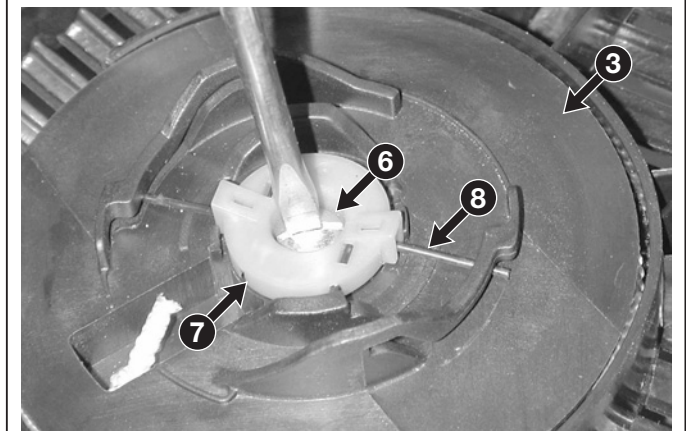
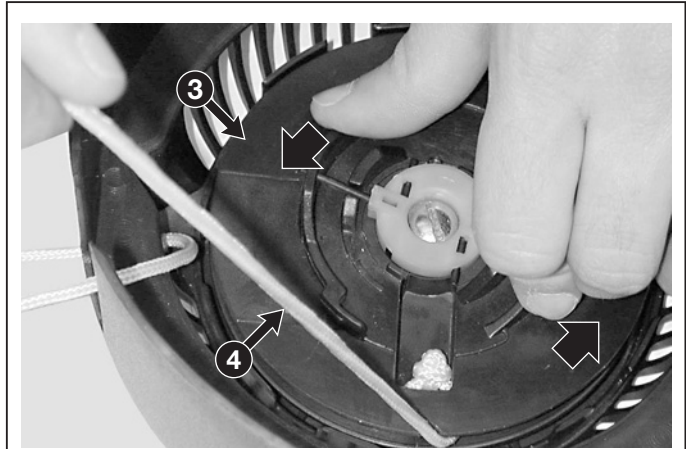

### C) Replacing the hooks

- 21 Remove the conveyor [↪ [6.2.A](#)].
- 22 Loosen the central screw (6) and dismount the bushing (7) and hooks (8) without letting the pulley (3) slip out of place.

**NOTE**  
The screw (6) has a left-handed thread and therefore should be **unscrewed clockwise**.

**NOTE**  
Always replace the hooks (8), the bushing (7) and the screw (6) in one block.

- 23 Mount the new hooks (8), taking care to position them correctly with the bushing (7) and the guides in the pulley hub (3). Tighten the screw (6) **anticlockwise** so that the pulley rotates smoothly.
- 24 Remount the conveyor [↪ [6.2.A](#)].

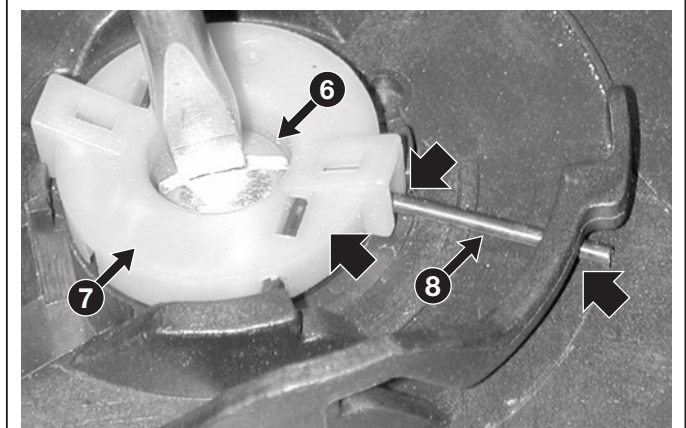
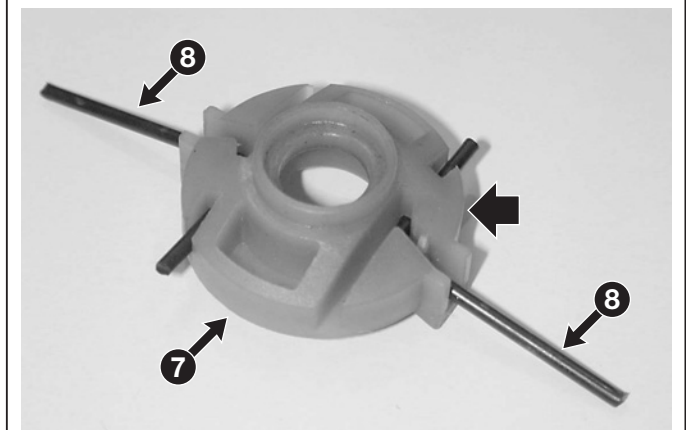

### Tightening torques

|   |                               |        |
|---|-------------------------------|--------|
| 2 | Conveyor fastening nuts ..... | 4-7 Nm |
| 6 | Starter screw .....           | 4-6 Nm |



|                                       |                                    |
|---------------------------------------|------------------------------------|
| <p>6.3.1<br/><b>INTAKE SYSTEM</b></p> | <p>from 2007 to<br/>page 1 / 2</p> |
|---------------------------------------|------------------------------------|

## 6.3 INTAKE SYSTEM

### GENERAL INFORMATION

The intake system uses an air filter which is directly connected to the carburettor and a manifold which conveys the air/petrol mixture towards the induction valve.

The intake system can malfunction in the following ways:

- no or difficult starting or insufficient power (if not due to other causes);  
= Air filter clogged [[↗ 6.3.A](#)];

The air filter is found on the right hand side of the engine and can be inspected without having to remove other parts.  
The entire body of the filter only needs to be removed in case of access to the carburettor.

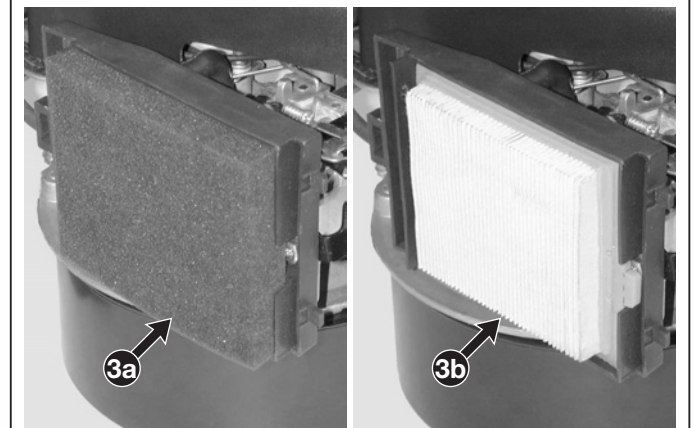

### SERVICING PROCEDURES

#### A) Maintenance of filtering element

- 1 Clean the area around the filter cover (1).
- 2 Remove the cover (1) by releasing the rear tab (2) and remove the filtering element (3a or 3b).

#### ➤ SV150 - Sponge filtering element:

**IMPORTANT!** The filtering element must be kept clean and soaked in oil. Replace it if broken, cracked or fragmented. Do not use compressed air for cleaning the filtering element.

- 3 Wash the sponge filtering element in water and detergent and dry it with a clean cloth.
- 4 Soak the filtering element with 2 spoonfuls of clean engine oil and squeeze it several times to spread the oil evenly (4).
- 5 Remove any excess oil with a clean cloth.

#### ➤ M150 - Cartridge filtering element:

**IMPORTANT!** Do not use water, petrol, deter-

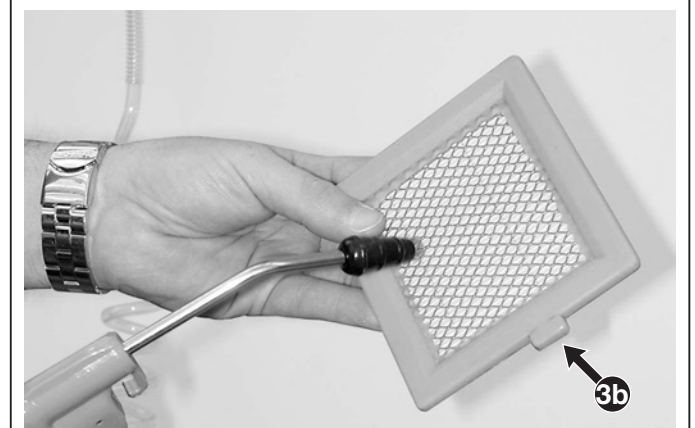
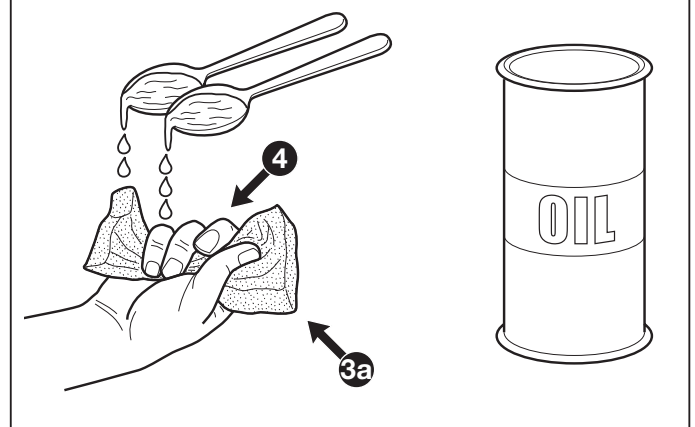



## 6.3.1 INTAKE SYSTEM



from 2007 to  
page 2 / 2

gents or any other products to clean the filtering element.

6 Blow compressed air from the inside to remove dust and grass cuttings.

7 With a jet of compressed air, clean inside the body (5) of the filter by removing dust and remains of grass, making sure that the intake pipe hole (6) is closed so that nothing gets inside the pipe.

8 Install the filtering element (3) in place and close the cover (1).

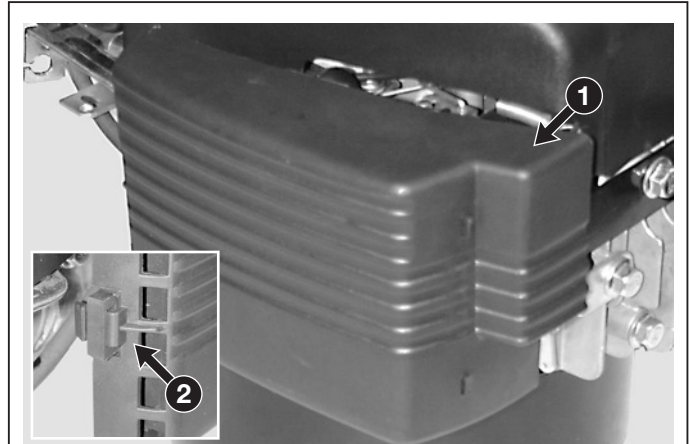

### B) Removing the filter body

11 Clean the area around the filter cover (1).

12 Remove the cover (1) by releasing the rear tab (2) and remove the filtering element (3a or 3b).

13 To remove the filter body (5), loosen the screw (7) fastening the governor system bracket and the two screws (8), remembering that both these screws also fasten the carburettor to the engine block.

14 Disconnect the oil vapour circulation pipe (9).

15 When mounting, make sure the gasket is positioned correctly (10) and remember to connect the oil vapour recycling tube (9).

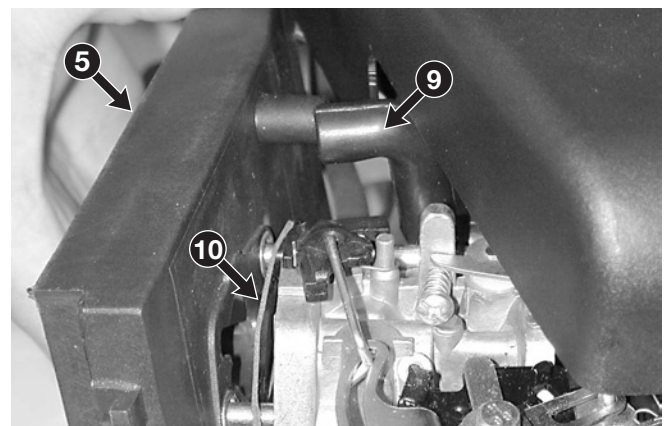
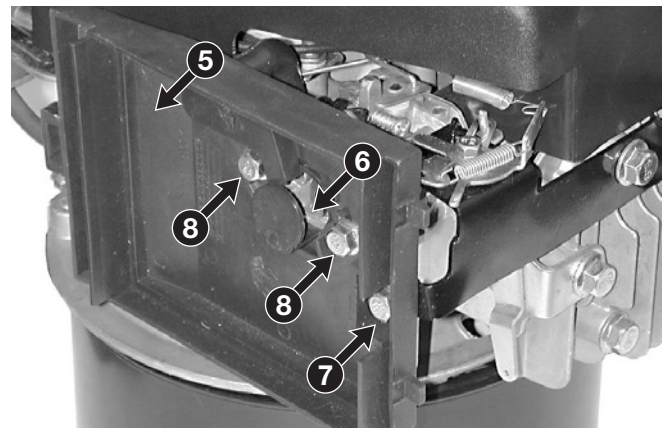
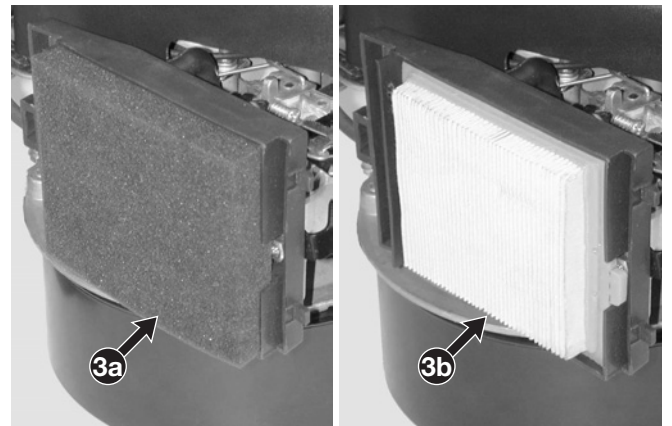

### Tightening torques

|   |                              |        |
|---|------------------------------|--------|
| 7 | Governor bracket screw ..... | 6-8 Nm |
| 8 | Carburettor screw .....      | 6-8 Nm |

|                   |   |                   |   |
|-------------------|---|-------------------|---|
| <p>◀</p> <p>◀</p> | <p><b>6.4.1</b></p> <p><b>CARBURATION</b></p> | <p>▶</p> <p>▶</p> | <p>from 2007 to</p> <hr/> <p>page 1 / 3 ▶</p> |
|-------------------|---|-------------------|---|

## 6.4 CARBURATION

### GENERAL INFORMATION

The carburettor has a float with a fixed jet and a "CHOKE" control.

The carburettor can malfunction in the following ways:

- difficult or failed start or insufficient power (if not due to other causes):  
= Carburettor dirty [↔ 6.4.A].
- engine runs irregularly (if not due to other causes):  
= Air has seeped into the carburettor [↔ 6.4.A].

---

### SERVICING PROCEDURES

---



**WARNING!** All operations on the tank and supply system must be carried out in safe conditions, so:

- do not smoke;
- always empty the tank if petrol is not strictly necessary for the operation to be carried out;
- work in a ventilated environment away from naked flames or unprotected sources of heat;
- collect petrol in a suitable container with a cap using a funnel and avoid spilling it on the work bench;
- remove all traces of spilt petrol immediately;
- check you have connected the pipes before pouring petrol back into the tank.

#### A) Removing and cleaning the carburettor

- 1 Remove the air filter [↔ 6.3.B].
- 2 Disconnect the two tie rods (1) and (2) and take the carburettor (3) out of the intake manifold (4).
- 3 Loosen the central screw (5) fastening the float chamber (6) and carefully collect all the petrol left in the float chamber.

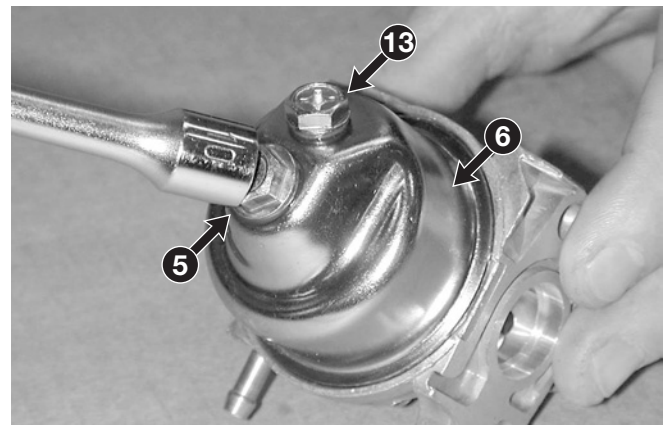
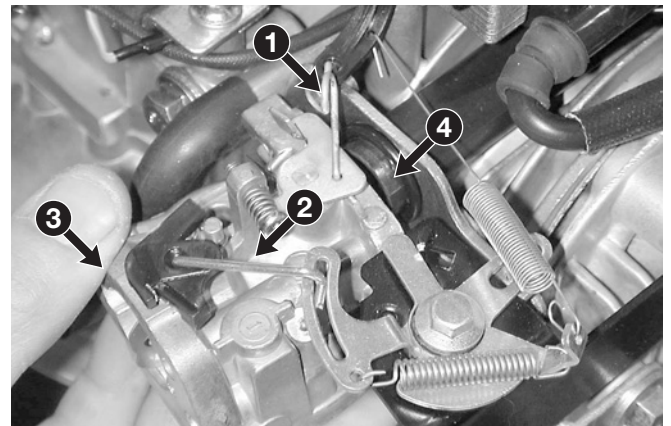
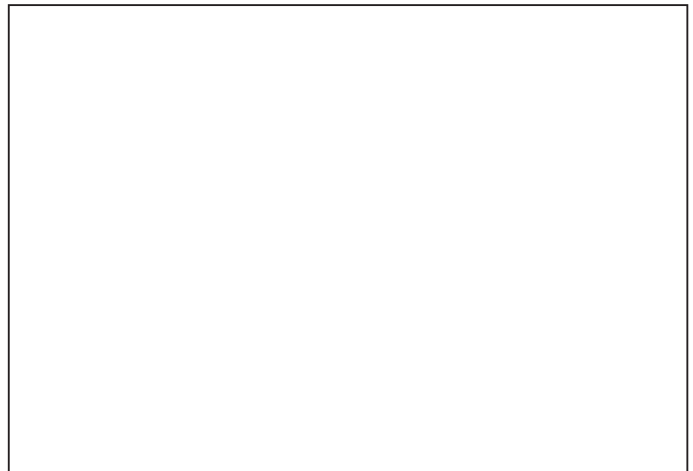



|                   |   |                   |   |
|-------------------|---|-------------------|---|
| <p>◀</p> <p>◀</p> | <p><b>6.4.1</b></p> <p><b>CARBURATION</b></p> | <p>▶</p> <p>▶</p> | <p>from 2007 to</p> <hr/> <p>page ◀ 2 / 3 ▶</p> |
|-------------------|---|-------------------|---|

- 4 Pull out the pin (7), dismount the float (8) and remove the gasket (9).
- 5 Undo the screw (10) and pull out the jet (11).
- 6 Clean the jet and the carburettor thoroughly by immersing them in clean petrol (or a detergent) for 24 hours. Dry with compressed air, blowing well through the carburettor holes.
- 7 Mount the carburettor following the previous points 5, 4 and 3 in reverse order, remembering that:
  - It is always advisable to replace the gasket (9) and the washer underneath the screw (5);
  - the float (8) must oscillate freely on the pin (7);
  - the jet (11) should never be modified or replaced with others even if they seem to have the same specifications;
  - the choke (12) must open and close regularly;
  - the float chamber drain screw (13) must be facing forwards.
- 8 When fitting the carburettor back on the engine, always replace the grommet (14) on the manifold side and the gasket (15) on the filter side.
- 9 Remount the tie rods (1) and (2) and check that the governor system moves smoothly without stopping.
- 10 Remount the air filter [➔ [6.3.B](#)].

## B) Replacing the carburettor

- Follow steps 1 - 2 - 8 - 9 - 10 - of the procedure described in point “A”.

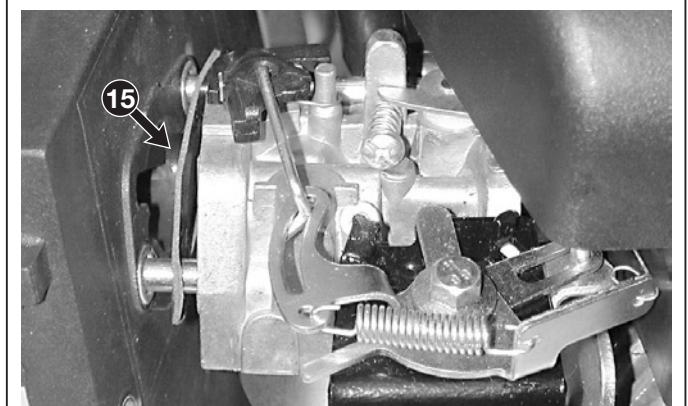
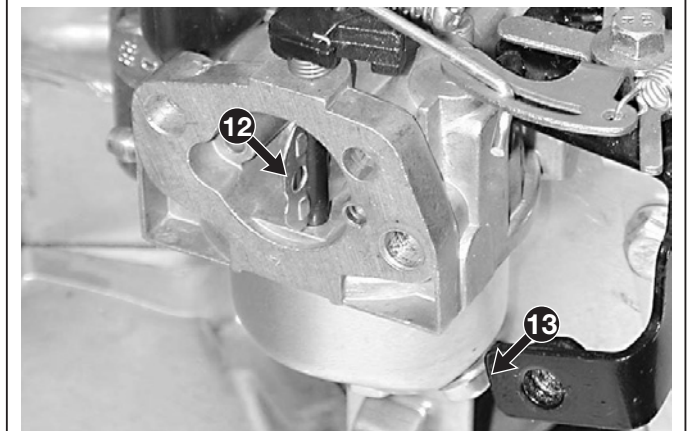
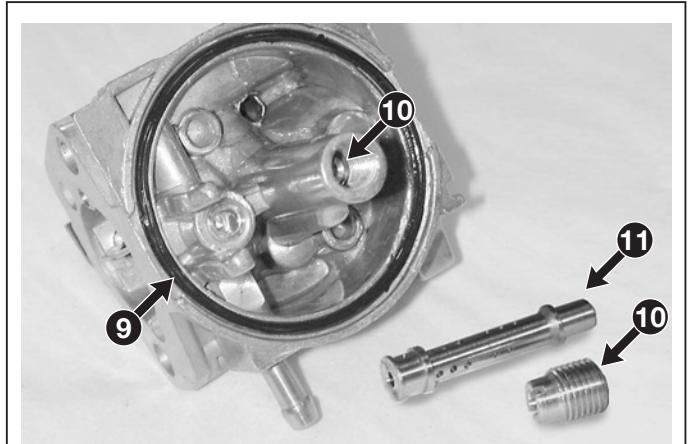





## 6.4.1 CARBURATION

from 2007 to  
page 3 / 3

### C) Adjusting minimum speed

- 21 Check that the throttle cable is adjusted correctly [[↔ 6.5.A](#)].
- 22 Let the engine heat up for a few minutes, then set the throttle control to "SLOW". Check the rotation speed on the speed indicator (21).

**NOTE**

The engine's minimum speed must be between 2200 and 2500 rpm.

- 23 Turn the screw (22) on the carburettor until you achieve a stable minimum speed within the above values.

### D) Adjusting maximum speed

**NOTE**

This operation is carried out by adjusting the governor system [[↔ 6.5.B](#)].

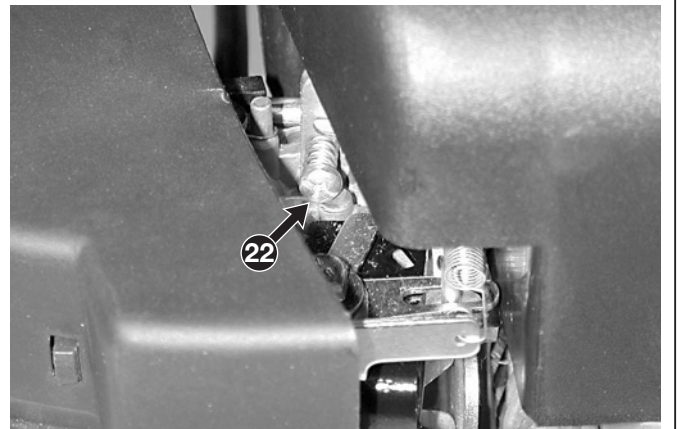
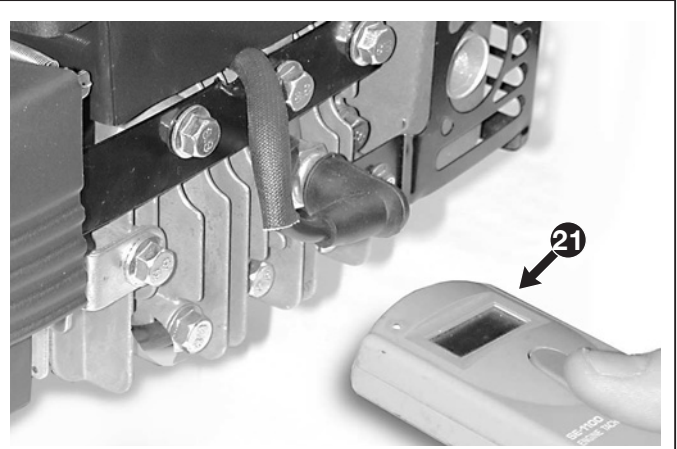

---

**Technical information**

---

Minimum speed (SLOW) ..... 2200-2500 rpm

---

**Special equipment**

---

- 21 Speed indicator
-

|   |              |
|---|--------------|
| 6.5.1                                     | from 2007 to |
| <b>GOVERNOR SYSTEM OF THE CARBURETTOR</b> | page 1 / 4   |

## 6.5 GOVERNOR SYSTEM OF THE CARBURETTOR

### GENERAL INFORMATION

The carburettor adjustment system makes use of a linkage fitted to a support fixed to the engine's head, integrated with an adjustment device, which can be:

- **pneumatic, for SV150.** This device consists of a fin disc which tends to close the carburettor's choke under the pressure of the flywheel air, against the main spring of the control lever. The balance between the throttle control and the push of air on the fin disc adapts the flow of mixture into the engine depending on the power required.
- **with counterweights, for M150.** The adjustment system consists of a counterweight device whose thrust, transferred to the control lever, tends to close the carburettor's main butterfly, in opposition to the spring that would keep it open; the balance between the load of the spring and the thrust of the counterweights on the control lever modifies the butterfly opening and adapts the flow of fuel to the engine so as to keep the rotation speed constant while varying the load on the engine.

The governor system can malfunction in the following ways:

- difficult or failed start or insufficient power (if not due to other causes):
  - = Incorrect adjustment of the throttle cable [↔ 6.5.A];
  - = rods bent or deformed [↔ 6.5.B];
  - = breakage or blocking of the adjustment device [↔ 6.5.B].
- Engine runs irregularly (if not due to other causes):
  - = breakage or blocking of the adjustment device [↔ 6.5.B].
- Engine that exceeds peak r.p.m. (over-revving) (if not due to other causes):
  - = breakage or blocking of the adjustment device [↔ 6.5.B].

### SERVICING PROCEDURES

#### A) Adjusting the throttle cable

- 1 Loosen the screw (1) of the clamp (2) so that the cable sheath (3) runs freely.

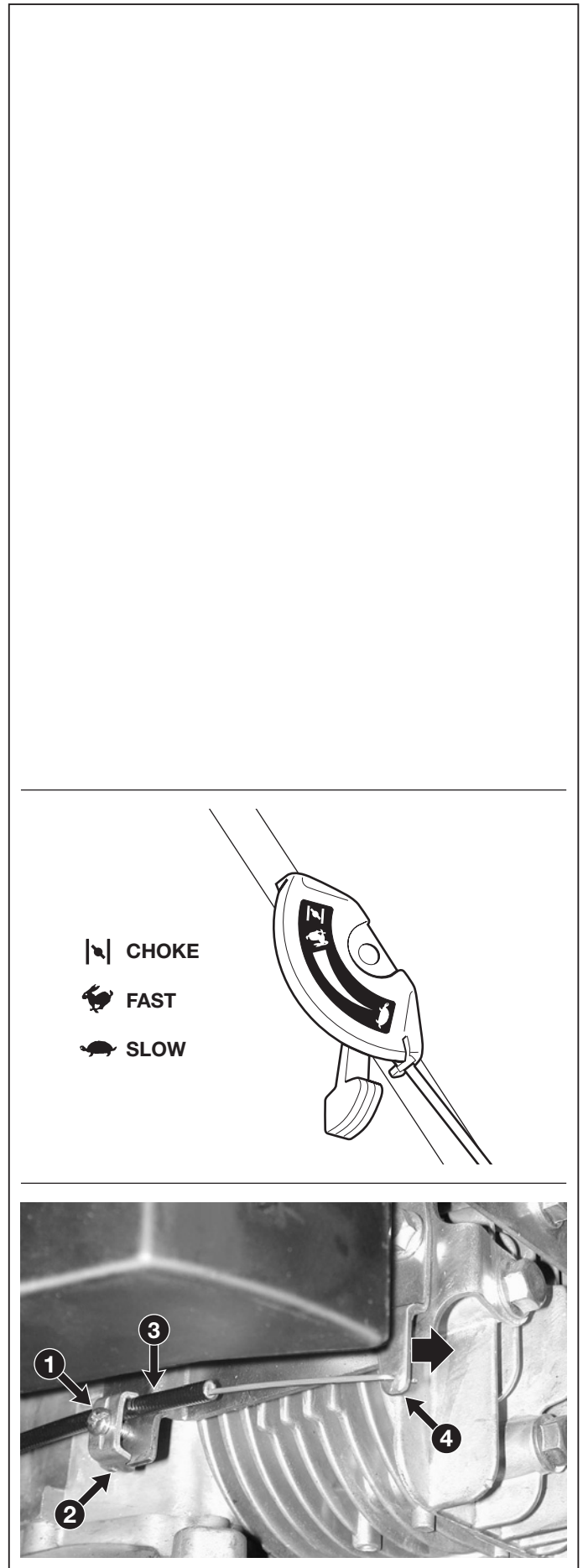

|   |   |
|---|---|
| <p>6.5.1</p> <p><b>GOVERNOR SYSTEM OF THE CARBURETTOR</b></p> | <p>from 2007 to</p> <p>page ◀ 2 / 4 ▶</p> |
|---|---|

- 2 Set the throttle control lever to "SLOW".
- 3 Push the speed governor lever forward as far as reaching the end of stroke (4), keep it in this position and secure the cable sheath (3) by tightening the screw (1) of the clamp (2).

**B) Adjusting maximum speed**

- 11 Check that the throttle cable is correctly adjusted [↖ point "A"].
- 12 Let the engine heat up for a few minutes then set the throttle control to "FAST". Check the rotation speed on the speed indicator (21).

**NOTE**

The engine's maximum speed must be between 2800 and 3000 rpm; if you do not read this value, proceed as follows.

- 13 Check:
  - that the spring (22) is intact and that the spring hook wire (23) is not bent and replace them if necessary;
  - that the levers are not bent or deformed and replace the entire support if necessary [↖ point "C"];

➤ **SV150 - SV150 – With pneumatic regulator:**

- 14 Check that the fin (24) of the pneumatic device is not broken and that it can move freely. If the fin is broken, even partly, it must be replaced [↖ point "D"];
- 15 If the above checks do not reveal faults, a difference between the measured speed and specified speed can be compensated by bending the spring hook clip (25):
  - inwards to reduce the rpm;
  - outwards to increase the rpm.
- 16 If you fail to reach the specified values, adjust the position of the fin disc (24) in relation to the flywheel by tightening or loosening the central ring on the tie rod (26) to increase or decrease the centre distance between the terminals.

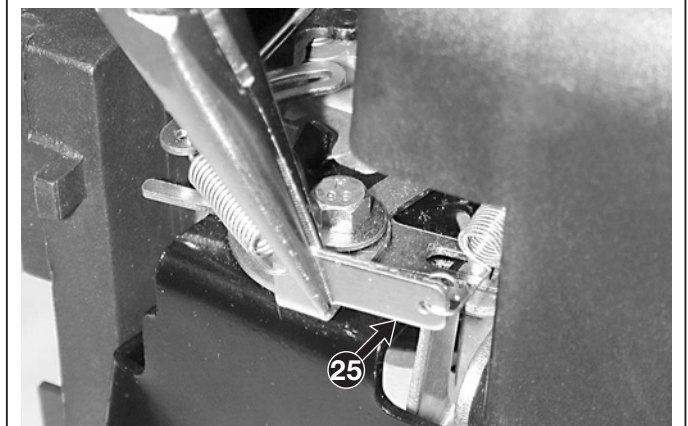
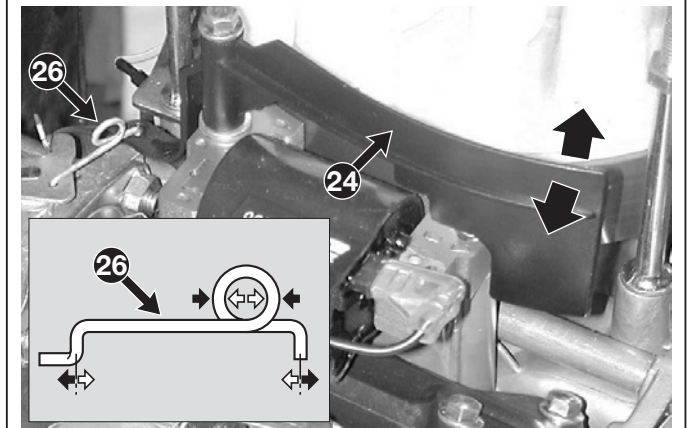
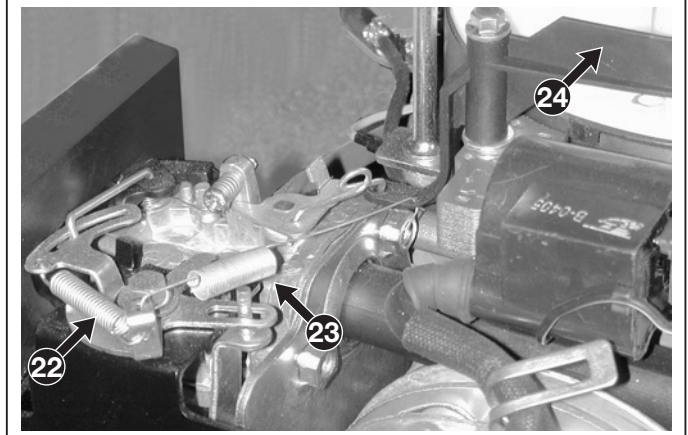



|   |                |
|---|----------------|
| 6.5.1                                     | from 2007 to   |
| <b>GOVERNOR SYSTEM OF THE CARBURETTOR</b> | page ◀ 3 / 4 ▶ |

➤ **M150 - With counterweight regulator:**

17 Should the aforementioned checks not reveal any faults, the phasing of the control lever (27) with respect to the counterweight device must be checked:

- stop the engine and set the throttle control to "FAST";
- loosen the fastening nut (28) of the control lever (27);
- without changing the position of the lever (27), rotate the pin (29) in a clockwise direction to end of stroke, and then lock the nut (28).

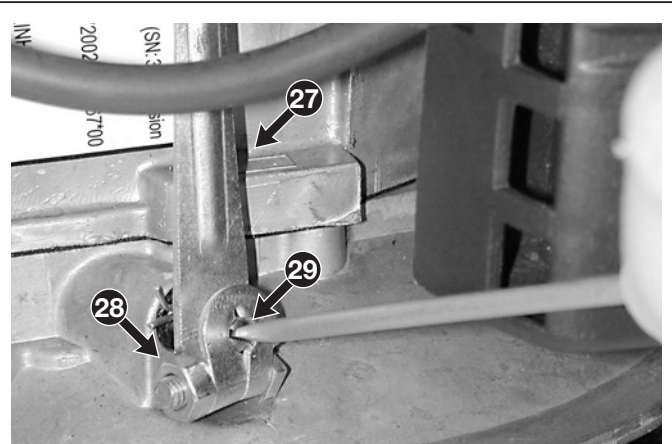

**C) Replacing the lever system support**

21 Remove the conveyor [➔ 6.2.A].

22 Remove the air filter cover (31) and the filtering element (32), then loosen the screw (33).

23 Unscrew the three screws (34) which secure the support (35) to the cylinder head, then remove the support (35) releasing the spring (36) and the tie-rod (38).

24 When mounting, remember to tighten the screws (34) to the specified levels and avoid a drop in pressure with the risk of burning the cylinder head gasket. We therefore recommend checking the other five cylinder head screws too.

25 Remount the conveyor [➔ 6.1.A].

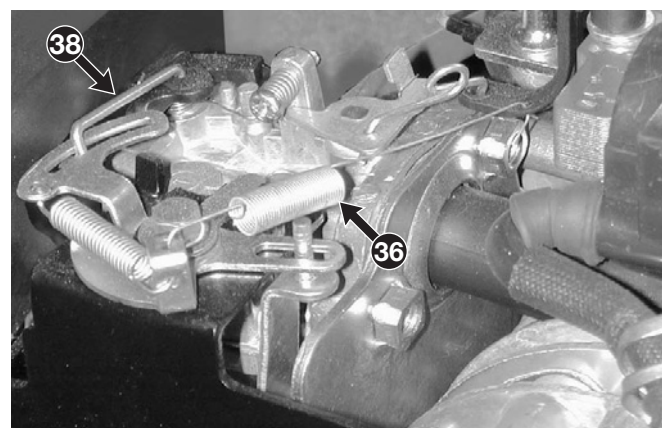
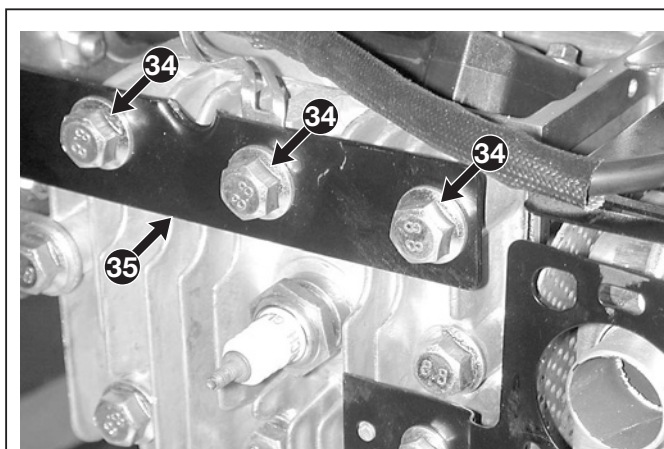
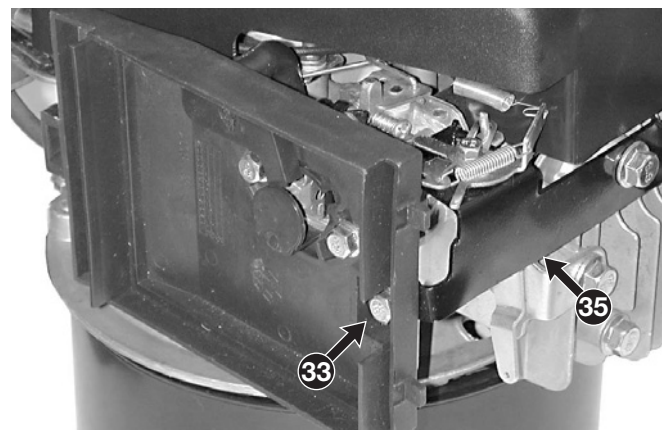
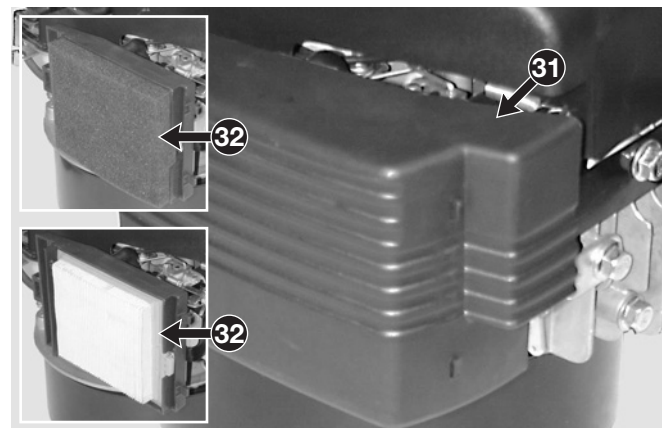

**D) Replacing the fin disc on the pneumatic device (Only SV50)**

- 31 Remove the conveyor [↪ 6.2.A].
- 32 Unhook the spring (36).
- 34 Dismount the fin disc (37) which is fastened by the screw pin (39) and disconnect the tie rod (40).
- 35 When mounting,
  - Make sure the washer (41) is correctly positioned underneath the fin disc (37) and securely tighten the pin (39) in such a way that the fin disc (37) moves freely;
  - Check that the tie rod (40) has a centre distance between the ends that brings the fin disc (37) to a distance of 13-15 mm from external surface of the flywheel (42). Otherwise tighten or loosen the central ring on the tie rod until you achieve the right distance. This tie rod adjustment should be considered "preliminary" and can be altered during maximum speed adjustment.
- 36 Remount the conveyor [↪ 6.2.A].
- 37 Adjust the maximum speed [↪ point "B"].

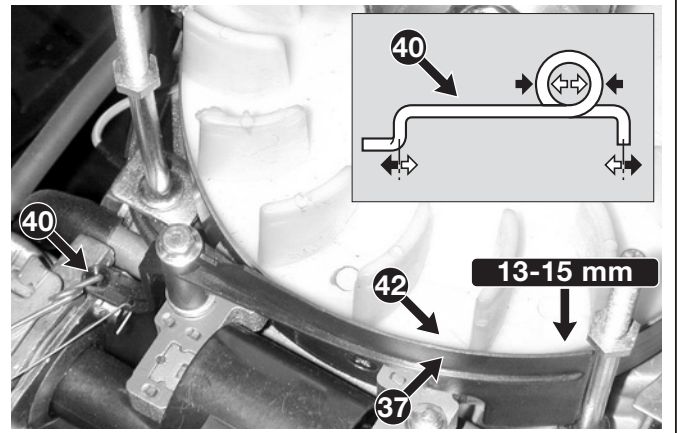
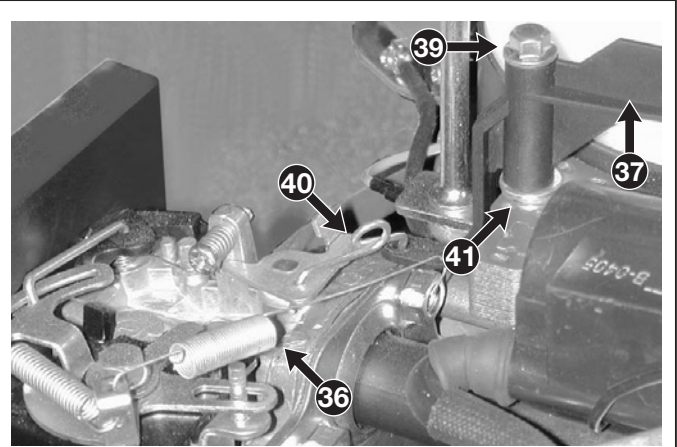

**Tightening torques**

34 Cylinder head screws ..... 20-25 Nm

**Technical information**

Maximum speed (FAST) ..... 2800-3000 rpm

**Special equipment**

21 Speed indicator

|   |                                    |
|---|------------------------------------|
| <p>6.6.1<br/><b>IGNITION SYSTEM</b></p> | <p>from 2007 to<br/>page 1 / 3</p> |
|---|------------------------------------|

## 6.6 IGNITION SYSTEM

### GENERAL INFORMATION

The ignition system has a flywheel with an electronic coil which supplies high voltage to the spark plug.

The starting system can malfunction in the following ways:

- the engine does not start (if not due to another cause):
  - = no spark on the spark plug due to a faulty coil [↔ 6.6.A];
  - = coil to earth [↔ 6.6.B and 6.7.B];
  - = incorrect adjustment of the air gap [↔ 6.6.B];
  - = faulty spark plug or wrong distance between the electrodes [↔ 6.6.A];
  - = oxidized or loose contacts [↔ 6.6.B].
- the engine runs irregularly (if not due to another cause):
  - = incorrect adjustment of the air gap [↔ 6.6.B];
  - = oxidized or loose contacts [↔ 6.6.B].

For access to the coil and the flywheel, remove the upper conveyor.

### SERVICING PROCEDURES

#### A) Checking the efficiency of the ignition system

1 Dismount the spark plug (1) and look at the colour on the end of the thread. This can give you a good idea of the carburation:

- black = mixture too greasy due to clogged air filter;
- nut brown = regular carburation.

Replace the spark plug if the electrodes (2) are burnt or if the porcelain is broken or cracked.



#### WARNING! Fire hazard:

- do not check the ignition system if the spark plug is not screwed in place;
- always use the specific tool for the spark test.

2 Connect the tester (3) to the spark plug cap (4)

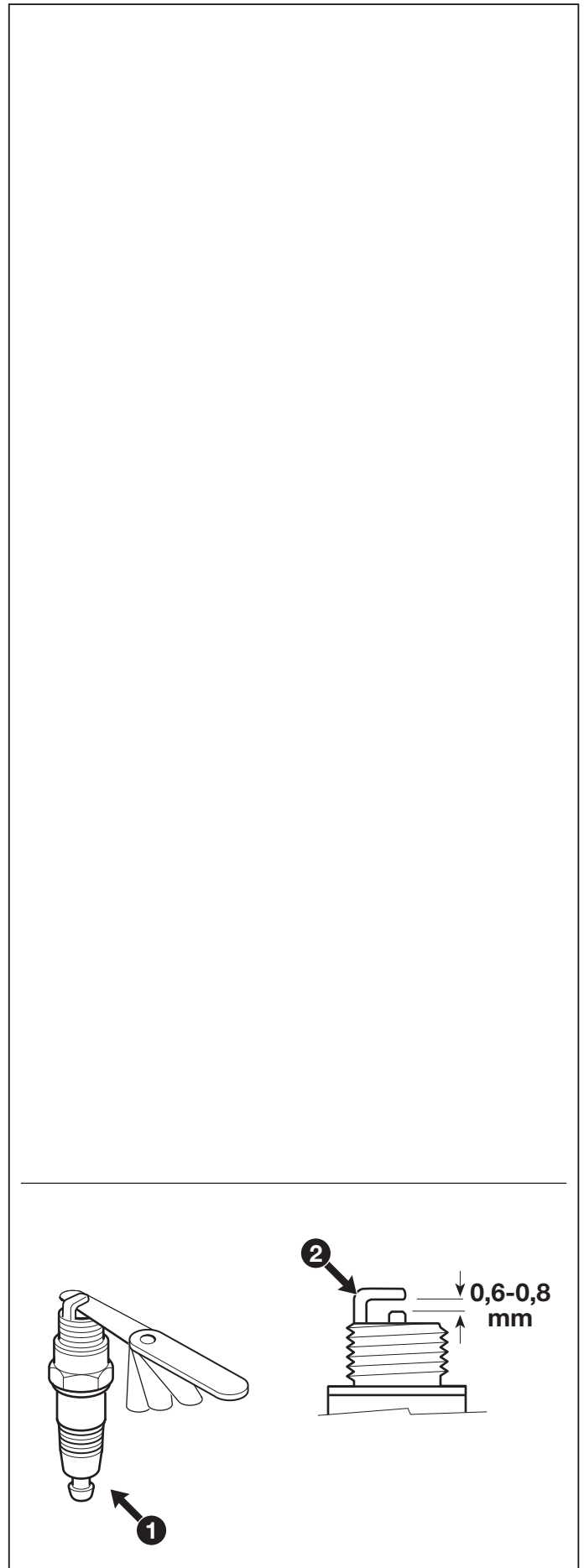





## 6.6.1 IGNITION SYSTEM



from 2007 to  
page 2 / 3

and to earth on the engine (5). Activate the starter and see in the instrument if the spark jumps.

- If the test has a positive result, clean the electrodes (2) with compressed air and adjust the distance to 0.6-0.8 mm. Remount the spark plug and tighten it to the specified levels.

Otherwise, check the system parts as described in point "B".

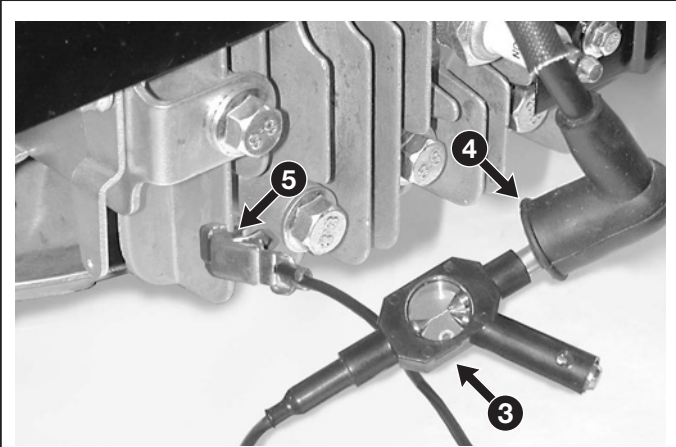

### B) Adjusting the air gap and checking the coil

- Remove the conveyor [→ 6.2.A]
- Make sure that the cable faston is not oxidized; if it is, disconnect, clean and remount it, spraying it with a special antioxidant.
- Check that the black earth cable (11) of the coil (12) is intact and that the insulation is not crushed due to incorrect assembly. The black spark plug cable should not have any cracks or signs of deterioration or burns which reduce its efficiency and insulation level.
- Loosen the two screws (13) securing the coil (12), release the brake manually and rotate the flywheel (14) until the magnetic inserts are lined up with the poles of the coil core (12).
- Insert a 0.35 mm thickness gauge (15) between the flywheel (14) and the coil poles. Push the coil until the poles come in contact with the thickness gauge and secure both screws (13). Tighten the screws remembering that the air gap must be between 0.25 and 0.40 mm.

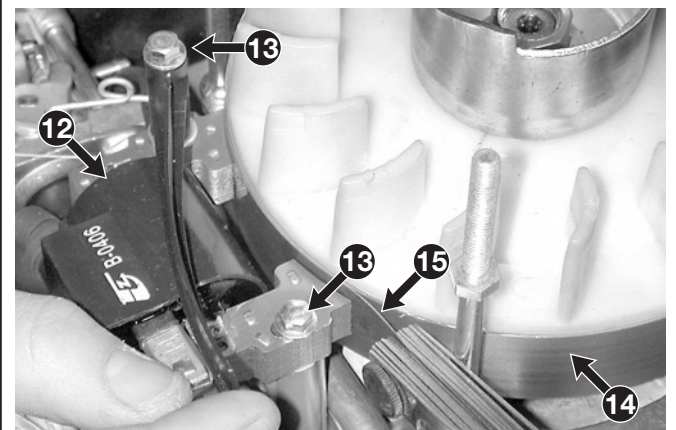
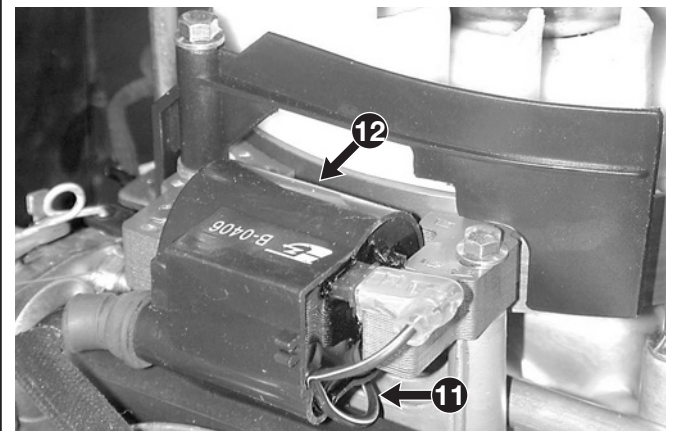

### NOTE

An accurate inspection of the efficiency of a coil can only be carried out in a laboratory equipped with an oscilloscope. To make a brief check, proceed as follows:

- Disconnect the faston of the black earth cable (11) and reposition the upper conveyor to activate the starter.

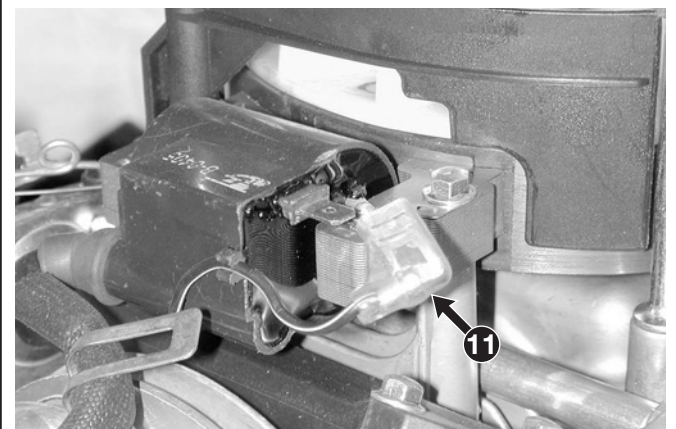



17 Carry out a spark test as described in point "A":

- If the spark jumps = the coil functions correctly, so if the system malfunctions, it is due to the earth microswitch or relative cable [[↔ 6.7.B](#)];
- If the spark does not jump = the coil is faulty and must be replaced [[↔ point "C"](#)].

18 Remount the conveyor [[↔ 6.2.A](#)].

### C) Replacing the coil

21 Remove the conveyor [[↔ 6.2.A](#)].

22 Disconnect the faston of the earth cable (11).

23 Undo the two screws (13) and take out the coil (12).

24 Mount the new coil without tightening the two screws (13) and turn the flywheel (14) until the magnetic inserts are lined up with the poles of the coil core (12).

25 Insert a 0.35 mm thickness gauge (15) between the flywheel (14) and the coil poles. Push the coil until the poles come in contact with the thickness gauge and secure both screws (13). Tighten the screws remembering that the air gap must be between 0.25 and 0.40 mm.

26 Connect the faston of the earth cable (11).

27 Remount the conveyor [[↔ 6.1.A](#)].

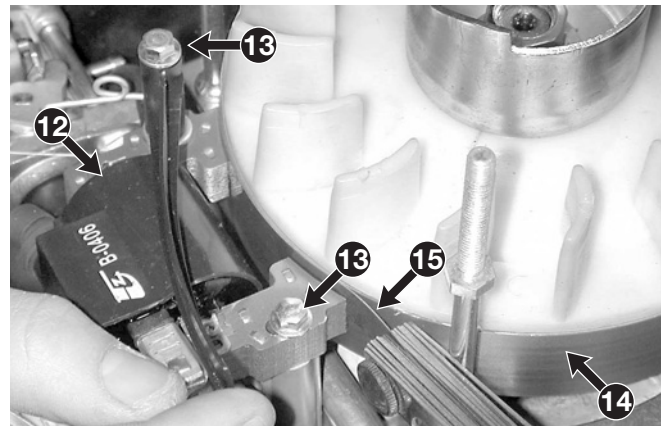

### Tightening torques

1 Spark plug tightening torque ..... 16-18 Nm

### Technical information

Type of spark plug ... RN9YC (Champion) or equivalent  
 Distance between electrodes ..... 0.6-0.8 mm  
 Coil/flywheel air gap ..... 0.25-0.40 mm

### Special equipment

3 Tester for spark test

|  |              |
|--|--------------|
| 6.7.1                                      | from 2007 to |
| <b>TURNING OFF AND STOPPING THE ENGINE</b> | page 1 / 3   |

## 6.7 TURNING OFF AND STOPPING THE ENGINE

### GENERAL INFORMATION

The engine is turned off and stopped by releasing a lever on the lawnmower. The cable acts on a lever which simultaneously activates a microswitch that sends the coil to earth as well as a brake which acts on the flywheel.

The brake must be able to stop the engine within 3 seconds after it is turned off.

The system for turning off and stopping the engine can malfunction in the following ways:

- the engine does not start:
  - = brake cable broken or disconnected [↔ 6.7.A];
  - = faulty switch [↔ 6.7.B];
  - = earth cable has deteriorated.
- the engine does not turn off:
  - = brake cable bent or jammed [↔ 6.7.A];
  - = faulty switch or disconnection [↔ 6.7.B].
- the engine does not stop within 3 seconds after it is turned off:
  - = clutch lining has come away [↔ 6.7.C].

If the microswitch malfunctions or if the brake lining has come away, replace the entire assembly which is mounted on a supporting bracket.

For access to the system for turning off and stopping the engine, remove the upper conveyor.

### SERVICING PROCEDURES

#### A) Checking the control cable

- 1 Check that the sheath (1) is not bent, that the wire (2) is securely connected to both the lawnmower lever and the **external hole** of the lever (3) on the engine and that the terminal (4) is correctly fastened to the support (5).
- 2 Check that the wire (2) runs freely inside the sheath (1) when you move the lever.
- 3 Check that the end of the wire (2) is slightly loose when you release the lawnmower lever.

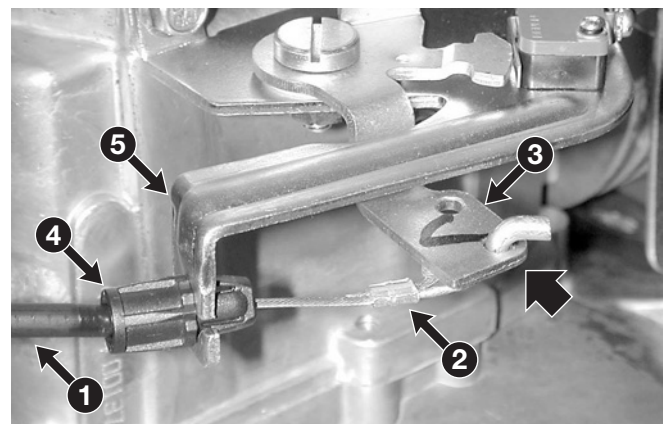
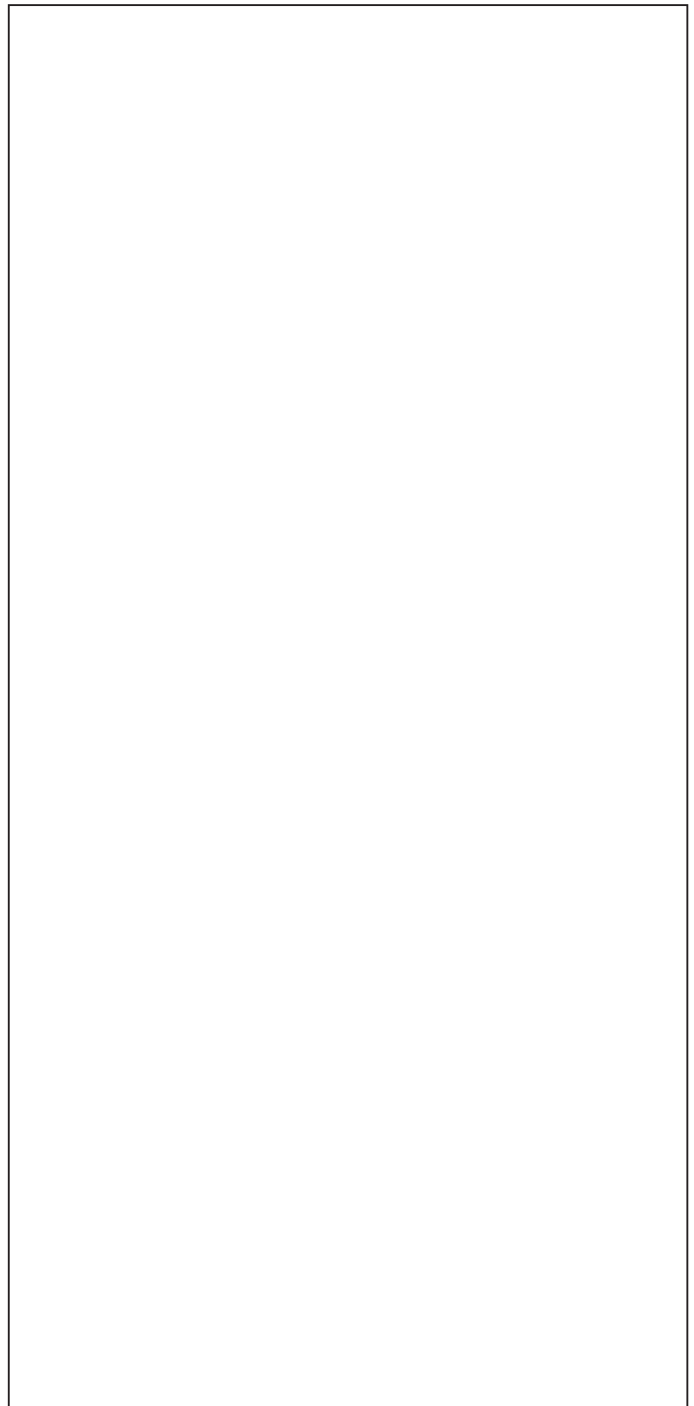

## B) Checking the ignition off microswitch

- 11 Remove the conveyor [↪ [6.2.A](#)].
- 12 Disconnect the faston (11) from the coil.
- 13 Using an Ohmmeter tester, make contact with the prods on terminals “1-COM” and “3-NO” of the microswitch (12); the instrument should read:
  - ∞ = microswitch pressed
  - 0 = microswitch free
- 14 Remount the conveyor [↪ [6.2.A](#)].

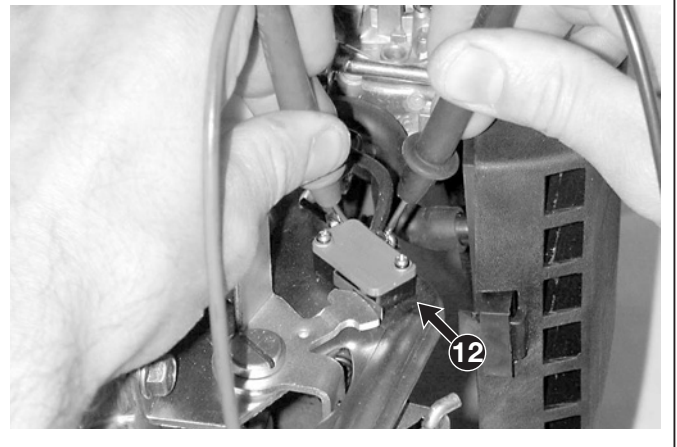
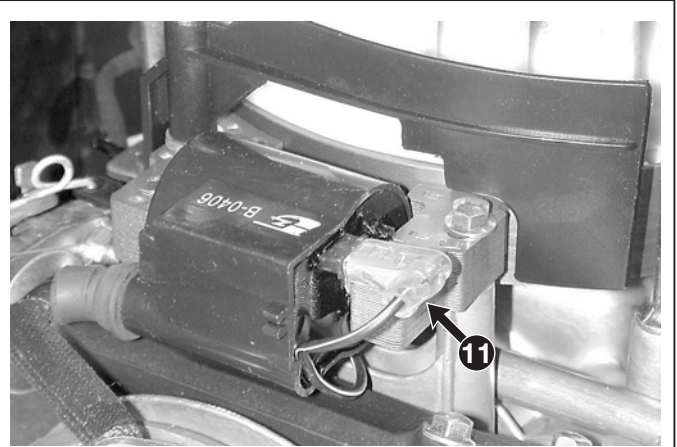

## C) Checking the brake

- 21 Remove the conveyor [↪ [6.2.A](#)].
- 22 Check that the clutch lining (13) is at least 2 mm thick at the thinnest point.
- 23 Make sure that the control lever (14) moves freely and remove any remains of grass and mud.
- 24 Reconnect the petrol pipe and start the engine. Release the lawnmower lever and check that the engine stops within 3 seconds.
- 25 If it stops after 3 seconds, replace the entire assembly [↪ [point “D”](#)], because the spring or clutch lining is unable to guarantee the right braking times.
- 26 Remount the conveyor [↪ [6.2.A](#)].

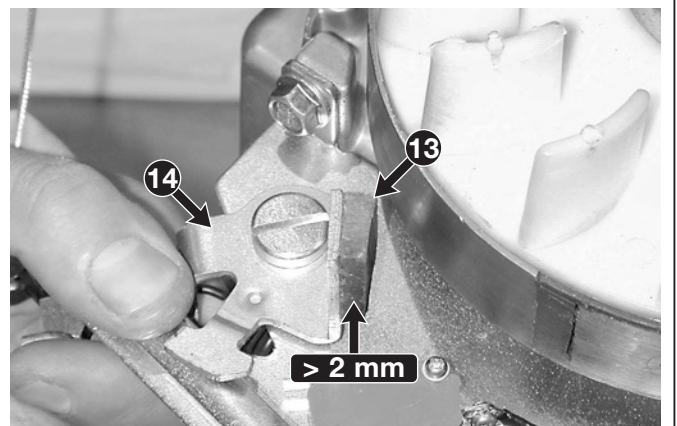

**⚠ WARNING! Never return the lawnmower to your client without checking brake efficiency.**

**D) Replacing the system for turning off and stopping the engine**

- 31 Remove the conveyor [↔ 6.2.A].
- 32 Disconnect the brake wire (21) from the lever (22).
- 33 Unscrew the stud bolt (23) and the screw (24) fastening the supporting bracket (25).
- 34 Disconnect the two cables (26) and (27) of the microswitch (28).
- 35 When mounting, check that the eyelet terminal of the earth cable (26) is correctly positioned under the bracket (25) and fastened by the stud bolt (23).
- 36 After making all the connections, check that the terminal (29) is correctly fixed onto the support (25) and that the wire (21) is correctly attached to the **outer hole** of the lever (22).
- 37 Remount the conveyor [↔ 6.2.A].
- 38 Start the engine, release the lawnmower lever and check that the engine stops within 3 seconds.

**⚠ WARNING! Never return the lawnmower to your client without checking brake efficiency.**

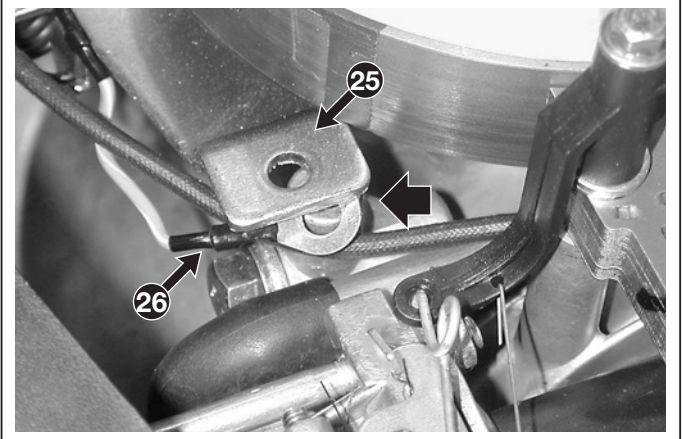
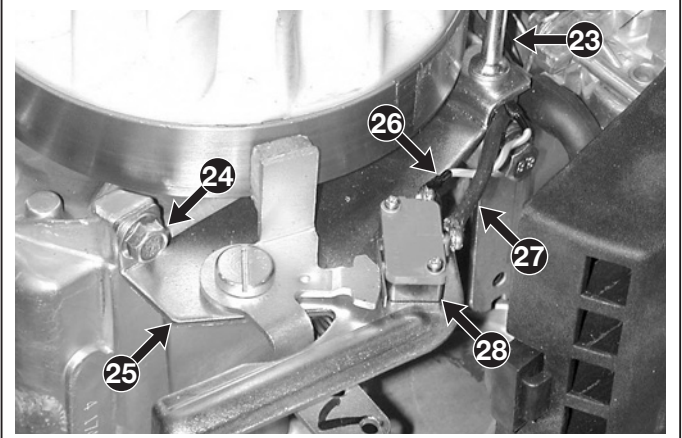
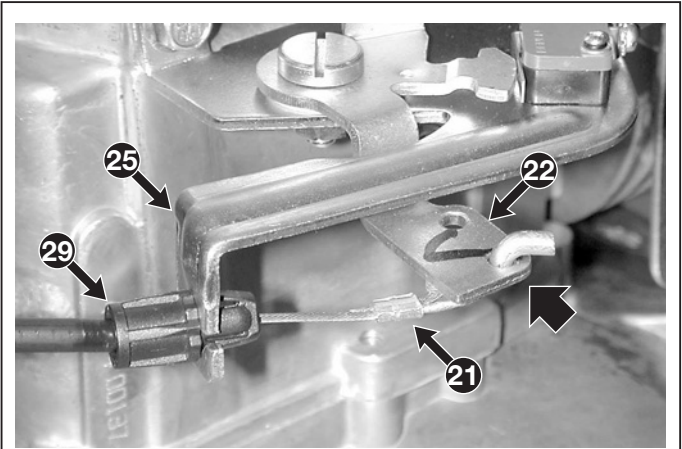

**Special equipment**

- Universal tester



|  |   |
|--|---|
| <p>6.8.1<br/><b>EXHAUST SYSTEM</b></p> | <p>from 2007 to</p> <hr/> <p>page 1 / 1</p> |
|--|---|

## 6.8 EXHAUST SYSTEM

### GENERAL INFORMATION

The exhaust system consists of a muffler installed on the cylinder together with a gasket, a spacer and a heatproof baffle.

A malfunctioning exhaust system may lead to a loss in power or excess noise. However, the muffler is a preassembled part which cannot and must not be disassembled or repaired but only replaced.

### SERVICING PROCEDURES

#### A) Removing and replacing the muffler

- 1 Remove the conveyor [\[→ 6.2.A\]](#).
- 2 Remove the cover (1) secured by three screws (2).
- 3 Unscrew the two nuts (3) and pull out the silencer (4), the heatproof baffle (5), the spacer (6) and the second baffle (7).
- 4 When mounting:
  - thoroughly clean the cylinder contact surface, removing all gasket deposits or fragments;
  - check the condition of the spacer (6);
  - always replace the heatproof baffle (5 - 7) if it is broken or cracked;
  - tighten the two nuts (3) to the specified levels and fold the two ends of the safety plate (8) to prevent the nuts from loosening.
- 5 Remount the conveyor [\[→ 6.2.A\]](#).

#### Tightening torques

- 3** Muffler nuts ..... 6-8 Nm

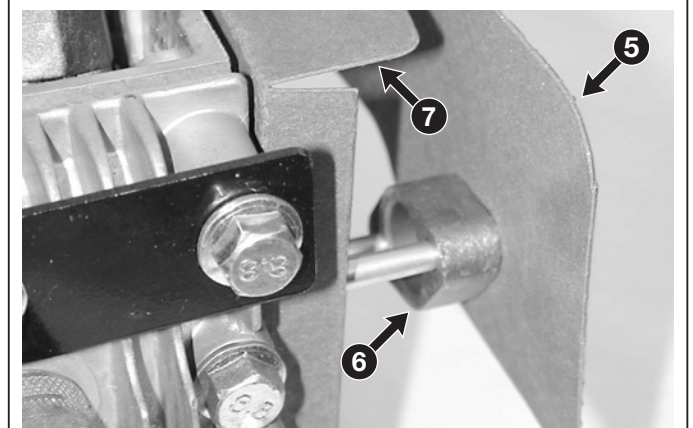
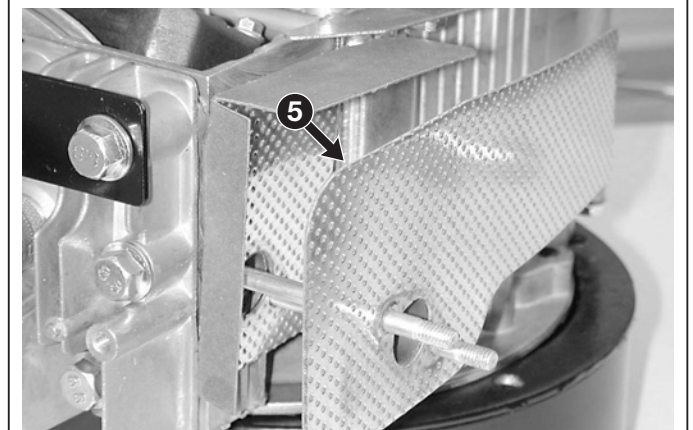
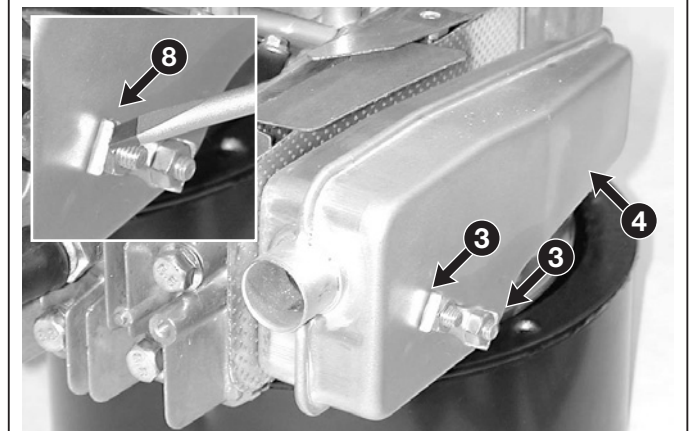
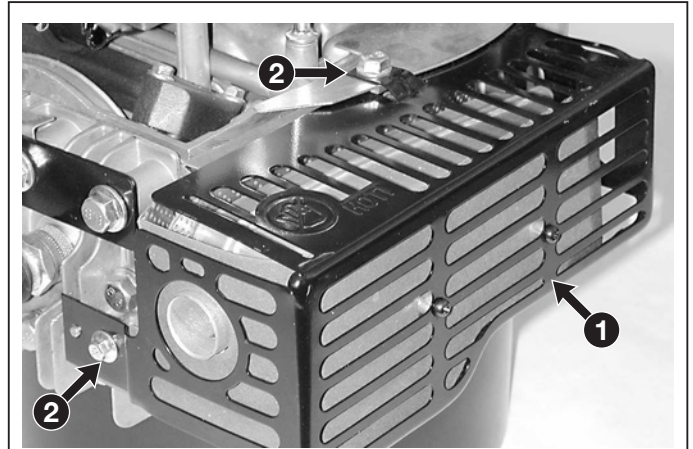



## 6.9.1 ENGINE BLOCK

from 2007 to

page 1 / 5 ▷

### 6.9 ENGINE BLOCK

#### GENERAL INFORMATION

*This engine is designed to significantly reduce the need for servicing internal part, which would often turn out so expensive that it would not be worth the money.*

*This chapter describes the only operations that can be carried out on the engine and how to replace it.*

#### SERVICING PROCEDURES

##### A) Cleaning the cylinder head

- 1 Remove the lever system support for carburettor adjustment [↔ 6.5.C] and the spark plug.
- 2 Loosen the screw (1) fixing the exhaust cover (2) to the cylinder head (3).
- 3 Undo the other five screws (4) securing the cylinder head (3).
- 4 Remove the gasket (5) and clean the cylinder head and cylinder surfaces.
- 5 Turn the flywheel manually to move the piston and the valves and clean inside the cylinder, removing any deposits from the valve seats.
- 6 When mounting:
  - the gasket (5) must always be replaced;
  - remount the cylinder head (3) and apply the five screws (4) without screwing them down tight;
  - remount the lever system support for carburettor adjustment [↔ 6.5.C] and the relative screws (6) without tightening them;
  - tighten the screws (4) and (6) to the specified levels following the sequence shown in the diagram: ① ② ③ ④ ⑤ ⑥ ⑦ ⑧.

##### B) Emptying the oil sump

- 11 Put the lawnmower on a stand (horizontally) to

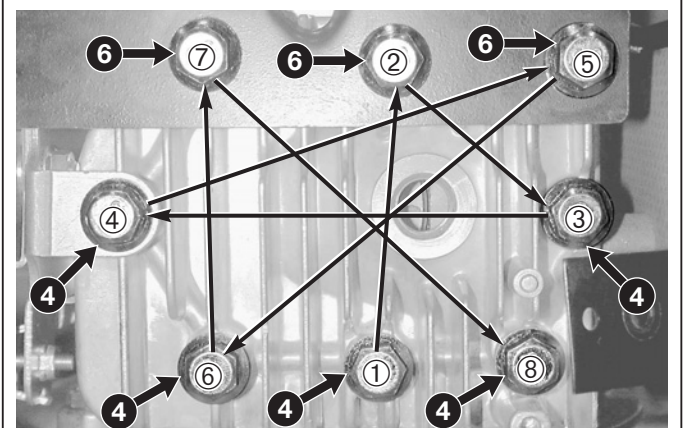
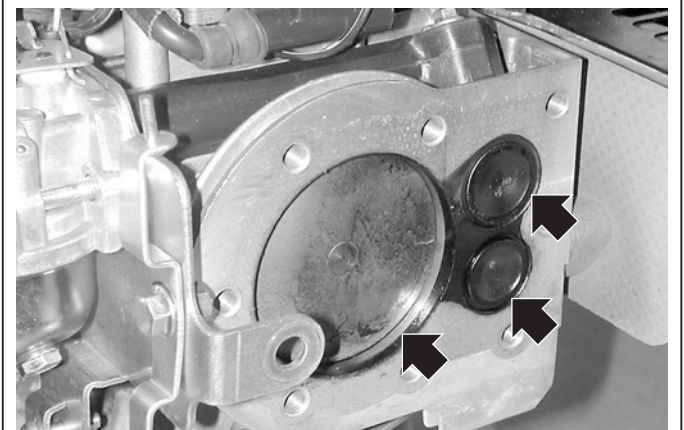
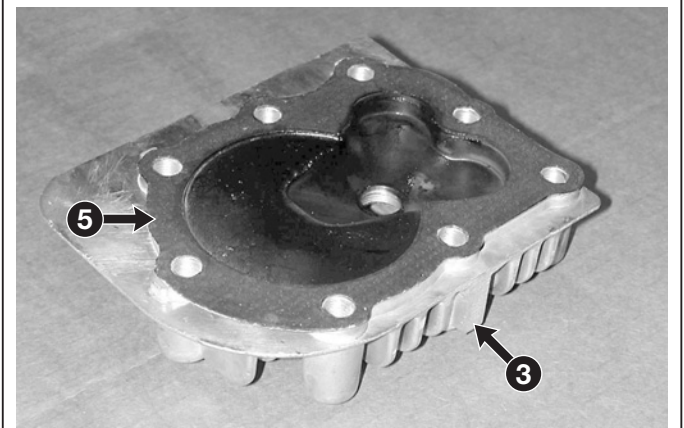
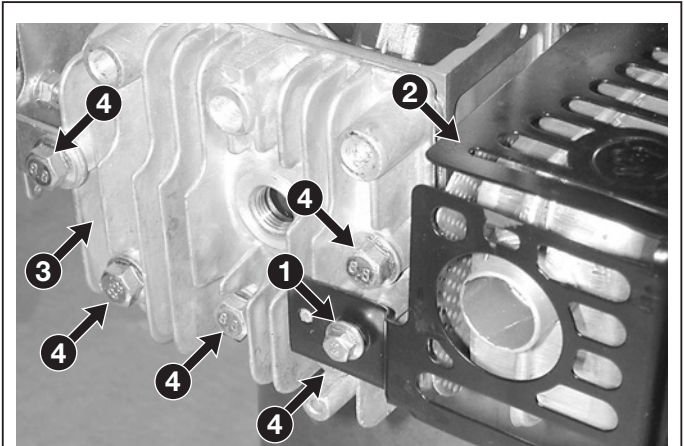





## 6.9.1 ENGINE BLOCK

from 2007 to

page ◀ 2 / 5 ▶

facilitate access to the lower part and drain all the oil.

- 12 Remove the oil filling cap (11) and position a suitable container for collecting the oil. Unscrew the drain plug (12) and let all the oil pour out.
- 13 When fitting the drain plug (12), check that the gasket underneath is intact and positioned correctly.

### C) Replacing the flywheel fan

- 21 Remove the conveyor [↪ [6.2.A](#)].

**N.B.** - Not having equipment able to lock the rotation of the engine shaft, removing and refitting the flywheel requires the use of a power screwdriver.

- 22 Remove the inside baffle (21).
- 23 Using a power screwdriver unscrew the nut (22) that locks the cup (23), the fan (24) and the magnet flywheel (25).
- 24 On assembly, check the alignment of the references on the cup (23) and the hub of the magnet flywheel.
- 25 Screw the nut (22) to the specified levels, with a power screwdriver.
- 26 Remount the conveyor [↪ [6.2.A](#)].

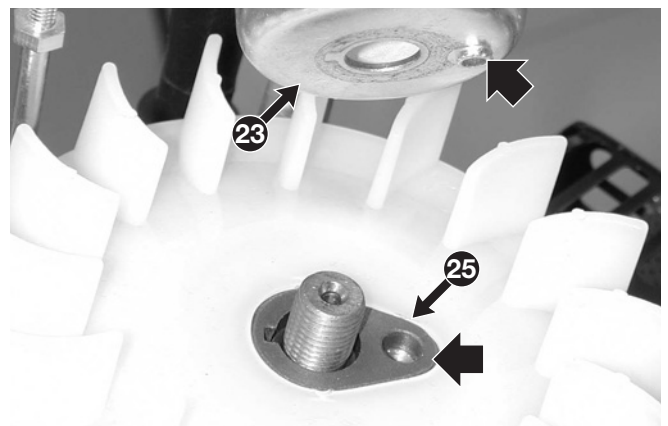
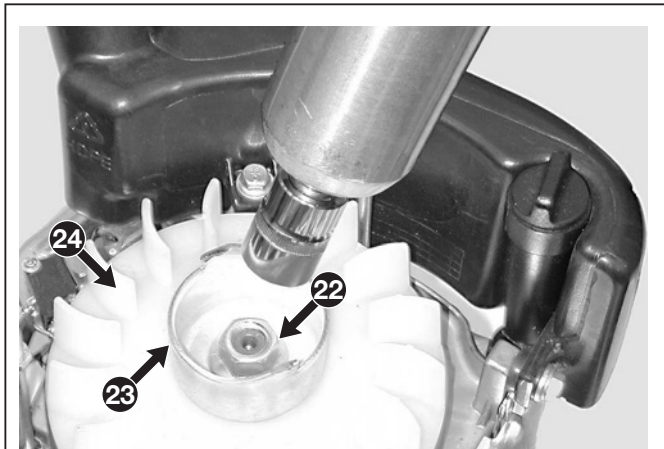
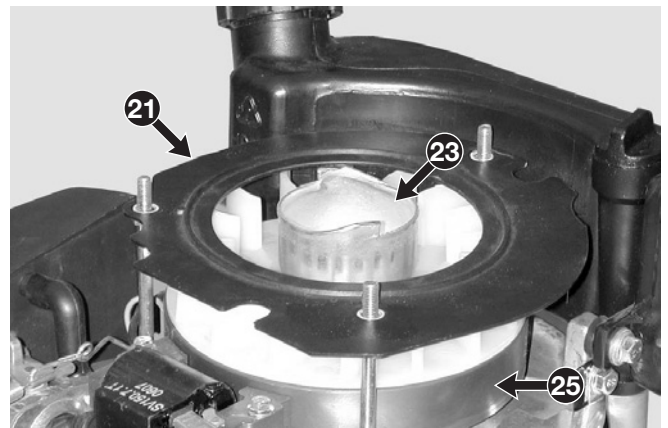
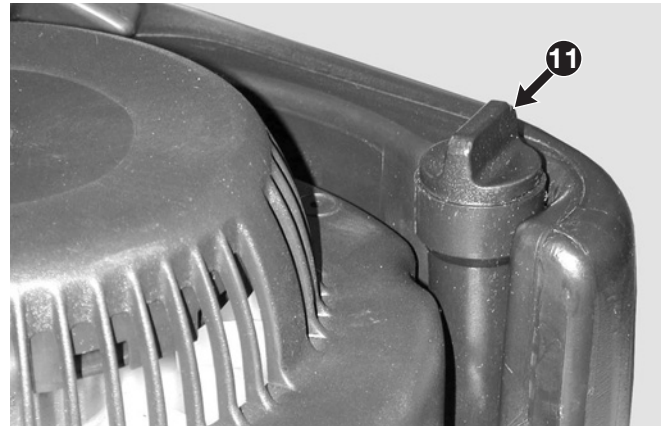





## 6.9.1 ENGINE BLOCK

from 2007 to

page ◀ 3 / 5 ▶

### D) Replacing the lower sealing ring of the engine shaft (sump side)

**N.B.** - This operation must be done by lifting the lawnmower from the front, after having drained all the oil from the sump and empties the fuel from the tank

- 31 Remove the blade (31) and the hub (32).
- 32 Take out the key (33)
- 33 Extract the oil seal ring (34) with the help of a thin screwdriver inserted under the sealing lip (34).
- 34 Form a paper tube (35) around the shaft to protect the sealing lip and insert the new ring (36) as far as the entry to its housing.
- 35 Complete the insertion with the help of a tube (37) of about 30-35 mm in diameter.

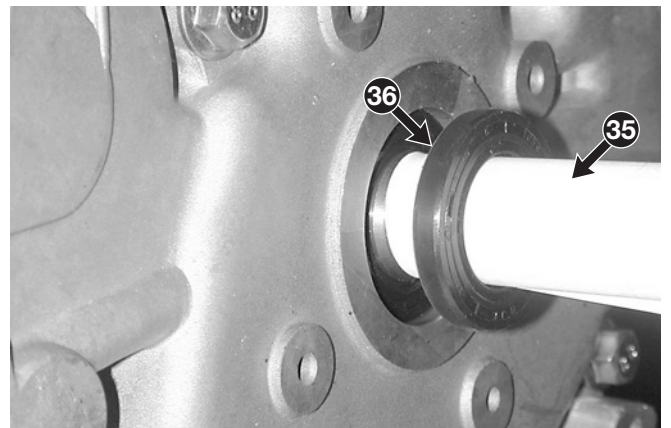
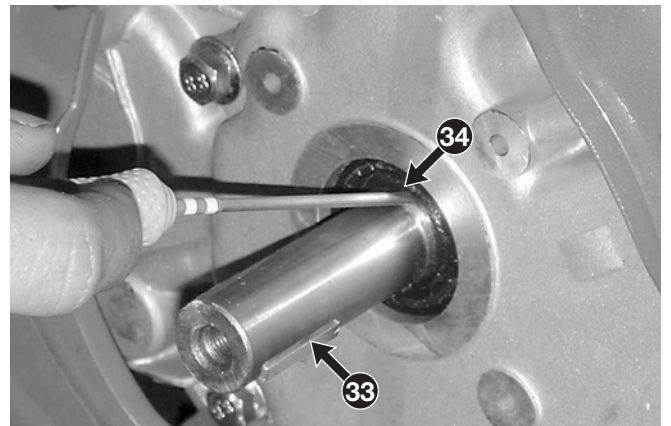
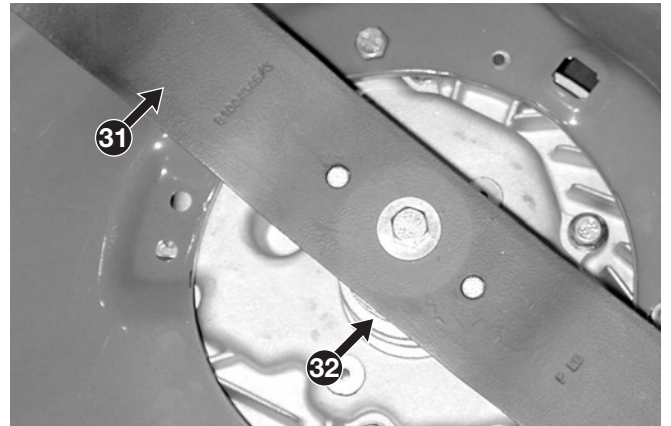

### E) Removing the engine

- 41 Empty the tank of fuel [➔ [6.1.A](#)].
- 42 Disconnect the throttle cable (41) and the engine brake cable (42).

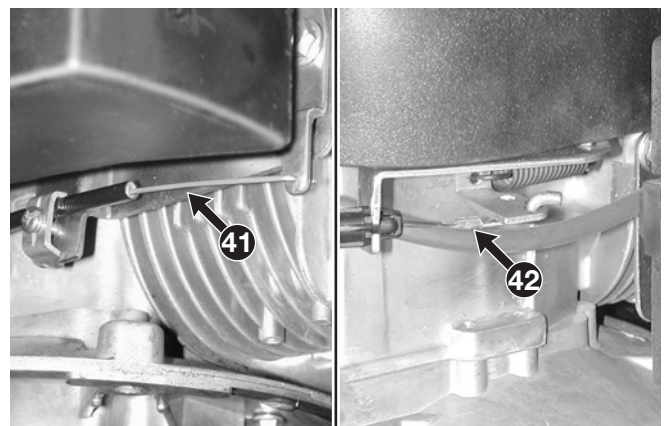
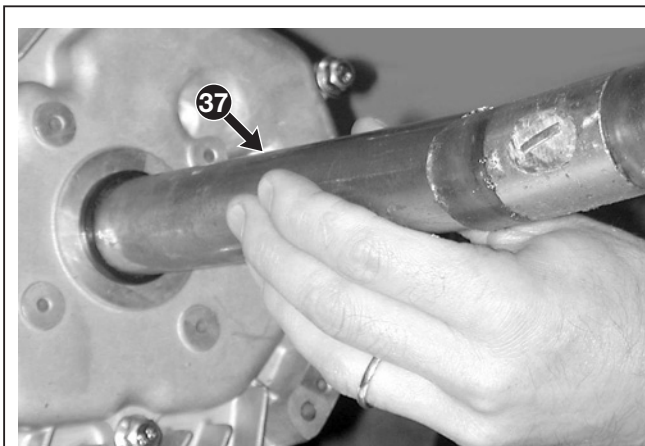



## 6.9.1 ENGINE BLOCK

from 2007 to

page ◀ 4 / 5 ▶

43 Dismount the cutting assembly and undo the 3 screws (43) which are accessible from the bottom of the lawnmower.

44 Hold the engine in points with a firm grip, remembering that it weighs approx. 10 kg.

45 When mounting,

- tighten the screws to the specified levels;
- check the efficiency of the engine brake [↪ 6.5.A];
- ⚠ check that the throttle cable is correctly adjusted [↪ 6.7.C].

### F) Opening the engine and replacing the oil sump gasket

51 Remove the engine [↪ point "E"].

52 Empty the crankcase [↪ point "B"].

53 Turn the engine over so that the shaft protrusion is to the top and position the engine on a stand that guarantees the necessary stability for performing the subsequent operations.

54 Dismount the sump (51) secured by six screws (52).

55 When mounting, follow the steps described in reverse and then

- always replace the gasket (53) between the crankcase and sump;
- ensure that the two centring pins (54) are inserted correctly;
- always replace the sealing ring (55) from the sump side [↪ point "D"];
- tighten the screws (52) to the specified levels as shown in the drawing: ① ② ③ ④ ⑤ ⑥.

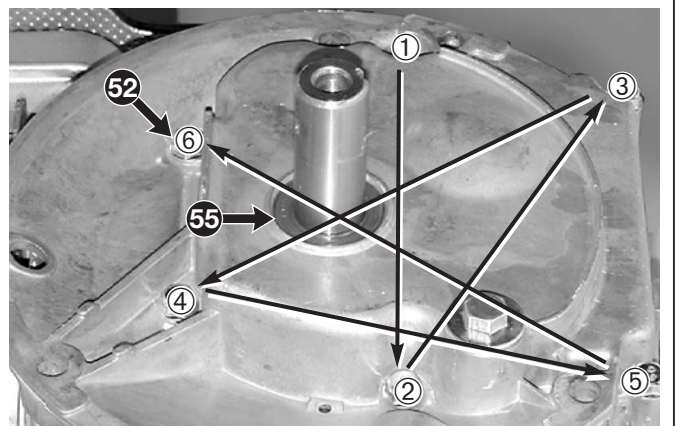
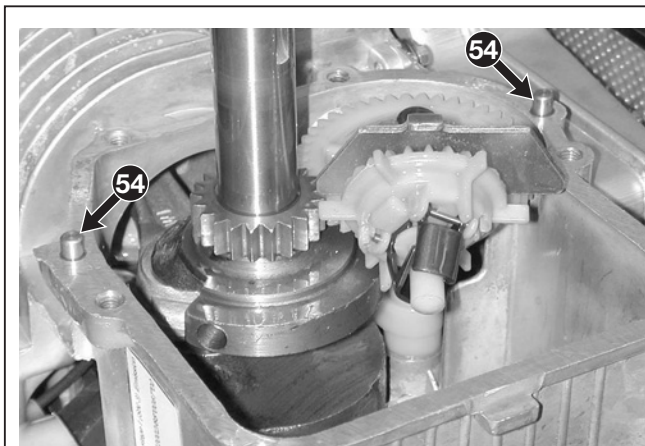
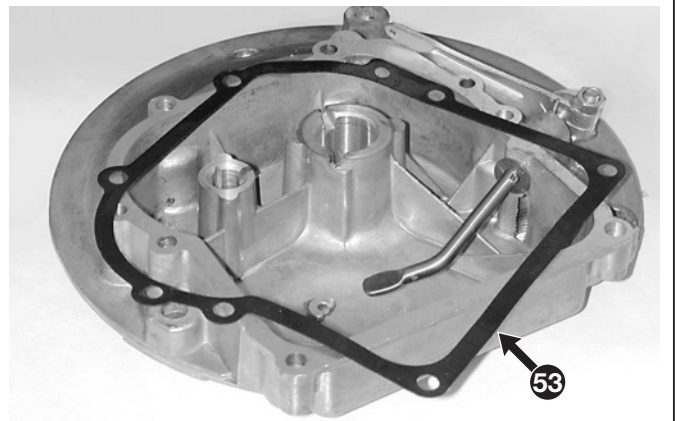
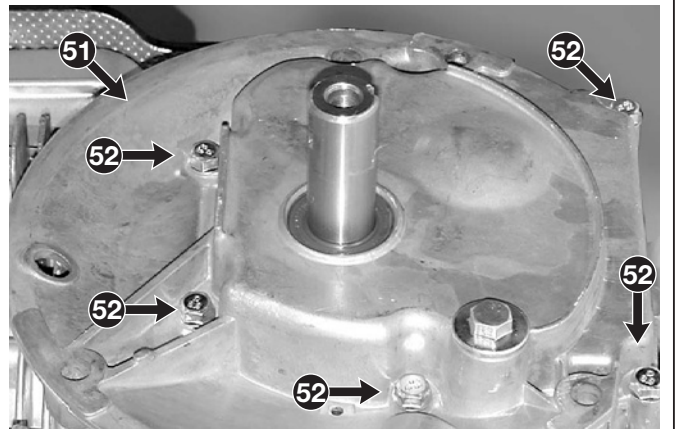



## 6.9.1 ENGINE BLOCK

from 2007 to

page ◀ 5 / 5

- 56 Ensure that the oil drain plug (56) is properly screwed in and fill the sump.
- 57 Remount the engine on the machine and carry out all the required checks [↩ [point "E"](#)].

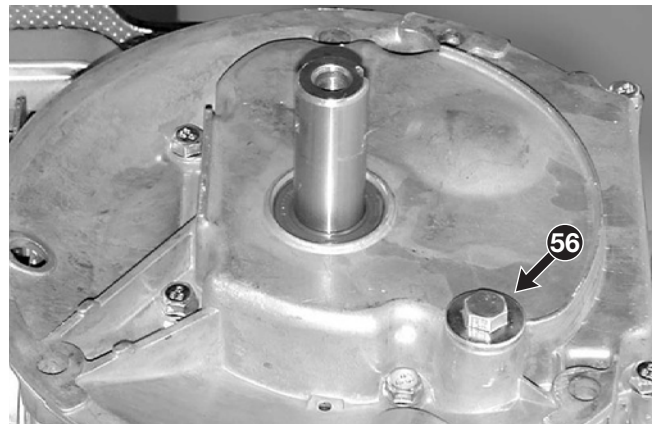

---

### Tightening torques

---

|              |                                  |          |
|--------------|----------------------------------|----------|
| <b>4-6</b>   | Cylinder head screws .....       | 20-25 Nm |
| <b>12-56</b> | Oil drain plug .....             | 18-22 Nm |
| <b>23</b>    | Flywheel fastening nut .....     | 40-60 Nm |
| <b>43</b>    | Engine screws .....              | 20-28 Nm |
| <b>52</b>    | Oil crankcase fastening screws . | 8-10 Nm  |