

MODEL	Gardenvac EV650
PRODUCT NO.	9648601, 9648605

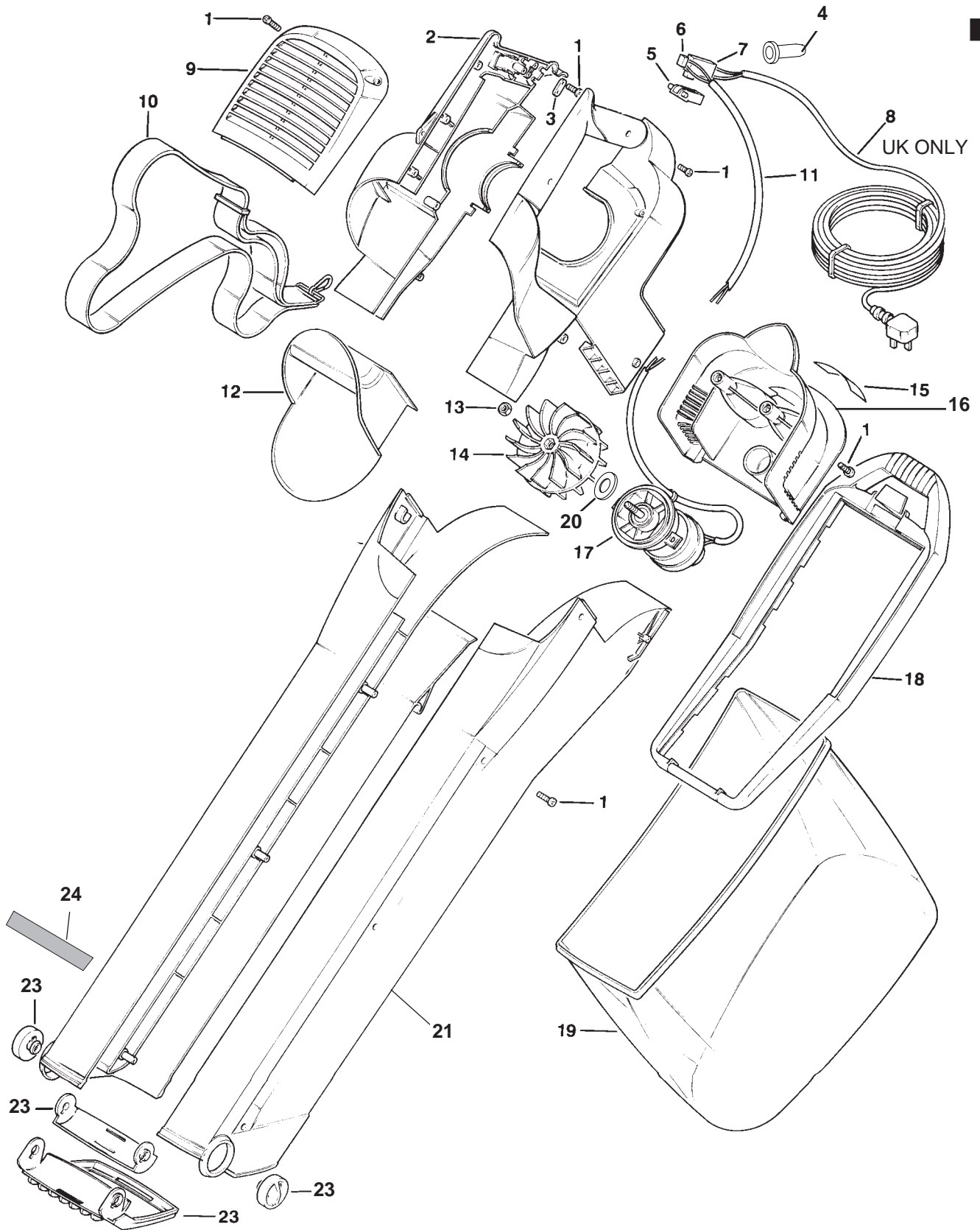

# Flymo

MODEL	Gardenvac EV650
PRODUCT NO.	9648601, 9648605



KEY	PART NUMBER	DESCRIPTION	QTY
01	5146672-00/0	SCREW	19
02	5149166-05/9	VOLUTES,PAIR OF	1
03	5140705-00/4	CABLE CLAMP	1
04	5148741-00/1	PROTECTION SLEEVE	1
05	5127302-00/7	SWITCH ACTUATOR	1
06	5148397-01/0	CAPACITOR	1
07	5137685-00/3	SWITCH	1 GB.EI.AUS
	5137894-00/1	SWITCH	1 CH.F.B.NL.D.E.P.I.N.S.DK.SF.A.
08	5127251-03/0	LEAD	1 GB.EI.
	5147000-02/9	LEAD	1 A.
	5147000-03/7	LEAD	1 CH.
	5148282-02/2	LEAD	1 F.B.NL.D.E.P.I.N.S.DK.SF.
	5138270-00/3	LEAD	1 AUS.
09	5106602-00/5	GRILL	1
10	5149105-00/8	STRAP	1
11	5138179-00/6	LEAD,INTERNAL ASSY	1
12	5127305-00/0	HANDLE PRINTED	1
13	5149106-00/6	NUT	1
14	5117740-67/9	IMPELLER	1
15	5138180-00/4	LABEL,WARNING	1
16	5106551-64/0	COVER,MOTOR	1
17	5150018-00/9	MOTOR	1
18	5106552-00/2	BAG FRAME	1
19	5106573-00/8	DEBRIS BAG	1
20	5149164-00/5	WASHER	1
21	5149165-05/1	TUBES,PAIR OF	1
23	5149271-00/8	WEAR PLATE KIT	1
24	5149112-00/4	LABEL	1

#### PRODUCT APPLICATION

9648601-01 GB.EI.	9648605-01 GB.EI
9648601-22 CH.	9648605-03 A.
9648601-86 F.B.NL.D.E.P.I.N.S.DK.SF.	9648605-22 CH.
9648601-99 AUS.	9648605-80 F.B.NL.D.E.I.N.S.DK.SF.

#### WHERE NO APPLICATION DETAILS ARE SHOWN, PART APPLIES TO ALL COUNTRIES

A Austria; AUS Australia; B Belgium; CND Canada; CH Switzerland; D Germany; DK Denmark; E Spain; EI Eire;  
F France; GB Great Britain; I Italy; N Norway; NL Netherlands; NZ New Zealand; O/S Overseas; P Portugal;  
S Sweden; SF Finland; USA America; ZA South Africa