

MODEL 403016x58A

REPAIR PARTS CHASSIS & HOOD ASSEMBLY

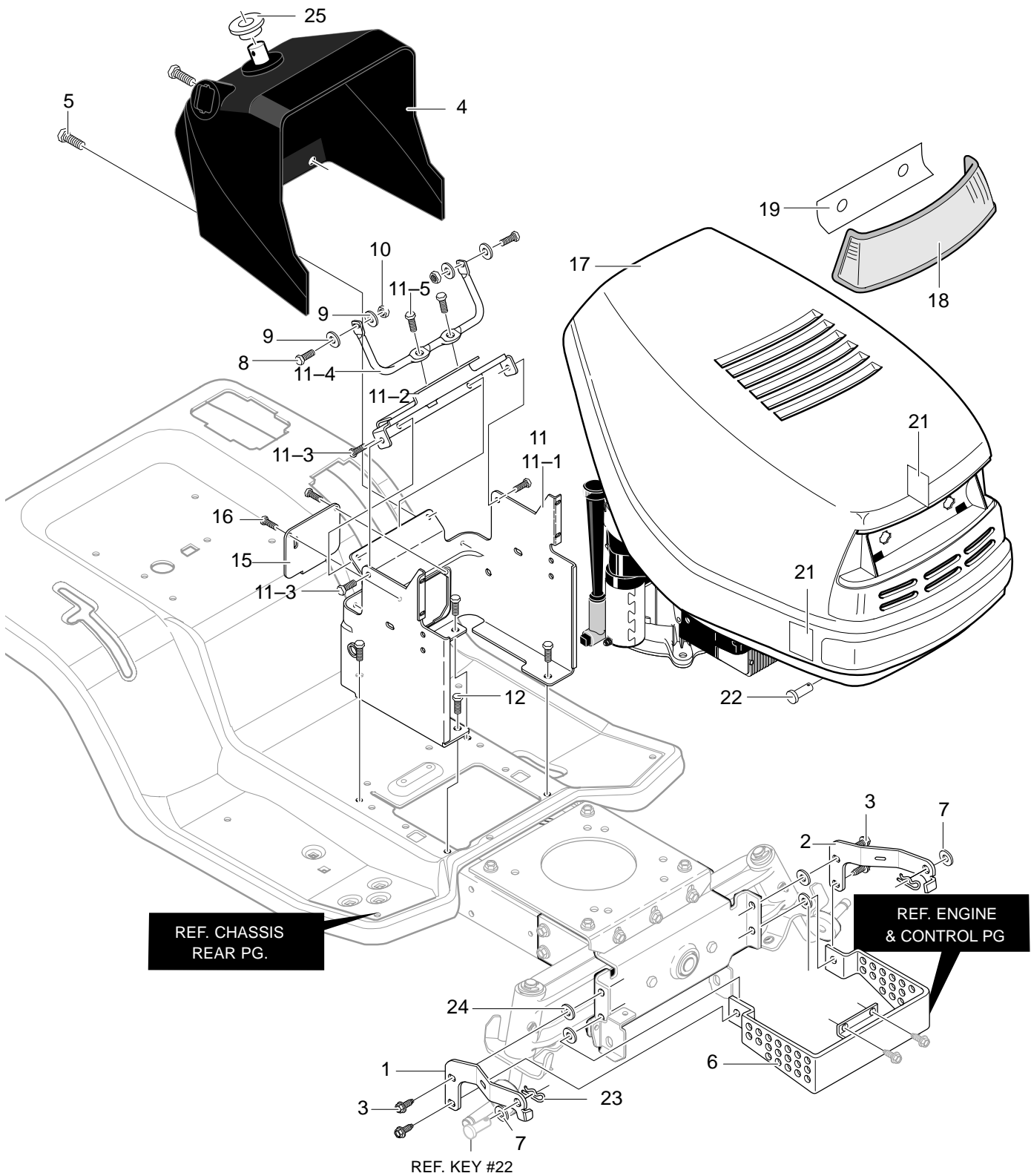

344695A

MODEL 403016x58A

REPAIR PARTS CHASSIS & HOOD ASSEMBLY

Key No.	Description	Part No.	Key No.	Description	Part No.
1	Bracket, Hood RH	95432-821	11-4	Rod, Dash Brace	95406
2	Bracket, Hood LH	95433-821	11-5	Screw, 1/4-20x.50	710264
3	Screw, 5/16-18x.75	711606	12	Screw, 10-24x.50	711606
4	Dash	690630	15	Panel, Access	95270-898
5	Screw, 1/4-14x.75	711762	16	Screw, 10-24x.50	711629
6	Heat Shield Guard	95195-821	17	Hood	94950
7	Washer, Flat Insulate	712480	18	Lens, Headlamp	302670
8	Screw, 1/4-20x.75	302628	19	Foil, Lens	308492
9	Washer, Flat .286x.63x.065	71067	21	Foil, Heat Reflector	301452
10	Nut, 1/4-20 Reghexctrlk	73826	22	Pin, Clevis	711856
11	Assembly, Lower Console	341569-898	23	Hair Pin	711682
11-1	Tower, Lower Dash	95425	24	Washer, Plastic	6711
11-2	Support, Steering	95426	25	Bushing, Steering Shaft	95404
11-3	Screw, 1/4-20x.50	710264	—	Instruction Book & Parts List	F-010712J

MODEL 403016x58A

REPAIR PARTS REAR CHASSIS ASSEMBLY

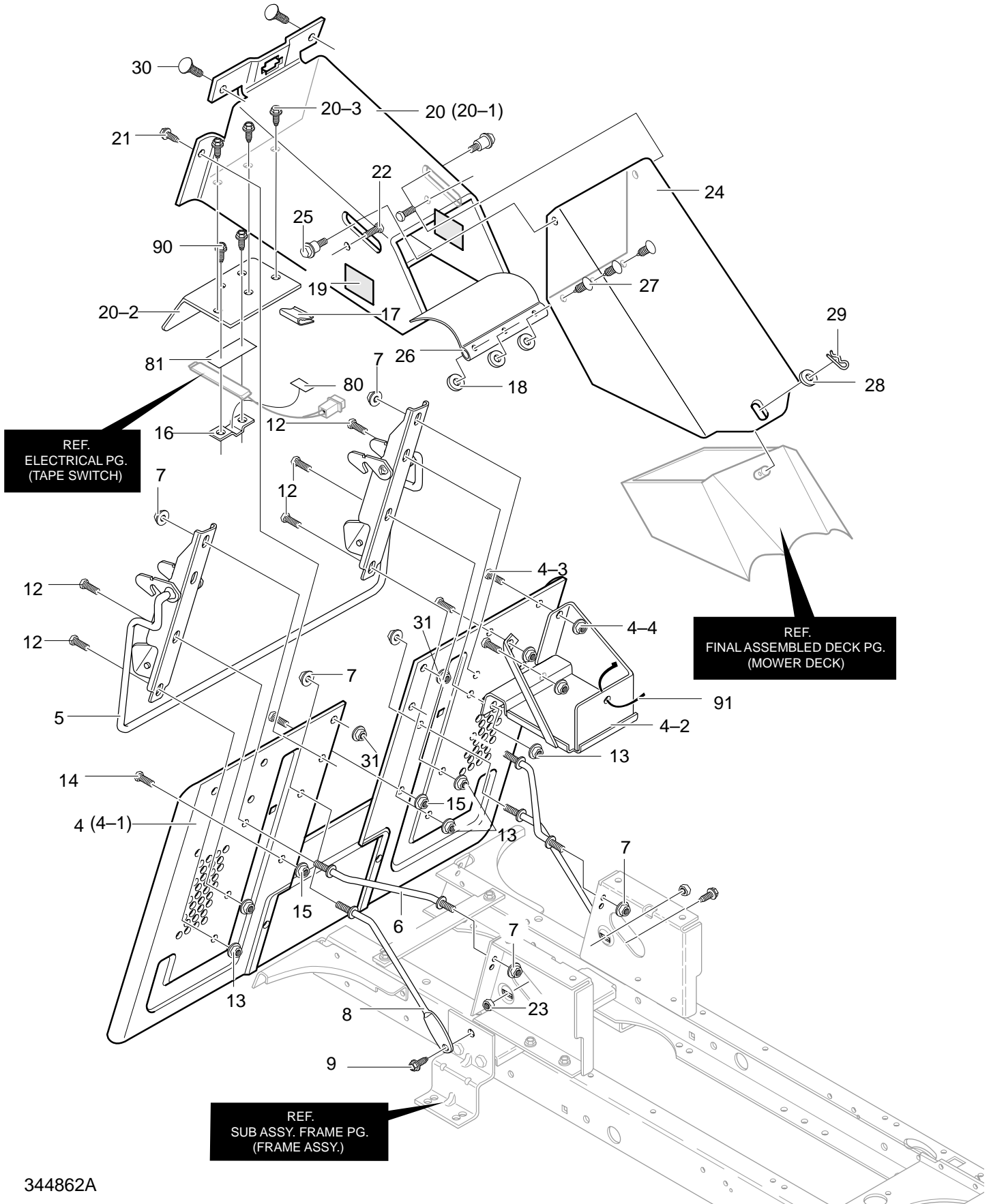

MODEL 403016x58A

REPAIR PARTS REAR CHASSIS ASSEMBLY

Key No.	Description	Part No.	Key No.	Description	Part No.
4	Assy., Back Plate/Battery	1001068-821	20-1	Chute Weld Asm. Upper	94350
4-1	Assy. Back Plate Flat	95162	20-2	Shield, Transaxle	95367
4-2	Battery Tray Assembly	94563	20-3	Screw, 1/4-20x.63	711642
4-3	Screw, 5/16-18x.50	180073	21	Screw, 5/16-18x.75	711606
4-4	Nut, 5/16-18 Hex	45174	22	Bolt, Carriage 5/16-18x.75	340720
5	Weldment-Latch Lever	95359-821	23	Nut, 5/16-18	710026
6	Rod, Brace	690097	24	Middle Chute Assembly	94296-821
7	Nut, 3/8-16 Hwdfl Whiz-lock	711906	25	Shoulder Bolt	009x57
8	Rod, Brace	94231	26	Flap, Chute	94264
9	Screw, 5/16-18x.75	711606	27	Fastener, Ratchet	309235
12	Screw, 5/16-18x.75	9357	28	Flatwasher	711617
13	Nut, 5/16-18 Hex Whiz	710026	29	Pin, Hair	711682
14	Screw, 5/16-18x.75	711606	30	Bolt, Carriage 5/16-18x.75	340720
15	Nut, 5/16-18 Hex Whiz	710026	31	Nut, 5/16-18	710026
16	Bracket, Flex Switch Mounting	690245	80	Tape, Double Sided Foam 3/4"	712009
17	Wire Clip, Adhesive	55939	81	Tape, Double Sided Foam 3/4"	712009
18	Flatwasher	711666	90	Screw, 1/4-20x.63	711642
19	Pad, Adhesive	318197	91	Cable Tie	57444
20	Asm., T/A Shield & Upper Chute	690102-821			

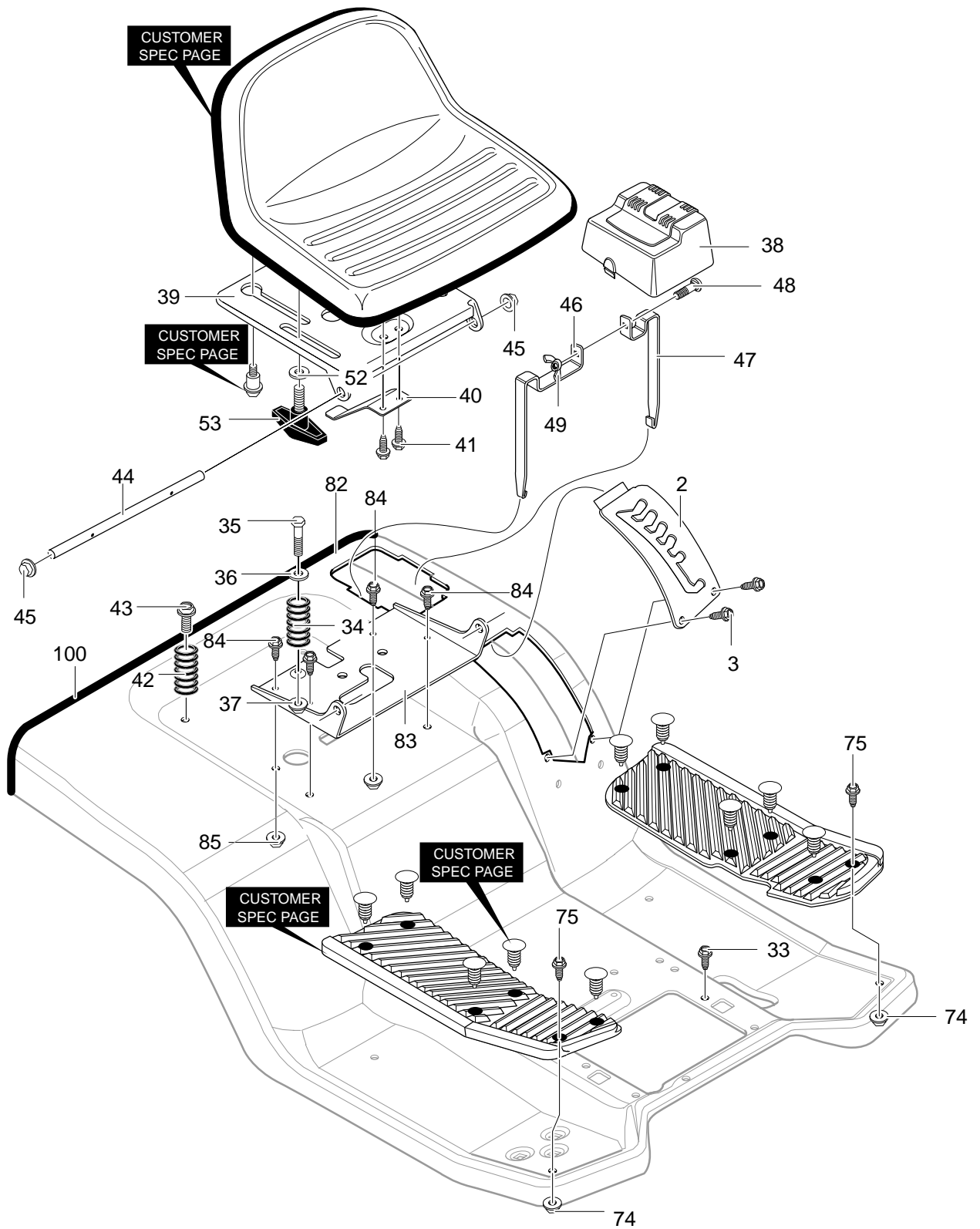

MODEL 403016x58A

REPAIR PARTS REAR CHASSIS ASSEMBLY

Key No.	Description	Part No.	Key No.	Description	Part No.
2	Plate, Lift Detent	95190-821	45	Nut, Push Cap	711627
3	Screw, #12x.50	711741	46	Battery Bracket, LH	95393-821
33	Screw, 5/16-18x.75	711606	47	Battery Bracket, RH	95394-821
34	Spring, Compression	710136-821	48	Bolt, Carriage 1/4-20x.63	711680
35	Shoulder Bolt 1/4-20	711610	49	Nut, Wing 1/4-20	711636
36	Zinc Washer Cup	95293	52	Washer, Flat	711644
37	Nut, 1/4-20 Centerlock	302635	53	Bolt, Wing 5/16-18x.50	711747
38	Cover, Battery	94200	74	Nut, 5/16-18	710026
39	Support, Seat	94154-898	75	Bolt, Carriage 5/16-18x.75	711891
40	Spring-Leaf	94057	82	Seat Deck Pedal	94204-898
41	Screw, 1/4-20x.50	711592	83	Bracket, Pivot Seat	94153-898
42	Spring, Compression	710109-821	84	Screw, 5/16-18x.75	711606
43	Screw, 5/16-18x.75	711606	85	Nut, 5/16-18	711634
44	Hinge Seat Pivot	95294	100	Trim 41.00 Inches	95105

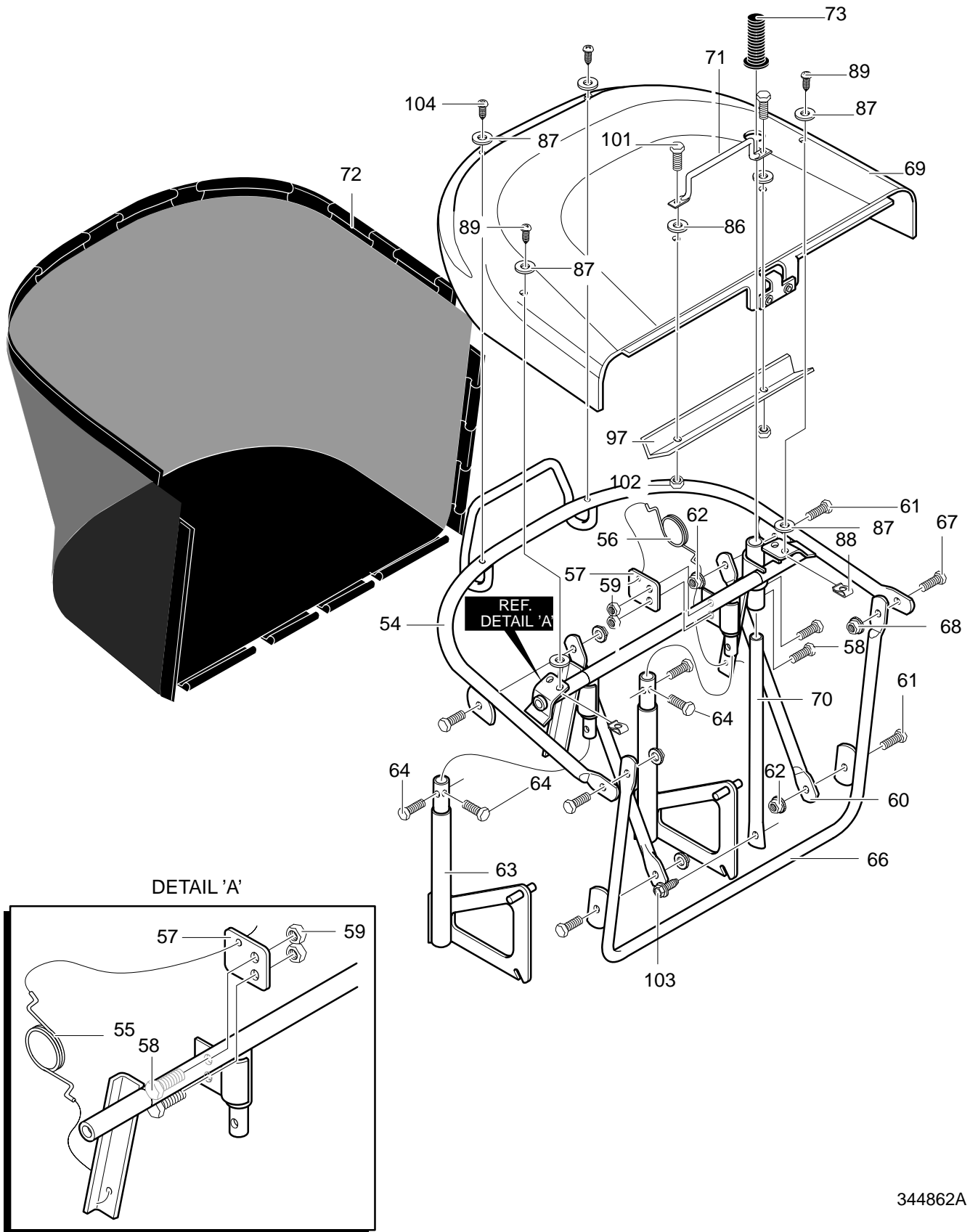

MODEL 403016x58A

REPAIR PARTS GRASS BAGGER ASSEMBLY

Key No.	Description	Part No.	Key No.	Description	Part No.
54	Asm. Weld Upper Frame	690044-821	69	Top Collector Assembly	94908-898
55	Spring, Torsion RH	690003	70	Handle, Dump Collector	690019
56	Spring, Torsion LH	690004	71	Handle, Reba Collector	690506-821
57	Bracket, Spring Collector	95339-821	72	Reba Collector Bag	95389
58	Screw, 1/4-20x.50	711909	73	Rubber Grip	94854
59	Nut, 1/4-20	303008	86	Washer	712129
60	Brace, Frame Collector	94850-821	87	Washer	711921
61	Screw, 1/4-20x.62	711909	88	Nut, 1/4-20 Tinnerman	578107
62	Nut, 1/4-20	303008	89	Screw, 1/4-20x.63	711674
63	Weld Asm. Support Collector	95343-821	97	Brace, Bagger	690010-821
64	Screw, 1/4-20x1.50	711653	101	Screw, 1/4-20x1.50	712068
66	Weld Asm. Front Frame Collect	95349-821	102	Nut, 1/4-20	711632
67	Screw, 1/4-20x.62	711909	103	Screw, #12x.50	711741
68	Nut, 1/4-20	711632	104	Screw, #12x.50	711741

MODEL 403016x58A

REPAIR PARTS FRAME ASSEMBLY

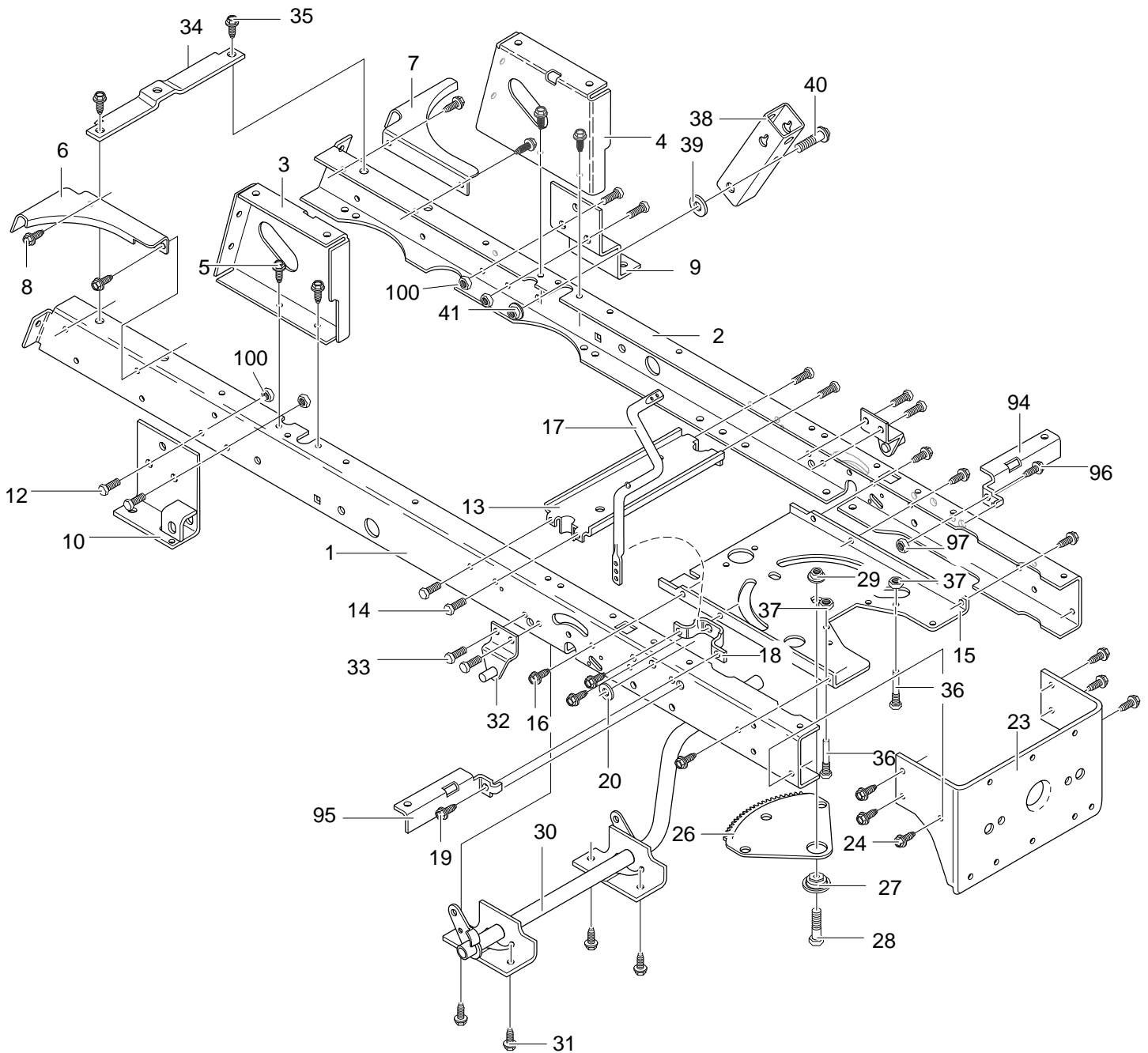

343659B

MODEL 403016x58A

REPAIR PARTS FRAME ASSEMBLY

Key No.	Description	Part No.	Key No.	Description	Part No.
1	Frame, Rail RH	94564	26	Gear, Sector	94121
2	Frame, Rail LH	94565	27	Bearing, Sector Gear	94123
3	Support, Seat RH	94634	28	Screw, 5/16–18x1.00	001X84
4	Support, Seat LH	94633	29	Nut, 5/16–18	15X113
5	Screw, .312–18x.75	26X249	30	Clutch/Brake Pedal	94241
6	Brace, BackPlate RH	94561	31	Screw, .312–18x.75	26X249
7	Brace, BackPlate LH	94562	32	Bracket, Suspension Asm.	94285
8	Screw, 5.312–18x.75	26X249	33	Screw, .312–18x.75	26X249
9	Bracket, T/A RH VST LH MST	94234	34	Brace, Rail	94566
10	Assy., Shift Brace	95396	35	Screw, .312–18x.75	26X249
12	Screw, .312–18x.75	26X249	36	Zinc Screw Guide	93349
13	Assy., Idler Mount, Front	94237	37	Nut, 5/16–18	015X79
14	Screw, .312–18x.75	26X249	38	Bracket, Pivot	94015
15	Plate, Steering	690551	39	Washer, Flat	845
16	Screw, .312–18x.75	26X249	40	Bolt, Shoulder 3/8–16	009X53
17	Crank, PTO	690394	41	Nut, 3/8–16	015X84
18	Bracket, Bell Crank	94005	94	Bracket, Seat Deck LH	690036
19	Screw, .312–18x.75	26X249	95	Bracket, Seat Deck RH	690035
20	Washer, Flat	120395	96	Screw, .312–18x.75	26X249
23	Bracket, Hanger Rear	94013	97	Nut, 5/16–18	015X79
24	Screw, .312–18x.75	26X249	100	Nut, 5/16–18	015X88

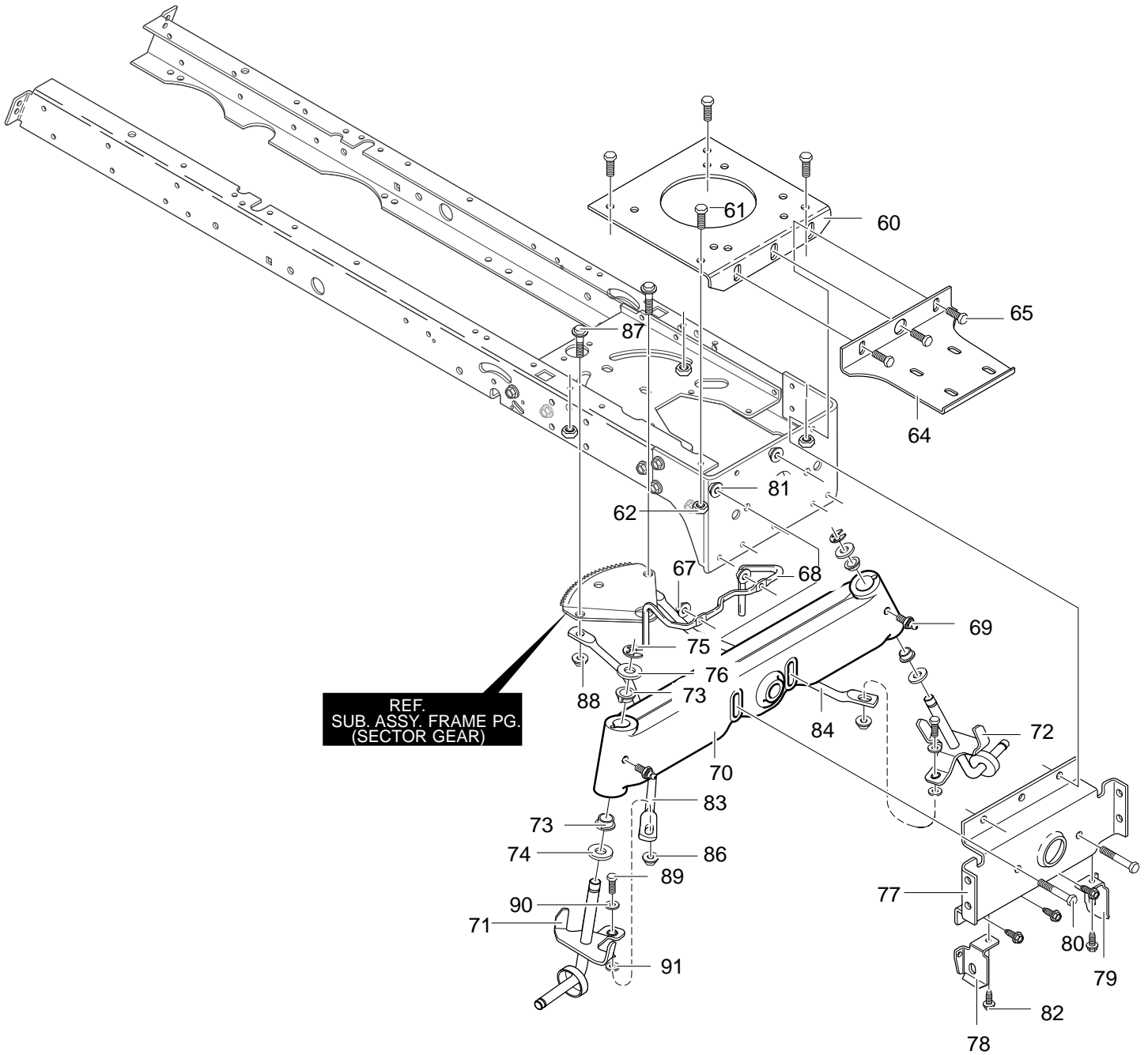

MODEL 403016x58A

REPAIR PARTS FRAME ASSEMBLY

Key No.	Description	Part No.	Key No.	Description	Part No.
60	Engine Plate	94006	77	Hanger, Axle	94007
61	Screw, .312-18x.75	26X249	78	Hanger, Deck RH	690199
62	Nut, 5/16-18	015X88	79	Hanger, Deck LH	690198
64	Bracket, Muffler Mount	94901	80	Screw, 5/16-18x3.00	180113
65	Screw, .312-18x.75	26X249	81	Nut, 5/16-18	015X88
67	Nut, 5/16-18	45174	82	Screw, .312-18x.75	26X249
68	Guide-Stack Pulley Belt	94310	83	Drag Link, RH	95328
69	Zerk, Grease	706	84	Drag Link, LH	95329
70	Axle, Cast Machined	95405	86	Nut, 3/8-16	015X84
71	Spindle, Long RH	95182	87	Shoulder Bolt	9X57
72	Spindle, Long LH	95183	88	Nut, 3/8-16	015X84
73	Bearing, Spindle	92527	89	Screw, 3/8-16x1.50	01X111
74	Washer, .766IDx1.62ID	17X113	90	Flatwasher	17X104
75	E-Ring	0011X3	91	Flatwasher	017X53
76	Washer, Flat	17X195			

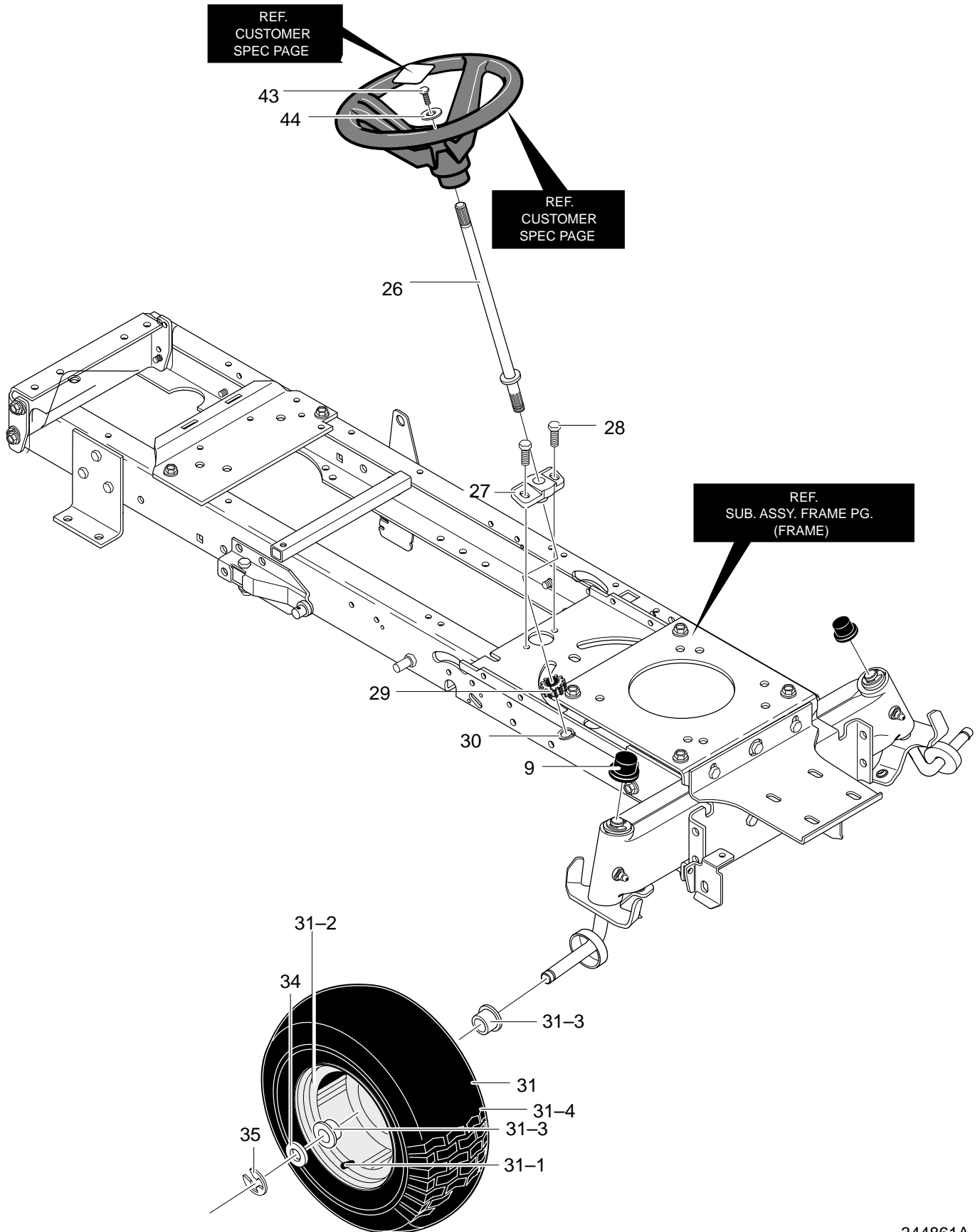

Key No.	Description	Part No.
9	Dust Hub Cap	94618
26	Shaft, Steering	94520
27	Bearing—Lower	94124
28	Screw, 5/16—18x.75	711606
29	Gear, Pinion	94122
30	Retaining Ring	710102
31	Tire & Rim	692641
31-1	Valve Stem	338512
31-2	Rim	338517
31-3	Bearing	338513
31-4	Tire	338514
34	Flatwasher	711758
35	E—Ring	0011x3
43	Screw, 1/4—20x.75	711719
44	Flatwasher	711663
—	Hub Cap	94618

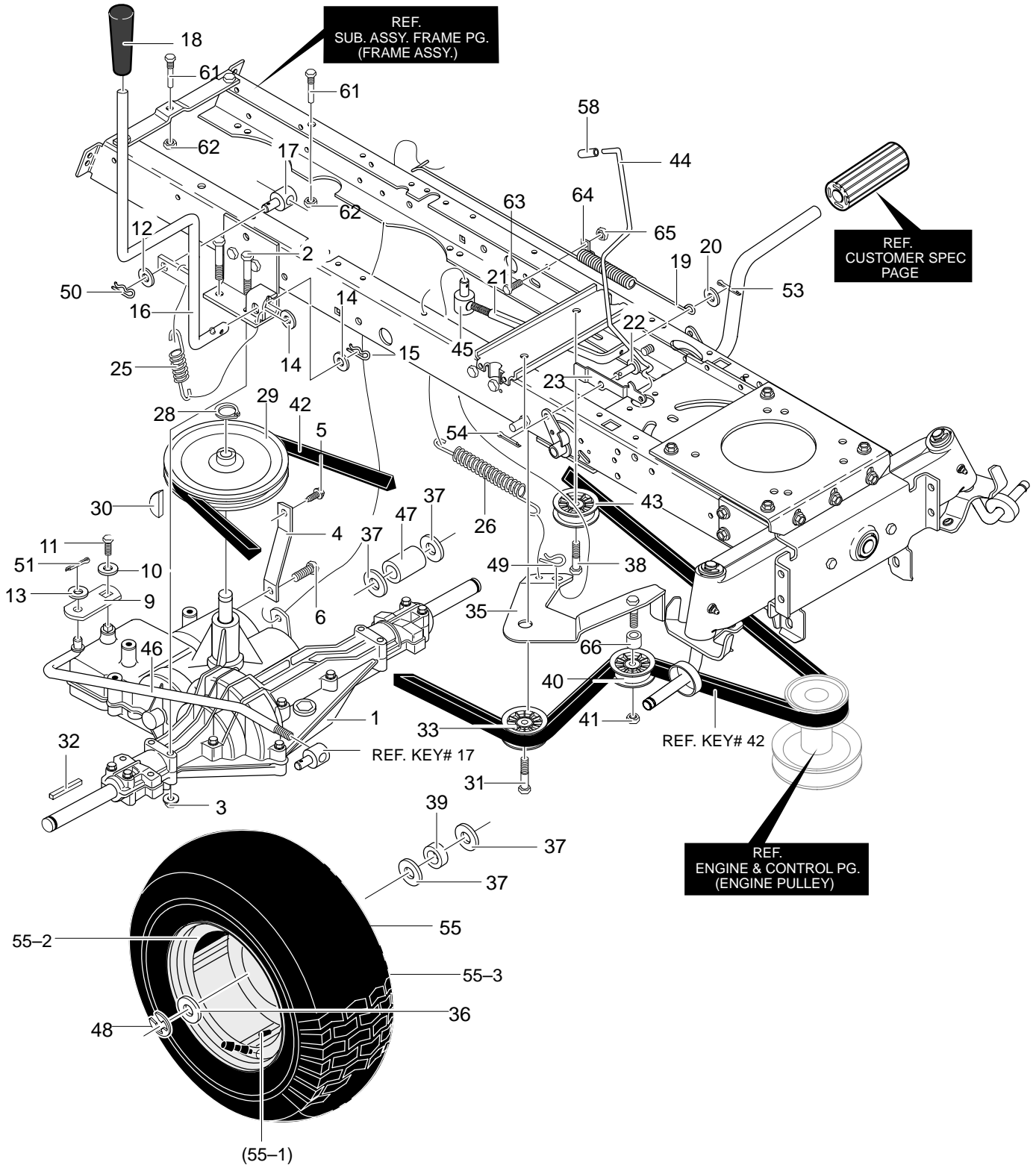

MODEL 403016x58A

REPAIR PARTS MOTION DRIVE

Key No.	Description	Part No.	Key No.	Description	Part No.
1	Transaxle, MST206	*	36	Washer, Flat	711758
2	Screw, 5/16–18X2.50	711669	37	Washer, Flat	711904
3	Nut, 5/16–18	711634	38	Screw, 3/8–16x1.25	711905
4	Bracket, Stabilizer	94620–821	39	Spacer	95418
5	Screw, 5/16–18x.75	711606	40	Pulley, Idler	690409
6	Screw, 5/16–18x.75	710268	41	Nut, 3/8–16	711920
9	Bracket, Shift	94227	42	Belt, V 4L 114.12	94608
10	Washer, Transaxle	711895	43	Pulley, Idler	1001065
11	Screw, 1/4–28x.750	01x145	44	Park Brake control Rod	690046
12	Washer, Flat	583409	45	Nut, 5/16–18 Adjusting	711898
13	Washer	71072	46	Rod, Shift Link	690027
14	Flatwasher	711894	47	Spacer	95419
15	Hair Pin	711899	48	E–Ring	0011x3
16	Shift Lever	690087	49	Pin, Hair	711659
17	Nut, Adjust	711591	50	Pin, Hair	711682
18	Grip	94929	51	Pin, Cotter	71081
19	Spring, Brake	95424	53	Pin, Cotter	71081
20	Washer, Flat	711921	54	Pin, Cotter	71081
21	Rod, Clutch	690016	55	Tire & Rim	692511
22	Pin, Clevis	711903	55–1	Valve Stem	338512
23	Latch, Park Brake	95290	55–2	Rim	338524
25	Spring	782223	55–3	Tire	338525
26	Spring, Tension	711522	58	Cap, Dump	335980
28	Ring, Ret	0011x7	61	Screw Guide	20619
29	Pulley, 9.0 ODV4L	94571	62	Nut, 1/4–20	710026
30	Key, Hi Pro 606	50795	63	Screw, 1/4–20x.50	313686
31	Screw, 3/8–16x1.25	711905	64	Retainer	711742
32	Key, Square	52928	65	Nut, 1/4–20	780285
33	Pulley, Idler	1001065	66	Spacer 1/2 to 17MM	690369
35	Assy, Idler Arm Traction	94238–821	—	Hubcap	94618

* Contact your nearest transaxle dealer for parts and service.

For information on Replacement Parts see the Central Parts Distributor in your area.

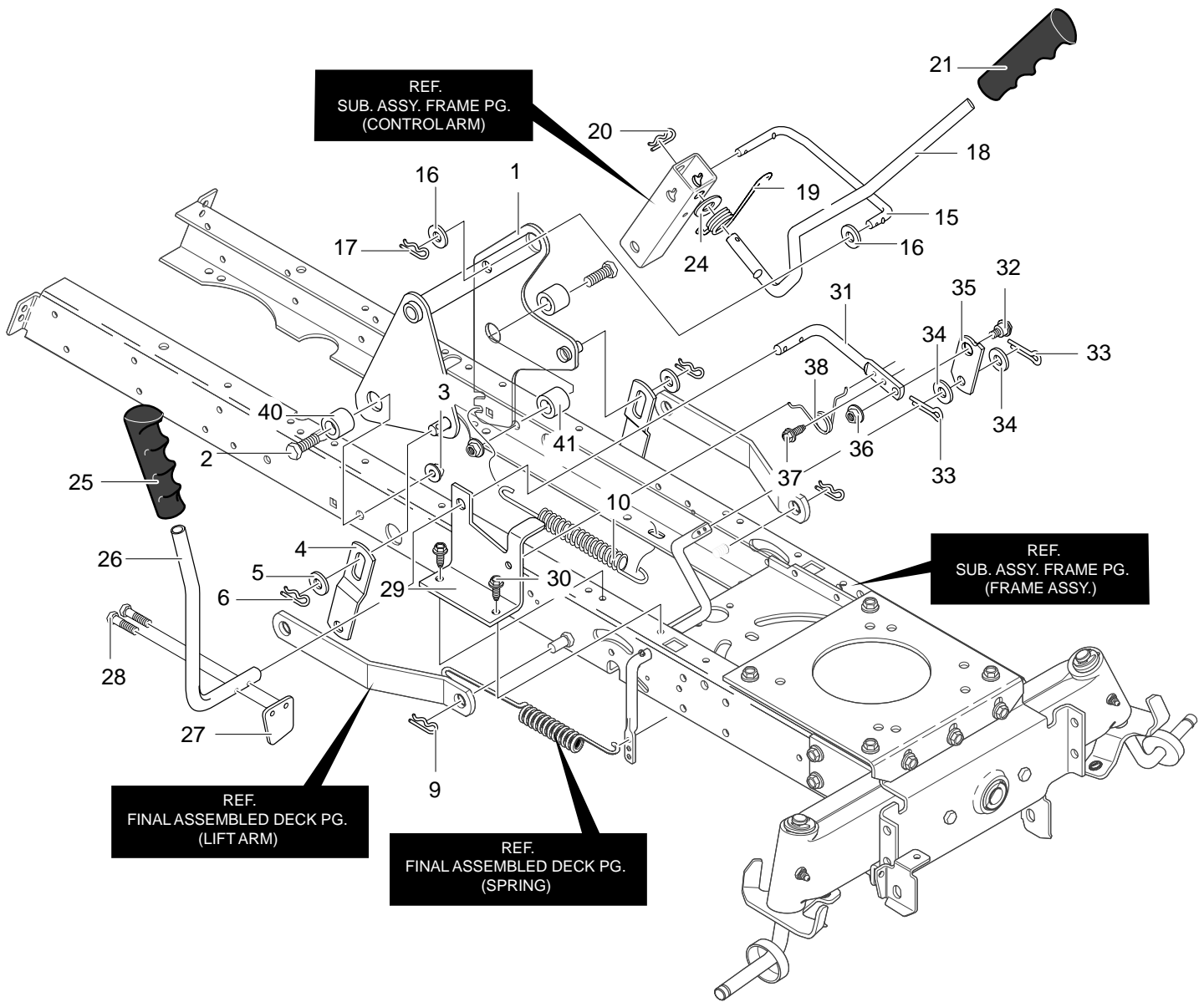

MODEL 403016x58A

REPAIR PARTS MOWER SUSPENSION ASSEMBLY

Key No.	Description	Part No.	Key No.	Description	Part No.
1	Assembly, Lift Arm	95233-821	25	Grip	94928
2	Screw, 1/2-13x1.50	711917	26	PTO Handle	690126
3	Nut, 1/2-13 Lock	711918	27	Paddle, Switch	95284
4	Bracket, Lift Link	94262-821	28	Screw, Thread Form	711621
5	Washer, Flat	711617	29	Bracket, PTO	94018-821
6	Hair Pin	711676	30	Screw, 5/16-18x.50	780055
9	Hair Pin	711676	31	Lever, PTO	95283
10	Spring, Extension	710235	32	Bolt, Shoulder 3/8-16	711613
15	Link-Lift Handle	711981	33	Hair Pin	711659
16	Washer, Flat	711617	34	Washer, Flat	711615
17	Hair Pin	711676	35	Link PTO	95282
18	Handle, Lift	690532	36	Nut, 3/8-16	711622
19	Torsion Spring	710111	37	Screw 5/16-18x.75	711606
20	Hair Pin	711676	38	Torsion Spring	710141
21	Grip, Lift	94929	40	Spacer	94309
24	Washer, Flat	711616	41	Spacer, Sleeve	56150

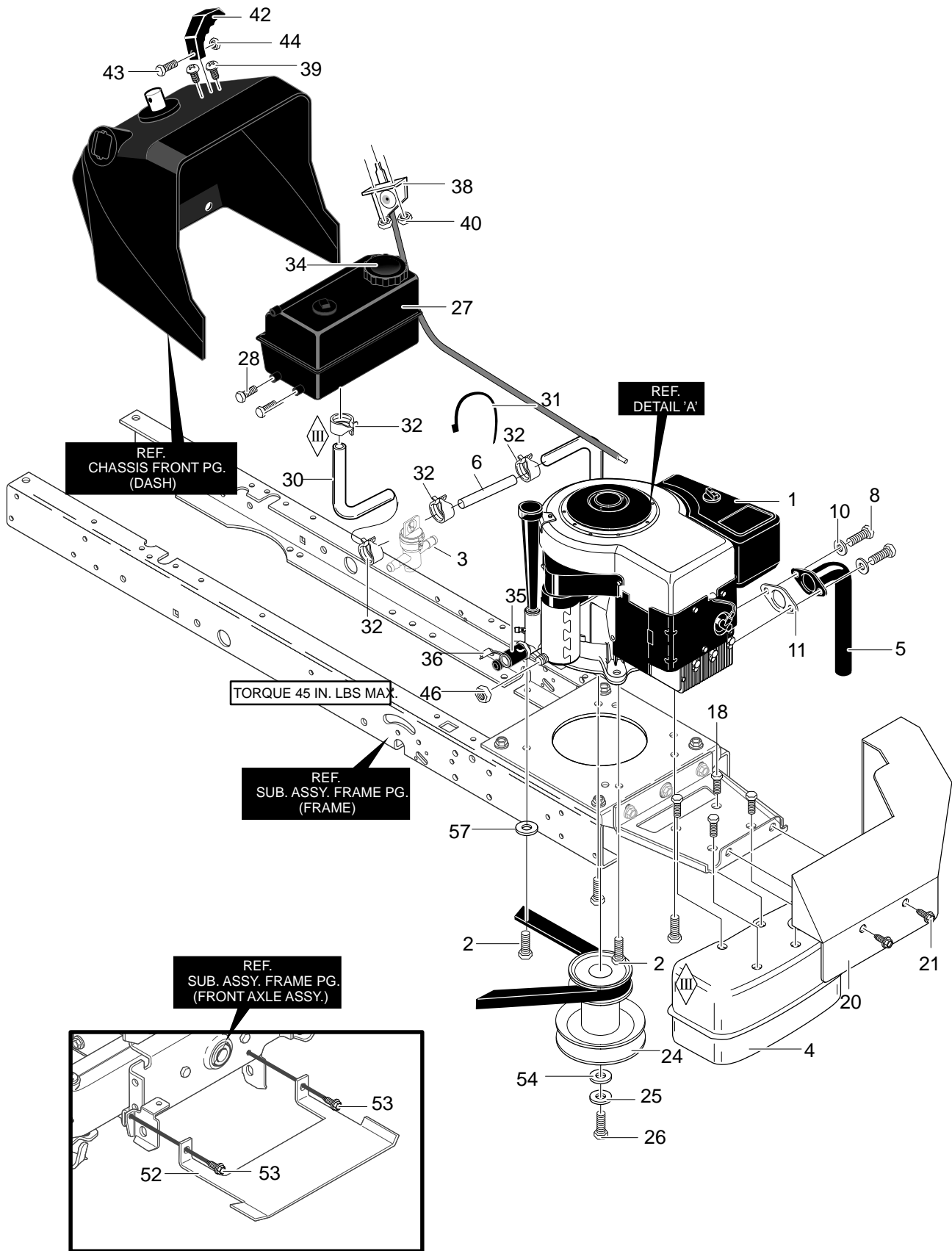

MODEL 403016x58A

REPAIR PARTS ENGINE AND CONTROL ASSEMBLY

Key No.	Description	Part No.	Key No.	Description	Part No.
1	12.5HP (See Engine Manual)	Engine	30	Gas line 8 Inches	48252
—	Clip, Speed	94951	31	Cable Tie	57444
2	Engine Bolt	0025x7	32	Clamp, Fuel Clamp	336890
3	Fuel Shut Off Valve	690494	34	Gas Cap	12501
4	Muffler, Super Low	94902	35	Oil Drain Valve Assembly	325547
5	Exhaust Pipe	94900	36	Cap, Oil Drain Valve	327422
6	Gas Line Tubing 3 Inches	309306	38	Throttle Control	95370
8	Screw, 5/16–18x.75	313676	39	Screw, 10–24x.63	711755
10	Washer, Hvsptlk	313679	40	Nut, #10–24	711754
11	Gasket, Muffler	91309	42	Knob, Throttle Control	94931
18	Screw, 1/4–20x.63	711642	43	Screw, #8–32	711750
20	Heat Shield Assembly	94904–821	44	Nut, #8–32	711748
21	Screw, 5/16–18x.75	711606	46	Nut, 1/4–20	711601
24	Stack Pulley	690456	52	Shield, Anti–Dehydration	95192–821
25	Washer, Regsptlk	120383	53	Screw, 5/16–18x.75	711606
26	Screw, 7/16–20	1X169	54	Washer, Flat	17x170
27	Tank, Fuel 1.5 Gal.	309853	57	Washer, Exlk	711668
28	Screw, 15TPIX	711681			

MODEL 403016x58A

REPAIR PARTS DECK ASSEMBLY

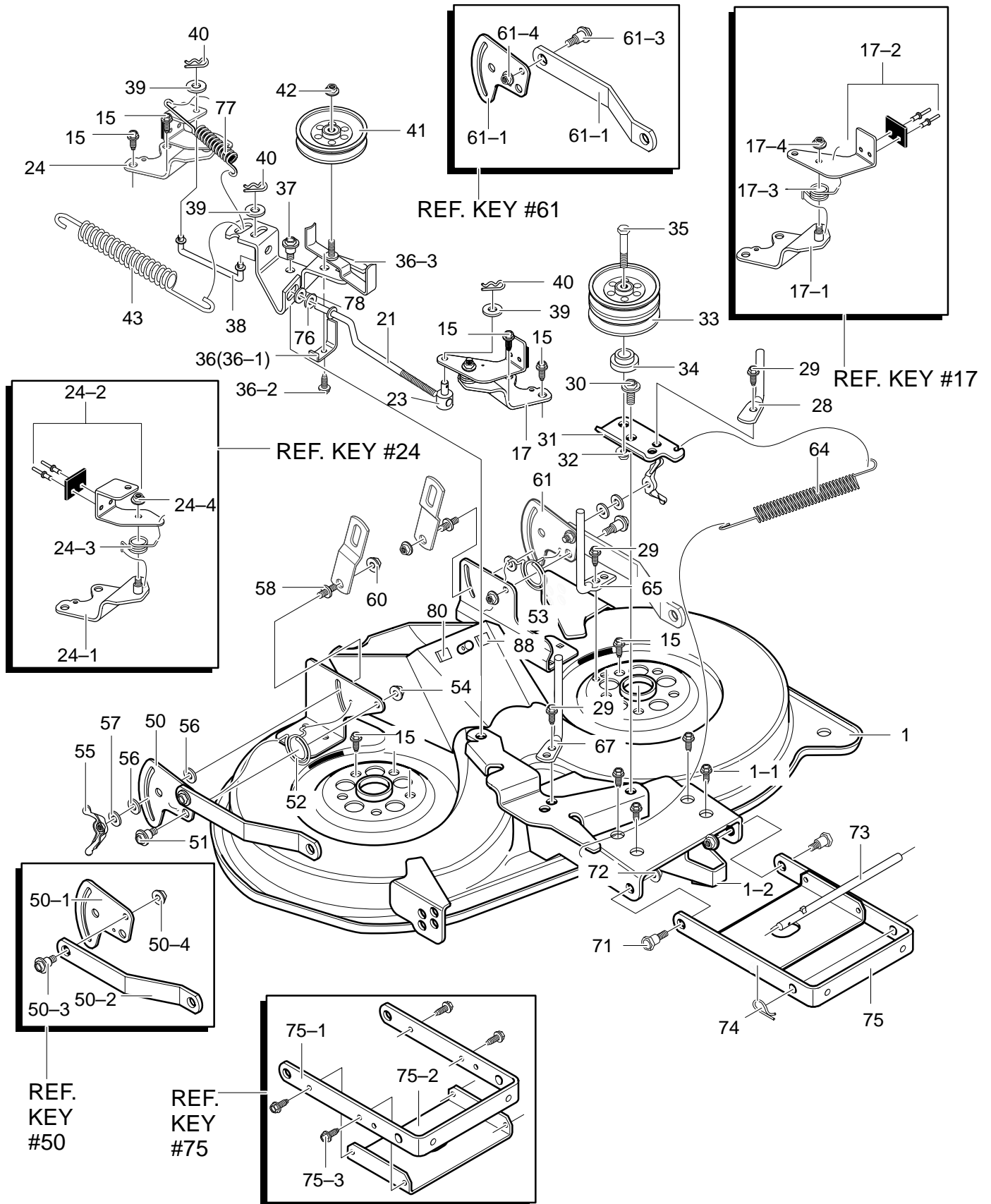

344276C

MODEL 403016x58A

REPAIR PARTS DECK ASSEMBLY

Key No.	Description	Part No.	Key No.	Description	Part No.
1	Housing, 40" Deck	690109-821	50-1	Plate-Suspension	94128
17	Brake Arm Assembly LH	94665-821	50-2	Suspension Bracket Rear	94055
17-1	Brake Support Assembly LH	94293	50-3	Bolt, Shoulder	710095
17-2	Brake Arm	94291	50-4	Nut, 3/8-16	710140
17-3	Spring, Torsion	710110	51	Bolt, Shoulder	711611
17-4	Nut, 5/16-18	710205	52	Spring, Torsion RH	710112
21	Link, Brake LH	690021	53	Spring, Torsion LH	710113
23	Nut, Adjusting	711591	54	Nut, 3/8-16	711622
24	Brake Arm Assembly RH	94664-821	55	Wingnut, 5/16-18	711600
24-1	Brake Support RH	94294	56	Pad, Friction	94137
24-2	Brake Arm RH	94292	57	Washer	711628
24-3	Spring, Torsion	710077	58	Pin, Hanger	711595
24-4	Nut, 5/16-18	710205	60	Nut, 3/8-16	711622
28	Belt Guide	711912	61	Assy., Plate Rear Sus Brkt., LH	690159-821
29	Screw, 5/16-18x.50	780055	61-1	Plate-Suspension	94128
30	Bolt, Shoulder	711613	61-2	Suspension Bracket, Rear	94055
31	Arm, Double Idler	94261-821	61-3	Bolt, Shoulder	710095
32	Nut, 3/8-16	711622	61-4	Nut, 3/8-16	710140
33	Pulley, Idler Double Vee	94279	64	Spring, Extension	710233
34	Spacer	94269	65	Belt Guide	711913
35	Screw, 3/8-16x3.00	711915	67	Belt Guide	690030
36	Idler Arm Assembly	94973-821	71	Shoulder Bolt	711611
36-1	Spring,-Belt Guide	94312	72	Nut, 3/8-16	711622
36-2	Screw, 1/4-20x.50	710264	73	Rod, Hanger	95295
36-3	Idler Arm	94298	74	Hair Pin	711676
37	Bolt, Shoulder	711613	75	Assembly, Bracket & Stiffener	690058-821
38	Link, Brake RH	690023	75-1	Bracket, Front Suspension	94058
39	Washer, Flat	712480	75-2	Stiffener	95057
40	Hair Pin	711682	75-3	Screw, 5/16-18x.75	710079
41	Pulley, Idler	690024	76	Flatwasher	583409
42	Nut, 3/8-16	711622	77	Spring, Extension	710658
43	Spring, Extension	710234	78	Washer, Flat	712480
50	Assy, Plate,Rear Sus Bkt RH	690158-821	80	Pad, Adhesive	318197

MODEL 403016x58A

REPAIR PARTS DECK ASSEMBLY

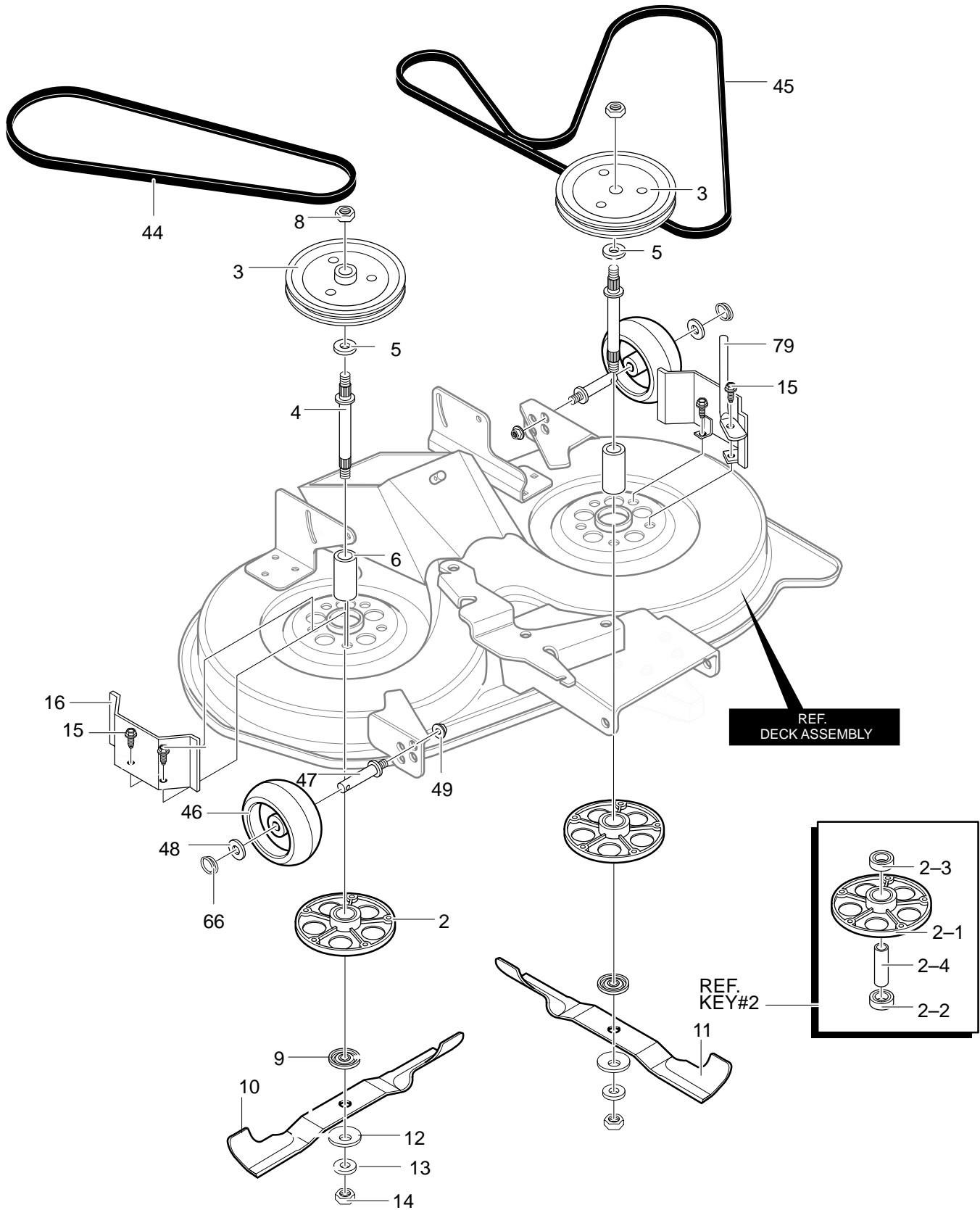

MODEL 403016x58A

REPAIR PARTS DECK ASSEMBLY

Key No.	Description	Part No.	Key No.	Description	Part No.
2	Assembly, Jackshaft Housing	94305	12	Washer, Bellville	17x166
2-1	Housing, Jackshaft	94282	13	Flatwasher	17x165
2-2	Bearing, Lower Jackshaft	92282	14	Nut, 9/16-18	711910
2-3	Bearing, Upper Jackshaft	92281	15	Screw, 3/8-16x1.00	711911
2-4	Spacer	90904	16	Pulley Cover	94288-821
3	Pulley, Deck	690020	44	Belt, V 46.5LG	710231
4	Jackshaft	91922	45	Belt, Deck	690071
5	Flatwasher	17x165	46	Gauge Wheel	92683
6	Spacer	91903	47	Shoulder Bolt	711746
8	Nut, 9/16-18	711910	48	Flatwasher	711615
9	Adapter, Deck	94207	49	Nut, 3/8-16	711622
10	Blade, LH	690499	66	Circle Pin	711764
11	Blade, RH	690500	79	Rod, Belt Guide	95280

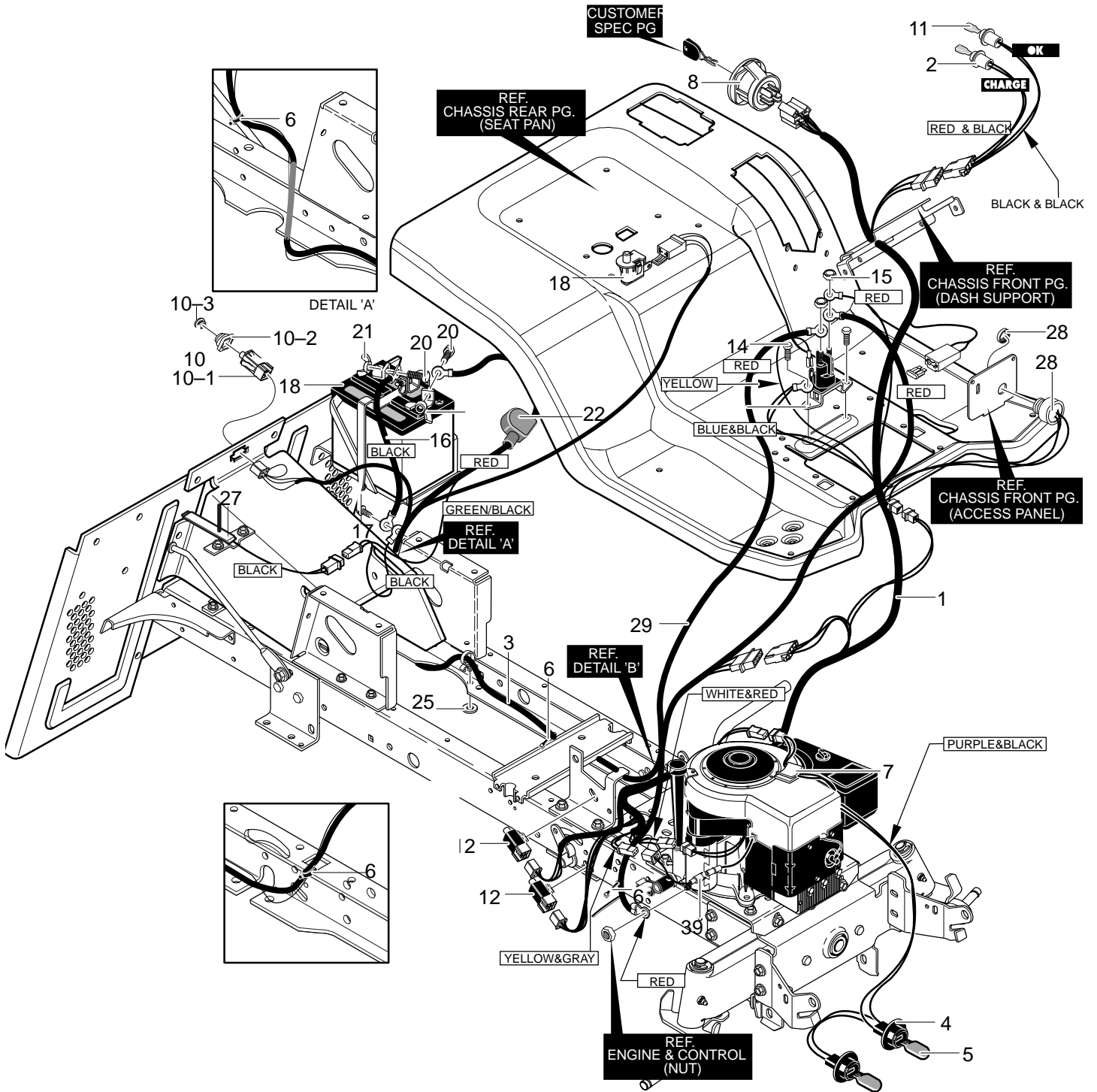

MODEL 403016x58A

REPAIR PARTS ELECTRICAL ASSEMBLY

Key No.	Description	Part No.	Key No.	Description	Part No.
1	Wire Harness	95378	14	Screw 1/4x.50	711619
2	Indicator Harness	690611	15	Nut, 1/4-20	711632
3	Rear Harness	95381	16	Ground Wire	95420
4	Wire Harness for Headlights	94103	17	Screw, 1/4x.50	711619
5	Bulb, Headlamp	52572	18	Seat Switch	94159
6	Cable Tie	57444	19	Battery 5 Plate	92739
7	Wire Clip, Adhesive	55939	20	Bolt, 1/4-20x.63	711680
8	Switch, Ignition	94762	21	Wing Nut	711636
10	Assy, Switch Double Pole Delta	690106	22	Battery Boot	335417
10-1	Switch, Double	320082	25	Flatwasher	711666
10-2	Boot, Switch	690074	27	Tape Switch	95330
10-3	Switch Cap	690075	28	Buzzer, For Bag Full	95391
11	Bulb, Indicator	57769	29	Wire, Lead Solenoid to Starter	711579
12	Switch, Limit	94136	39	Harness Adapter	94348
13	Solenoid	94613	—	15 Amp Fuse	302031

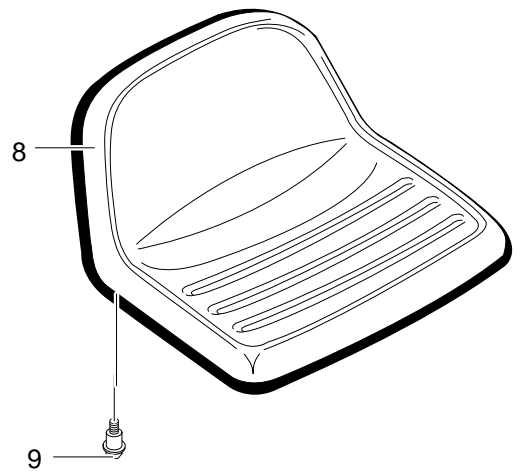
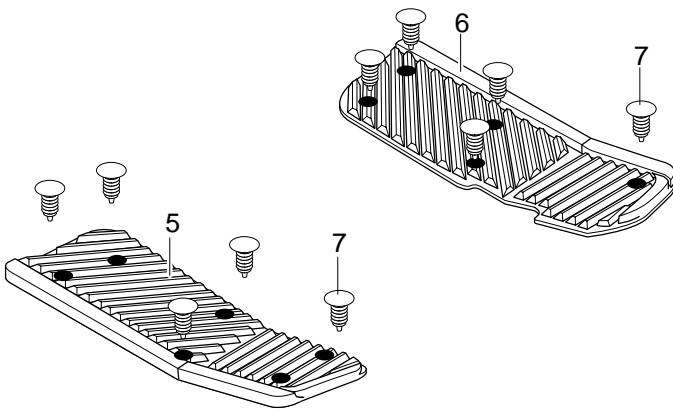
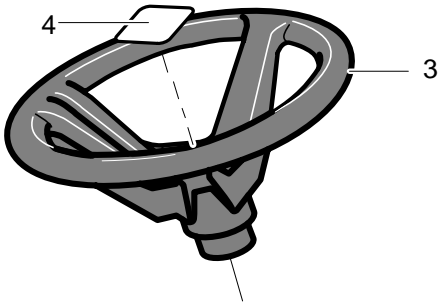
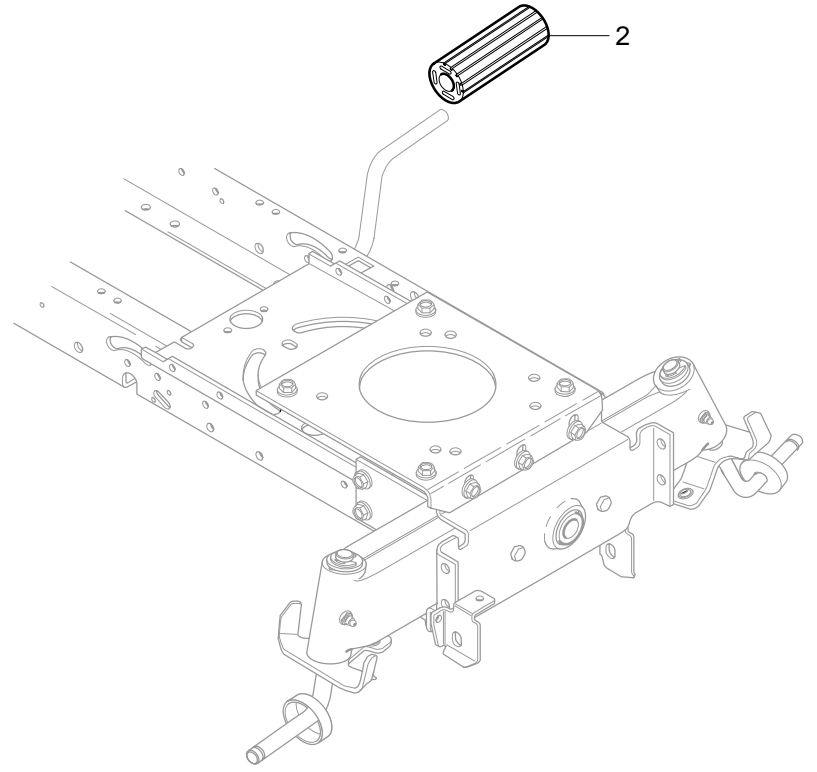
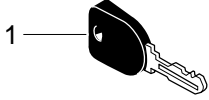

Key No.	Description	Part No.
1	Ignition Key	327349
2	Cover, Pedal Brake/Clutch	21544
3	Steering Wheel	95184
4	Insert, 4-Spoke	711325
5	Footrest Pad RH	95438
6	Footrest Pad LH	95437
7	Ratchet Fastener	311087
8	Seat	95444
9	Shoulder Bolt 5/16-18	711654