

MODEL 22516X194B

REPAIR PARTS

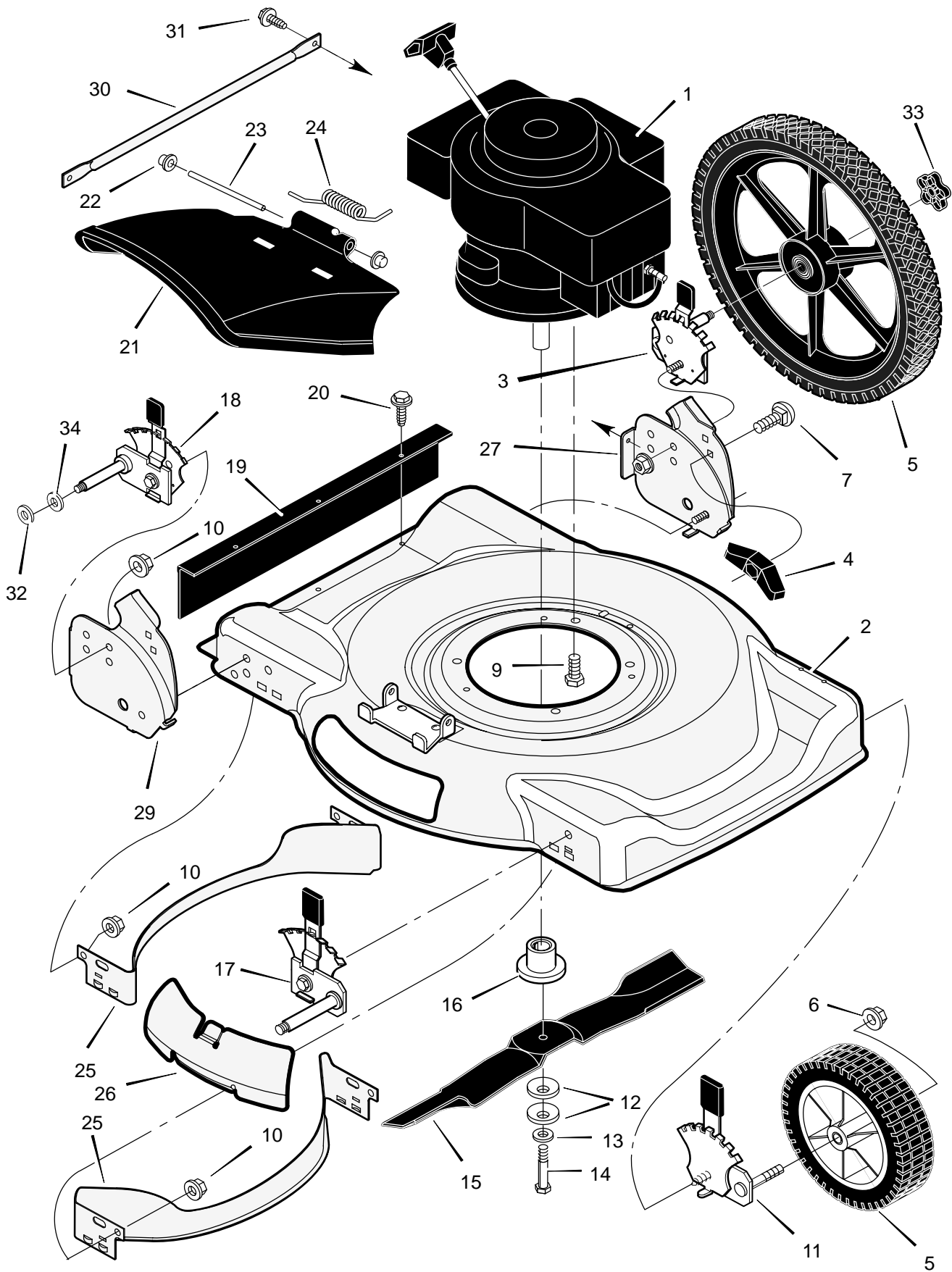

MODEL 22516X194B

REPAIR PARTS

KEY NO.	DESCRIPTION	PART NO.
1	Engine *	_____
2	Housing	776024
3	Height Adjuster, Left Rear	672645
4	Knob	71495
5	Wheel and Tire –Front	672060
5	Wheel and Tire –Rear	672074
6	Locknut, Flange	15x84
7	Bolt, Carriage	2x81
9	Bolt, Engine	25x6
10	Nut	15x68
11	Height Adjuster, Left Front	672601
12	Washer, Belleville	17x137
13	Washer	17x124
14	Bolt, Hex	1x142
15	Blade	1101120E701
16	Adapter, Blade	71056
17	Height Adjuster, Right Front	672600
18	Height Adjuster, Right Rear	672644
19	Guard, Rear	672738
20	Screw	26x245
21	Deflector, Chute	672421
22	Push–On Cap	28x42
23	Pin, Pivot	215x11 Z
24	Spring	166x5
25	Baffle	672744E701
26	Plate, Mulcher (<i>Optional Accessory</i>)	672422 Z
27	Bracket, Left Handle	1101305E700
29	Bracket, Right Handle	1101304E700
30	Brace	672728E700
31	Screw	26x263
32	Washer	17x91 Z
33	Knob, Axle	672449
34	Washer, Spring	20x3
–	Book, Instruction	F–010400L

MODEL 22516X194B

REPAIR PARTS

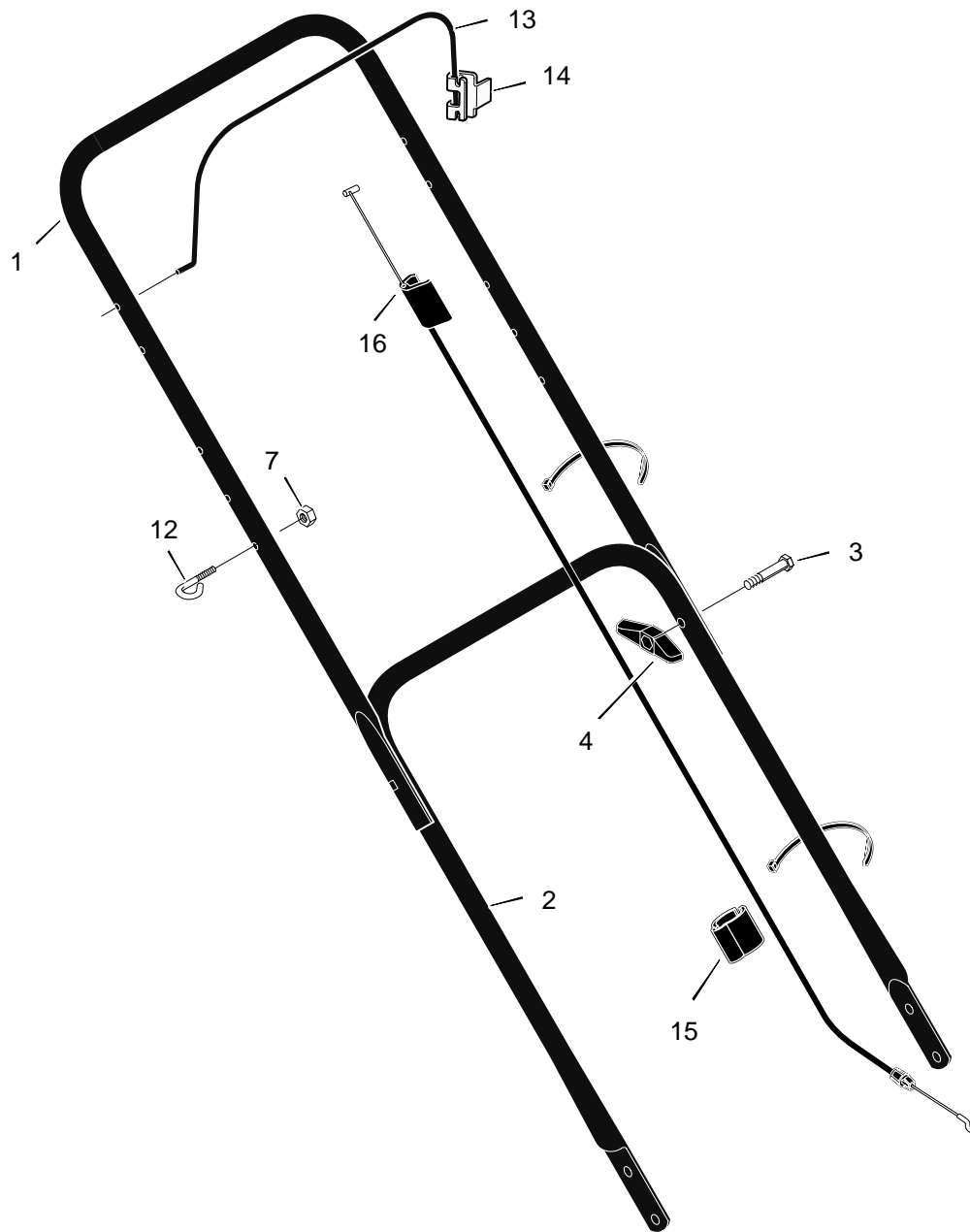

KEY NO.	DESCRIPTION	PART NO.	KEY NO.	DESCRIPTION	PART NO.
1	Handle, Upper (Black)	071581E701	12	Guide, Rope	71530
2	Handle, Lower (Black)	71137E701	13	Engine Stop Lever	43653E700
3	Bolt	2x77	14	Bracket, Stop Lever	43628 BC
4	Knob, Plastic	71294	15	Fastener, Cable	1101352
7	Locknut	15x116	16	Engine Stop Cable	672840